

# JVC

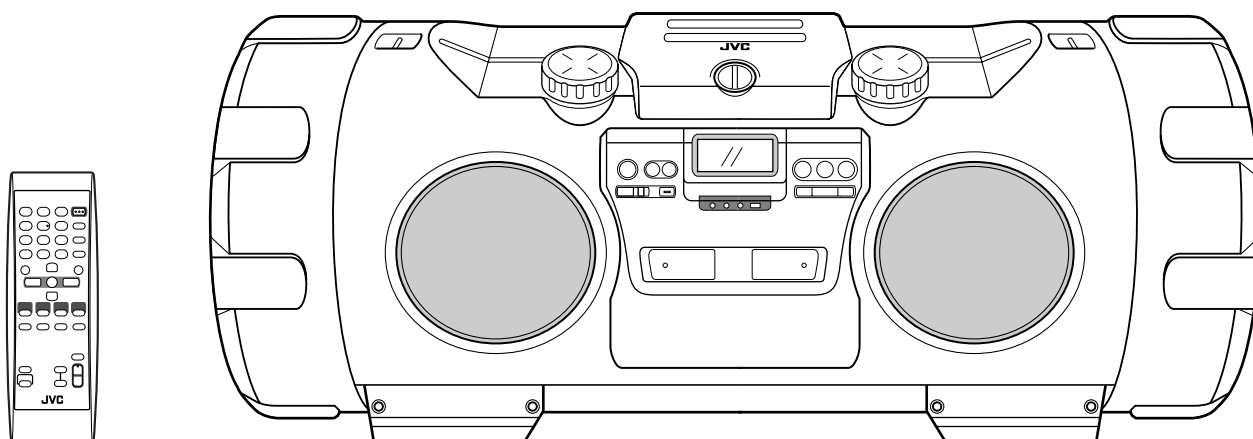

## POWERED WOOFER CD SYSTEM

# RV-NB20B/RV-NB20W



**MP3**  
PLAYBACK

COMPACT  
**disc**  
DIGITAL AUDIO



## INSTRUCTIONS

### For Customer Use:

Enter below the Model No. and Serial No. which are located either on the rear, bottom or side of the cabinet. Retain this information for future reference.

Model No. \_\_\_\_\_

Serial No. \_\_\_\_\_



LVT1614-001A

[J]

# Warnings, Cautions and Others

## Mises en garde, précautions et indications diverses

(For U.S.A.)

**CAUTION**  
RISK OF ELECTRIC SHOCK  
DO NOT OPEN

CAUTION: TO REDUCE THE RISK OF ELECTRIC SHOCK,  
DO NOT REMOVE COVER (OR BACK).  
NO USER SERVICEABLE PARTS INSIDE.  
REFER SERVICING TO QUALIFIED SERVICE PERSONNEL.

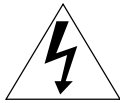
 The lightning flash with arrowhead symbol, within an equilateral triangle is intended to alert the user to the presence of uninsulated "dangerous voltage" within the product's enclosure that may be of sufficient magnitude to constitute a risk of electric shock to persons.

 The exclamation point within an equilateral triangle is intended to alert the user to the presence of important operating and maintenance (servicing) instructions in the literature accompanying the appliance.

(For U.S.A.)

This equipment has been tested and found to comply with the limits for a Class B digital device, pursuant to part 15 of the FCC Rules. These limits are designed to provide reasonable protection against harmful interference in a residential installation. This equipment generates, uses, and can radiate radio frequency energy and, if not installed and used in accordance with the instructions, may cause harmful interference to radio communications. However, there is no guarantee that interference will not occur in a particular installation. If this equipment does cause harmful interference to radio or television reception, which can be determined by turning the equipment off and on, the user is encouraged to try to correct the interference by one of the following measures: Reorient or relocate the receiving antenna. Increase the separation between the equipment and receiver. Connect the equipment into an outlet on a circuit different from that to which the receiver is connected. Consult the dealer or an experienced radio/TV technician for help.

**Caution**  
Changes or modifications not approved by JVC could void the user's authority to operate the equipment.

(For U.S.A.)

**WARNING: TO REDUCE THE RISK OF FIRE OR ELECTRIC SHOCK, DO NOT EXPOSE THIS APPLIANCE TO RAIN OR MOISTURE.**

**For Canada/pour le Canada**

THIS DIGITAL APPARATUS DOES NOT EXCEED THE CLASS B LIMITS FOR RADIO NOISE EMISSIONS FROM DIGITAL APPARATUS AS SET OUT IN THE INTERFERENCE-CAUSING EQUIPMENT STANDARD ENTITLED "DIGITAL APPARATUS," ICES-003 OF THE DEPARTMENT OF COMMUNICATIONS.

CET APPAREIL NUMERIQUE RESPECTE LES LIMITES DE BRUITS RADIOELECTRIQUES APPLICABLES AUX APPAREILS NUMERIQUES DE CLASSE B PRESCRITES DANS LA NORME SUR LE MATERIEL BROUILLEUR: "APPAREILS NUMERIQUES", NMB-003 EDICTEE PAR LE MINISTRE DES COMMUNICATIONS.

### CAUTION— ON/STANDBY button!

Disconnect the mains plug to shut the power off completely (the STANDBY lamp goes off). When installing the apparatus, ensure that the plug is easily accessible. The  ON/STANDBY button in any position does not disconnect the mains line.

- When the unit is on standby, the STANDBY lamp lights red.
- When the unit is turned on, the STANDBY lamp goes off.

The power can be remote controlled.

### ATTENTION—Touche ON/STANDBY!

Déconnectez la fiche secteur pour mettre l'appareil complètement hors tension (le témoin STANDBY s'éteint). Lors de l'installation de l'appareil, assurez-vous que la fiche soit facilement accessible. La touche  ON/STANDBY dans n'importe quelle position ne déconnecte pas l'appareil du secteur.

- Quand l'appareil est en mode d'attente, le témoin STANDBY est allumé en rouge.
- Quand l'appareil est sous tension, le témoin STANDBY s'éteint.

L'alimentation ne peut pas être commandée à distance.

### CAUTION

To reduce the risk of electrical shocks, fire, etc.:

1. Do not remove screws, covers or cabinet.
2. Do not expose this appliance to rain or moisture.

### ATTENTION

Afin d'éviter tout risque d'électrocution, d'incendie, etc.:

1. Ne pas enlever les vis ni les panneaux et ne pas ouvrir le coffret de l'appareil.
2. Ne pas exposer l'appareil à la pluie ni à l'humidité.

## IMPORTANT FOR LASER PRODUCTS

1. CLASS 1 LASER PRODUCT
2. **CAUTION:** Do not open the top cover. There are no user serviceable parts inside the unit; leave all servicing to qualified service personnel.
3. **CAUTION:**  
(For U.S.A.) Visible and/or invisible class II laser radiation when open. Do not stare into beam.  
(For Canada) Visible and/or invisible class 1M laser radiation when open. Do not view directly with optical instruments.
4. REPRODUCTION OF LABEL: CAUTION LABEL, PLACED INSIDE THE UNIT.

## IMPORTANT POUR PRODUITS LASER

1. PRODUIT LASER CLASSE 1
2. **ATTENTION:** N'ouvrez pas le couvercle supérieur. Il n'y a aucune pièce réparable par l'utilisateur à l'intérieur de l'appareil; confiez toute réparation à un personnel qualifié.
3. **ATTENTION:**  
(Pour les Etats-Unis) Radiation laser de classe II visibles et/ou invisible si l'appareil est ouvert. Ne regardez pas le rayon.  
(Pour le Canada) Rayonnement laser visible et/ou invisible de classe 1M une fois ouvert. Ne pas regarder directement avec des instruments optiques.
4. REPRODUCTION DE L'ÉTIQUETTE: ÉTIQUETTE DE PRÉCAUTION PLACÉE À L'INTERIEUR DE L'APPAREIL.

<b>CAUTION</b> VISIBLE AND/OR INVISIBLE CLASS 1M LASER RADIATION WHEN OPEN. DO NOT VIEW DIRECTLY WITH OPTICAL INSTRUMENTS. IEC30825-1:2001 (ENG)	<b>ATTENTION</b> RAYONNEMENT LASER VISIBLE ET/OU INVISIBLE DE CLASSE 1M UNE FOIS OUVERT. NE PAS REGARDER DIRECTEMENT AVEC DES INSTRUMENTS OPTIQUES. (FRA)	<b>AVISO</b> RADIACIÓN LASER DE CLASE 1M VISIBLE Y/O INVISIBLE CUANDO ESTA ABIERTO. NO MIRAR DIRECTAMENTE CON INSTRUMENTAL OPTICO. (ESP)	<b>VARNING</b> SYNLIG OCH/ELLER OSYNLIG LASERSTRÅLNING, KLASS 1M, NÅR DENNA DEL ÄR ÖPPNAD. RETRAKTA EJ STRÅLEN MED OPTISKA INSTRUMENT. (SWE)	<b>注意</b> ここを覗くと有害視 及びまたはは不可視 のクラス1M レーザー放射が 出ます。 光学機器で直接 見ないでください。 (JPN)	<b>CAUTION</b> VISIBLE AND/OR INVISIBLE CLASS II LASER RADIATION WHEN OPEN. DO NOT STARE INTO BEAM. FDA 21 CFR (ENG) LV44603-003A
--	--	---	---	---	---

### CAUTION:

- Do not block the ventilation openings or holes. (If the ventilation openings or holes are blocked by a newspaper or cloth, etc., the heat may not be able to get out.)
- Do not place any naked flame sources, such as lighted candles, on the apparatus.
- When discarding batteries, environmental problems must be considered and local rules or laws governing the disposal of these batteries must be followed strictly.
- Do not expose this apparatus to rain, moisture, dripping or splashing and that no objects filled with liquids, such as vases, shall be placed on the apparatus.

### ATTENTION:

- Ne bloquez pas les orifices ou les trous de ventilation. (Si les orifices ou les trous de ventilation sont bloqués par un journal un tissu, etc., la chaleur peut ne pas être évacuée correctement de l'appareil.)
- Ne placez aucune source de flamme nue, telle qu'une bougie, sur l'appareil.
- Lors de la mise au rebut des piles, veuillez prendre en considération les problèmes de l'environnement et suivre strictement les règles et les lois locales sur la mise au rebut des piles.
- N'exposez pas cet appareil à la pluie, à l'humidité, à un égouttement ou à des éclaboussures et ne placez pas des objets remplis de liquide, tels qu'un vase, sur l'appareil.

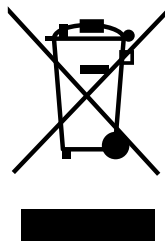

[European Union Only]  
[Union européenne seulement]

Thank you for purchasing the JVC Powered Woofer CD System.

Before operating this system, read this manual carefully and thoroughly to obtain the best possible performance from your system, and retain this manual for future reference.

## Features

Here are some of the things that make your system both powerful and simple to use.

- **General**
  - With JVC's **COMPU PLAY** you can turn on the system and start playing the iPod connected to the iPod jack with a single touch, as well as the radio and disc player. (Only when AC power is used.)
  - Shoulder strap with carrying case for the iPod and carrying handle
  - Active Clear Sound (ACS) circuit for enhancing sound reproduction
  - Super woofer volume control that provides powerful bass
  - Sound mode control—reproducing various sound fields
  - Remote control unit that operates the disc, tuner, and iPod functions
  - Locking mechanism for disc door
  - Microphone/guitar input
- With Quick Portable Link (QP Link) function, the system automatically switches the source to AUX when the connected auxiliary equipment starts to play.
- Disc playback mode includes Skip Play, Search Play, Repeat Play, Random Play, and Program Play.
- A 45-station preset capability (30 stations in FM band and 15 stations in AM band) in addition to auto-seek and manual tuning.
- Clock/timer functions, timer on/off with preset volume function, and sleep timer.



iPod is a trademark of Apple Computer, Inc., registered in the U.S. and other countries.

## IMPORTANT CAUTIONS

### 1. Where to place the system

- Select a place which is level, dry and neither too hot nor too cold (between 5°C and 35°C or 41°F and 95°F).
- Leave sufficient distance between the system and a TV.
- Do not use the system in a place subject to vibrations.

### 2. Power cord

- Do not handle the power cord with wet hands!
- Some power is always consumed as long as the power cord is connected to the wall outlet.
- When unplugging the system from the wall outlet, always pull the plug, not the power cord.

### 3. When carrying the system

- Remove a disc from the system.
- Disconnect all the cords from the system.

### 4. Malfunctions, etc.

- There are no user serviceable parts inside. In case of system failure, unplug the power cord and consult your dealer.
- Do not insert any foreign object into the system.
- The system is not waterproof or dust proof.

## Table of contents

Features .....	1	Listening to the iPod .....	13
IMPORTANT CAUTIONS .....	1	Listening to auxiliary equipment .....	14
Index of parts and controls .....	2	Using the microphone/guitar .....	15
Getting started .....	3	Using the timer .....	15
Basic operations .....	7	Care and maintenance .....	17
Listening to the radio .....	9	Troubleshooting .....	17
Playing back discs .....	10	Specifications .....	18

# Index of parts and controls

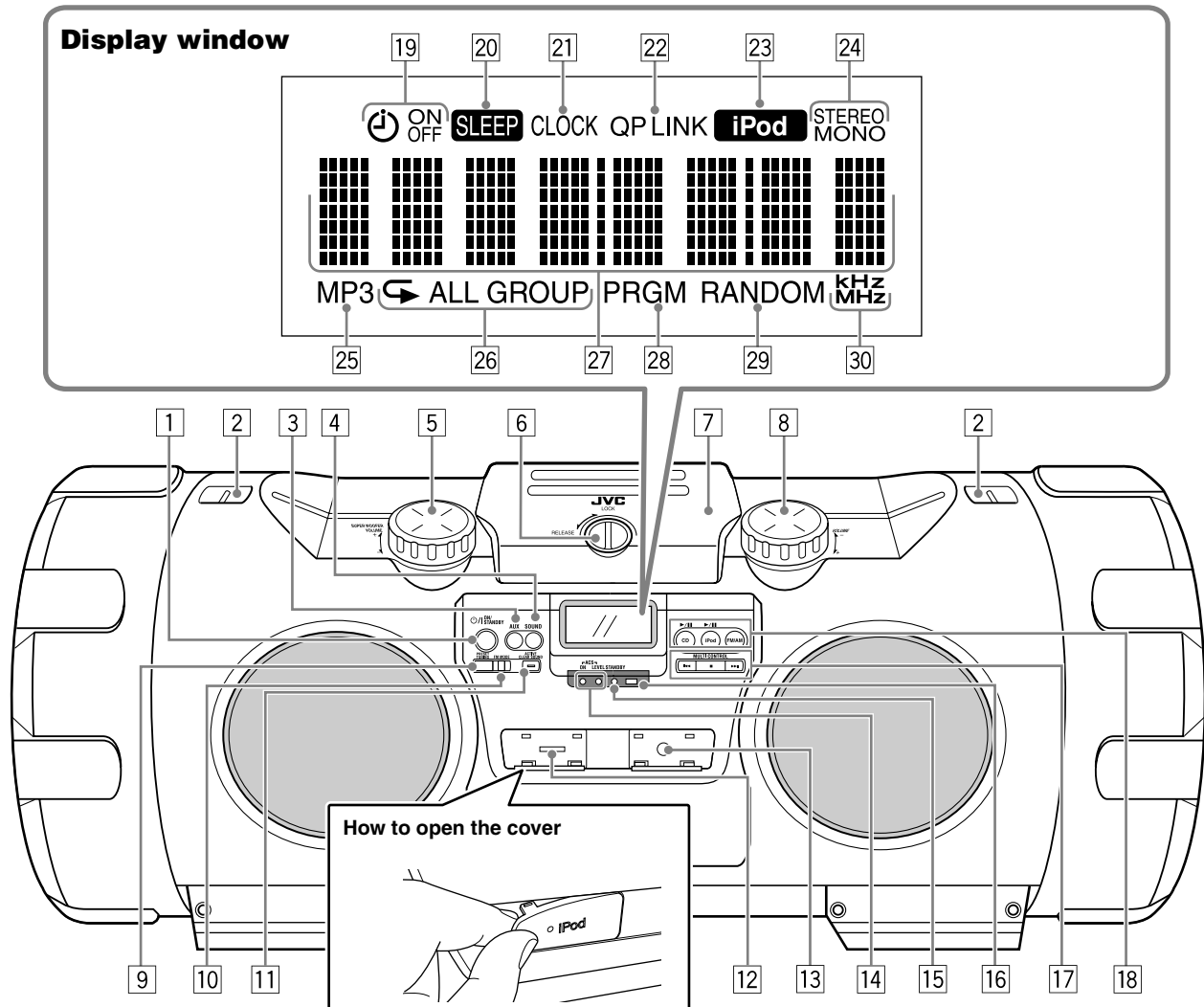

See pages in parentheses for details.

- 1  $\text{\textcircled{I}}$ /ION/STANDBY button (7)
- 2 Shoulder strap hooks (4)
- 3 AUX button (3, 14)
  - Pressing this button also turns on the system.
- 4 SOUND button (8)
- 5 SUPER WOOFER VOLUME +/- control knob (8)
- 6 LOCK/RELEASE knob (for disc) (10)
- 7 Disc compartment door (10)
- 8 VOLUME +/- control knob (7)
- 9 PRESET TUNING button (9)
- 10 FM MODE button (9)
- 11 ACTIVE CLEAR SOUND button (8)
- 12 iPod jack (6)
- 13 AUX jack (6)
- 14 ACS (Active Clear Sound) indicators (8)
  - ON, LEVEL
- 15 STANDBY lamp (7)
- 16 Remote sensor (4)
- 17 MULTI CONTROL buttons (9 – 13)
  - $\text{\textcircled{L}}$  (reverse skip),  $\text{\textcircled{R}}$ ,  $\text{\textcircled{R}}$  (forward skip)
- 18 Source and play mode buttons (3, 9 – 13)
  - CD  $\text{\textcircled{C}}$ / $\text{\textcircled{I}}$ , iPod  $\text{\textcircled{I}}$ / $\text{\textcircled{I}}$ , FM/AM
  - Pressing one of these buttons also turns on the system.

## Display window

- 19 Timer indicators (16)
  - $\text{\textcircled{I}}$  (timer), ON, OFF
- 20 SLEEP indicator (15)
- 21 CLOCK indicator (8, 15)
- 22 QP LINK indicator (14)
- 23 iPod indicator (13)
- 24 FM mode indicators (9)
  - STEREO, MONO
- 25 MP3 indicator (11)
- 26 Repeat indicators (12)
  - $\text{\textcircled{C}}$ , ALL, GROUP
- 27 Main display
- 28 PRGM (program) indicator (12)
- 29 RANDOM indicator (12)
- 30 Frequency unit indicators (8, 9)
  - kHz, MHz

## Remote control

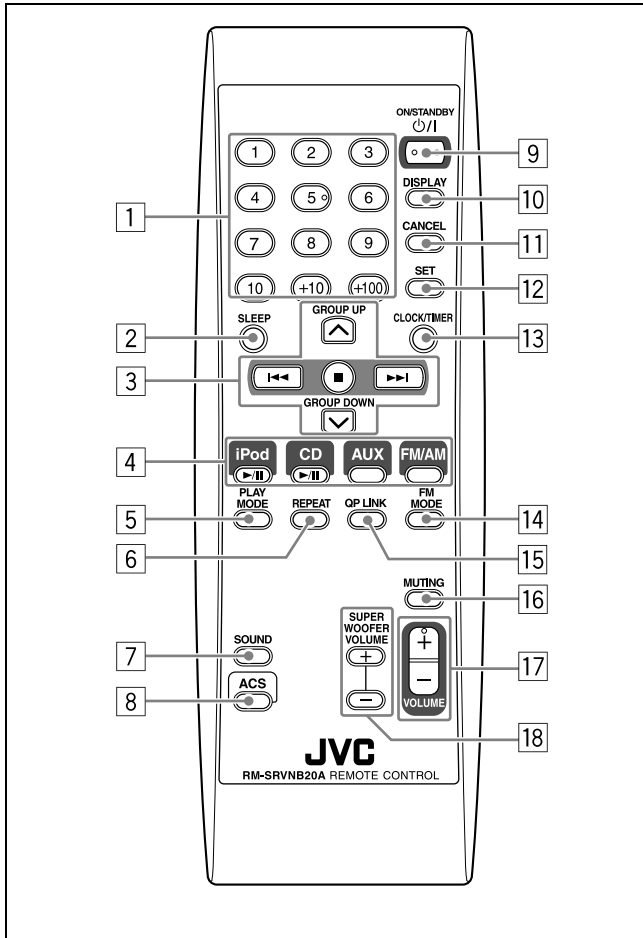

See pages in parentheses for details.

- 1 Number buttons (9, 11)
- 2 SLEEP button (15)
- 3 Multi control buttons (9, 11, 15, 16)
  - ^ GROUP UP, v GROUP DOWN
  - ◀◀, ■, ▶▶
- 4 Source buttons (3, 9 – 14)
  - iPod ▶/||, CD ▶/||, AUX, FM/AMPressing one of these buttons also turns on the system.
- 5 PLAY MODE button (12)
- 6 REPEAT button (12)
- 7 SOUND button (8)
- 8 ACS (Active Clear Sound) button (8)
- 9 ON/STANDBY button (7, 15, 16)
- 10 DISPLAY button (8)
- 11 CANCEL button (12, 15, 16)
- 12 SET button (10, 15, 16)
- 13 CLOCK/TIMER button (15, 16)
- 14 FM MODE button (9)
- 15 QP LINK button (14)
- 16 MUTING button (8)
- 17 VOLUME +/- button (7)
- 18 SUPER WOOFER VOLUME +/- buttons (8)

## COMPU PLAY — One Touch Operation

With One Touch Operation you can play a disc, an iPod, or turn on the radio with a single press of the play button for that function. The system turns on and starts playing the source if it is ready.

The COMPU PLAY buttons are: **On the system and remote control**

- iPod ▶/|| button
- CD ▶/|| button
- AUX button
- FM/AM button

**Note:** The COMPU PLAY feature is not effective when the system is operated on batteries or car battery (DC12V).

## Getting started

### Accessories

Check that you have all the following items, which are supplied for the system.

- Power cord (1)
- Remote control (1)
- Shoulder strap with carrying case for the iPod (1)
- iPod cable (1)
- iPod stand (1)

If any of these items are missing, contact your dealer immediately.

## Carrying the system

### ■ Using the carrying handles

Be sure to hold both handles when you carry the system. If you carry the system by only one handle, because of the length of the system, the end may drag on the ground and be damaged as a result. Do not lift the system by the woofer ducts, and do not insert any foreign objects into them.

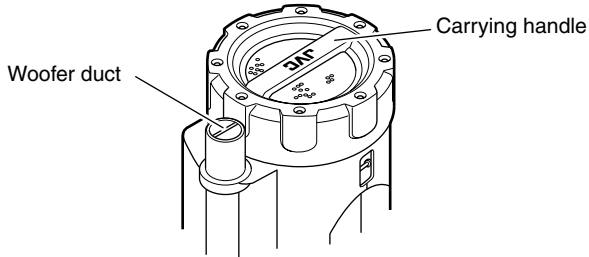

### ■ Using the shoulder strap

Attach the supplied shoulder strap (adjustable in length) to each end of the system as illustrated.

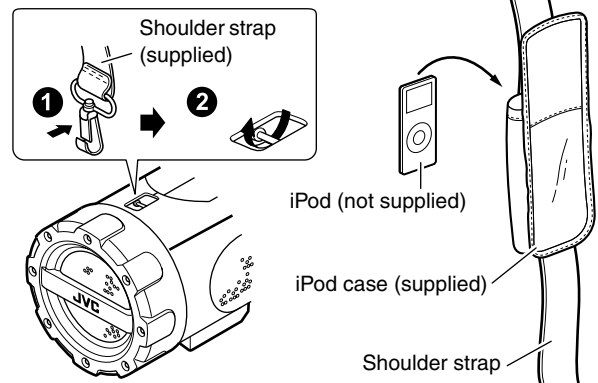

To detach the shoulder strap, press in the metal fitting and unhook it from the shaft.

## Using the remote control — RM-SRVNB20A

### ■ Installing the batteries

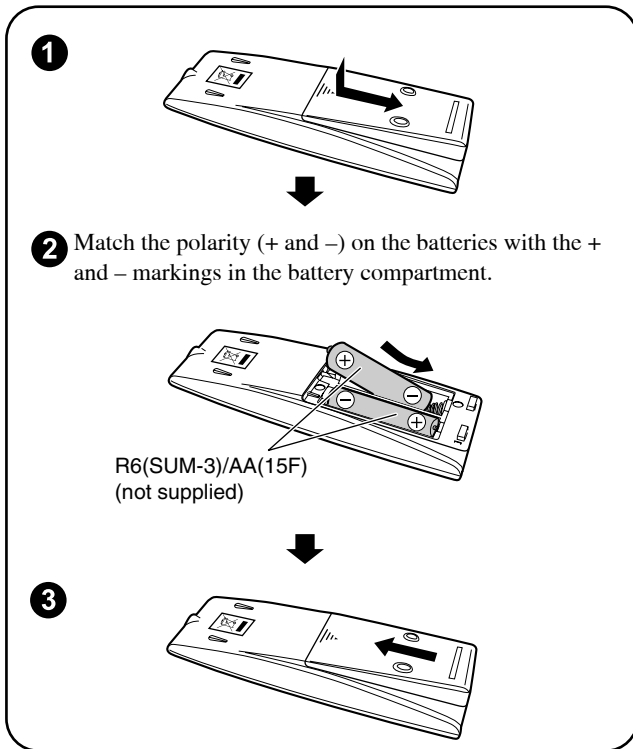

### CAUTION:

To avoid battery leakage or explosion:

- Remove batteries when the remote control is not in use for an extended period of time.
- When you need to replace the batteries, replace both batteries at the same time with new ones.
- Do not use different types of batteries together.

Point the remote control at the remote sensor on the system's control panel (from a distance of up to 7 m or 23 feet). If you point the remote control from the slant direction, the distance will be shortened.

- Do not expose the remote sensor to strong direct sunlight or artificial lighting.
- Make sure there are no obstacles between the remote sensor and the remote control.

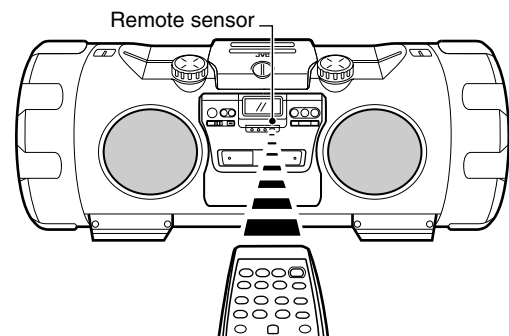

## Checking the type of your iPod

This system has been designed to operate an iPod (see page 13).

### Compatible iPod types:

iPod nano 1G/2G/4G
iPod mini
iPod (4th Generation) 20G/40G
iPod photo (4th Generation) 20G/30G/40G/60G
iPod video (5th Generation) 30G/60G

If the iPod does not play correctly, please update your iPod Software to the latest version.

- For details about updating your iPod, check on the Apple web site <<http://www.apple.com>>.

# Connections

**CAUTION:** Make all connection before plugging the system into an AC power outlet.

■ **Connecting the microphone/guitar**  
(See page 15.)

(Not supplied)

(Not supplied)

■ **Connecting the headphones** (See page 7.)

(Not supplied)

Stereo mini plug

■ **Connecting to the car battery**

Car adapter JVC model CA-R120 (not supplied)

② To car's cigarette lighter socket (DC12V)

①

- CAUTIONS:**
- Be sure to use the specified car adapter (JVC model CA-R120) to prevent mishaps or damage resulting from different polarity design.
  - For safety, stop the car before performing operations.
  - Be sure to start the engine when you use the car adapter; otherwise, the car battery will be exhausted.
  - During transport, stabilize the system in a box, etc.
  - To prevent malfunctions, do not leave the system in a car for a long time.
  - If the power is supplied through the car battery, the display will be blank with the system turned off (at standby).

**Unplug the AC power cord from the system to supply the power through the car battery; otherwise, the system does not work.**

■ **Connecting the AC power cord**

Power cord

**CAUTIONS:**

- **ONLY USE THE JVC POWER CORD PROVIDED FOR THIS SYSTEM TO AVOID MALFUNCTION OR DAMAGE TO THE SYSTEM.**
- **BE SURE TO UNPLUG THE POWER CORD FROM THE OUTLET WHEN GOING OUT OR WHEN THE SYSTEM IS NOT IN USE FOR AN EXTENDED PERIOD OF TIME.**

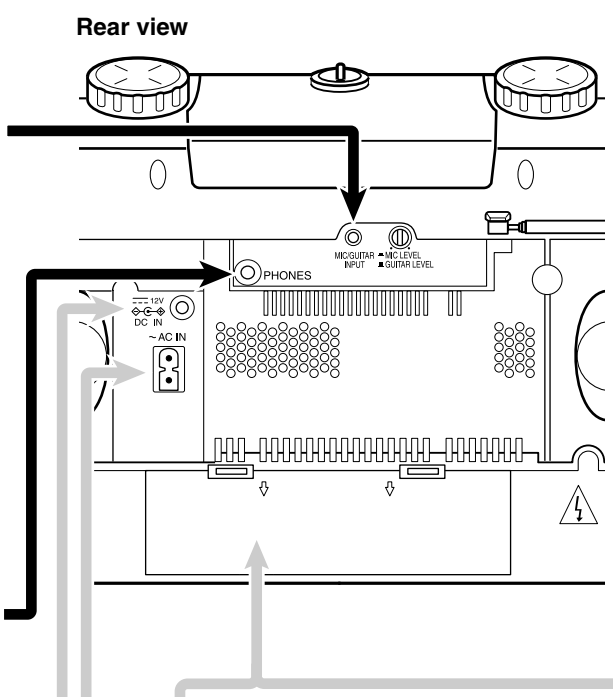

■ **Memory backup batteries**

- Battery cover
- Match the polarity (+ and -) on the batteries with the + and - markings in the battery compartment.
- "R6(SUM-3)/AA(15F)" size batteries (not supplied)



### ■ Connecting the iPod (See page 13.)

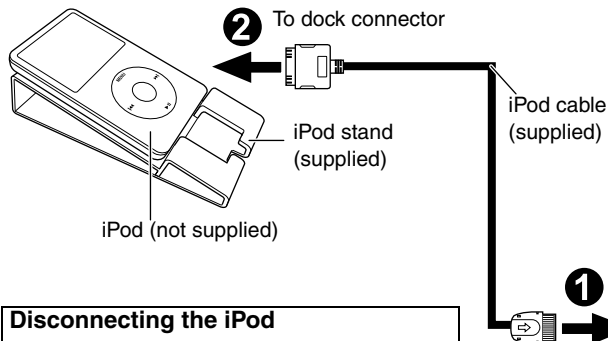

#### Disconnecting the iPod

- When disconnecting the iPod, make sure the system is turned off.
- To remove the iPod cable from the iPod, hold the buttons on the sides and pull.

### ■ Connecting the auxiliary equipment (See page 14.)

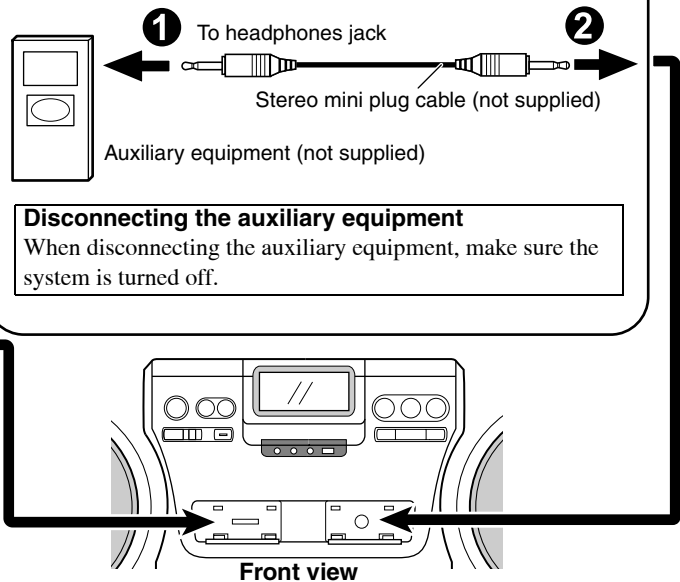

#### Disconnecting the auxiliary equipment

When disconnecting the auxiliary equipment, make sure the system is turned off.

To remove the batteries, remove battery “3” first.

#### Notes:

- The memory backup batteries will not be consumed as long as the power is supplied from an AC outlet, loaded 10 batteries, or car battery (DC12V). However, if no power is supplied to the system, the memory backup batteries should be replaced with new ones approximately every 12 months to securely maintain the contents of the memory.
- Before replacing the memory backup batteries, always connect the AC power cord to the system to prevent the contents of memory from being erased.
- When a power failure occurs, the time indication disappears from the display to save the battery power of the memory backup batteries.

#### CAUTION:

- To avoid battery leakage or explosion:
- When you need to replace the batteries, replace all batteries at the same time with new ones. Before replacing, you need to supply AC power to the system.
  - Do not use an old battery with new ones.
  - Do not use different types of batteries together.

### ■ Operating the system on batteries

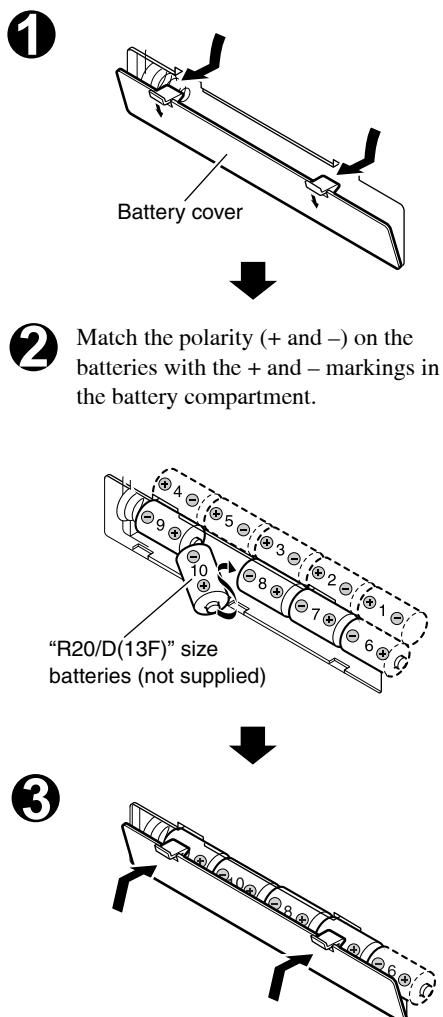

To remove the batteries, remove battery “10” first.

#### Notes:

- When you operate the system on mains (AC) power or on car battery (DC12V), the power source automatically switches from batteries to AC or DC12V. However, you should remove the 10 batteries when operating on AC power or car battery (DC12V).
- When the batteries are exhausted, the following symptoms will occur:
  - Mistracking occurs during disc playback.
  - “DC OFF” flashes on the display, then the power goes off.
 If this happens, replace the batteries.

#### CAUTION:

To avoid battery leakage or explosion:

- Remove the 10 batteries when the system is not in use for an extended period of time.
- When you need to replace the batteries, replace all batteries at the same time with new ones.
- Do not use different types of batteries together.
- If the power is supplied through the batteries, the display will be blank with the system turned off (at standby).

**Unplug the AC power cord from the system to supply the power through the batteries; otherwise, the system does not work.**

# Basic operations

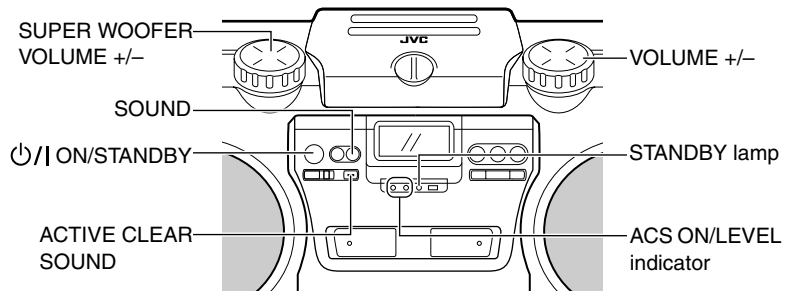
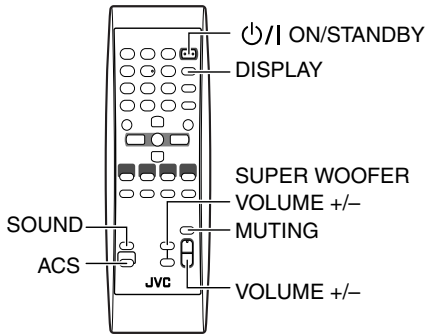

## Turning the power on and off

**Note:** The lighting condition for the STANDBY lamp and for the display differs depending on the power source.

Power source	STANDBY lamp/display
<ul style="list-style-type: none"> <li>AC power</li> </ul>	<ul style="list-style-type: none"> <li>The STANDBY lamp lights when power is turned off.</li> <li>Backlighting of the display is illuminated when power is turned on.</li> </ul>
<ul style="list-style-type: none"> <li>Batteries or car battery (DC12V)*</li> </ul>	<ul style="list-style-type: none"> <li>The STANDBY lamp does not light.</li> <li>Backlighting of the display is not illuminated.</li> <li>With the system turned off (at standby), no indication is shown on the display.</li> </ul>

\* If no source is playing and no operation is done for about 4 minutes, "DC OFF" starts flashing on the display for about one minute before the system turns off automatically (except when the source is FM/AM or AUX, or when the microphone/guitar is used).

## Turning on the system

**Press ON/STANDBY.**

- When the system is operated on batteries or car battery (DC12V), press ON/STANDBY on the system. The STANDBY lamp goes off when the system is operated on AC power. The display comes on and the system is ready to continue in the mode it was in when the power was last turned off.

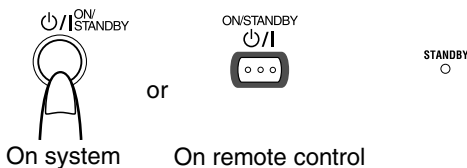

## Turning off the system

**Press ON/STANDBY again.**

The STANDBY lamp lights up when the system is operated on AC power.

- When the AC power is used, the CLOCK indicator and the time are displayed without backlighting.

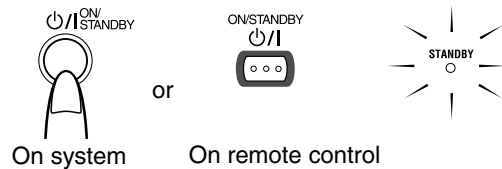

- Some power is always consumed even though power is turned off (called standby mode).
- To disconnect the system from mains (AC) supply completely, unplug the AC power cord from the AC outlet. When you unplug the AC power cord, the clock will be reset to "AM12:00" if no memory backup batteries are installed.

## Adjusting the volume

You can adjust the volume level between 0 and 50.

### Using the system

**Turn the VOLUME +/- control clockwise to increase the volume or turn it counterclockwise to decrease the volume.**

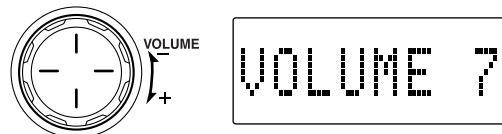

### Using the remote control

**Press VOLUME + to increase the volume or press VOLUME - to decrease it.**

When you press and hold VOLUME + or -, the volume changes rapidly.

### CAUTION:

**DO NOT start playing any source without setting the volume to minimum first, as a sudden blast of sound can damage your hearing, speakers and/or headphones.**

### For private listening

Connect a pair of headphones to the PHONES jack on the rear of the system (see page 5). No sound comes out of the speakers. Be sure to turn down the volume before connecting or putting on the headphones.

## Turning off the sound temporarily

### Using the remote control only

Press **MUTING**.

“MUTING” appears on the display.



On remote control

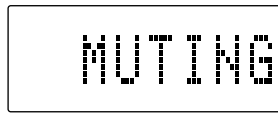

To restore the sound, press MUTING again or adjust the volume (see page 7).

## Adjusting the super woofer volume

During play, you can adjust the bass level between BASS 1 (minimum) and BASS 6 (maximum).

### Using the system

Turn the **SUPER WOOFER VOLUME +/- control clockwise to increase the bass level or turn it counterclockwise to decrease the bass level.**

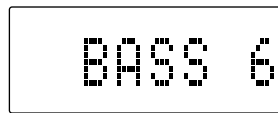
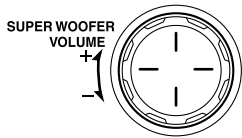

### Using the remote control

Press **SUPER WOOFER VOLUME +** to increase the bass level or press **SUPER WOOFER VOLUME -** to decrease it.

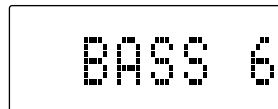
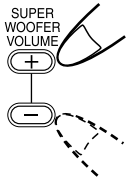

**Note:** This function is not effective when the headphones are in use.

## Activating clear sound

The Active Clear Sound (ACS) circuit emphasizes high-frequency sound without lowering the signal-noise ratio, while adjusting its output according to the input signal level. This results in a better balance between the high-frequency sound and the low-frequency heavy bass.

Press **ACS (active clear sound)** to turn it on or off.

When it is turned on, the ACS ON indicator lights in red.



On system

or



On remote control

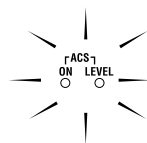

• The ACS LEVEL indicator flashes in green according to the input signal level.

## Selecting the sound mode

Sound modes can be selected to enhance the type of music being played.

Press **SOUND** to select the sound mode.

Each time you press the button, the sound mode changes as follows:

FLAT → BEAT → POP → CLEAR

SOUND



On system

or



On remote control

**Sound mode selection:**

**BEAT:**

Set to this position for music with a heavy beat, such as rock and disco music.

**POP:**

Set to this position for light music including popular and vocal music.

**CLEAR:**

Set to this position for crisp and clear sounding music with transparent highs.

**FLAT (no effect):** Set to this position not to apply any sound mode.

## Showing the time

While the power is turned on, you can see the current time (clock) at any time, as follows.

### Using the remote control only

Press **DISPLAY**.

Each time you press the button, the display changes as follows:

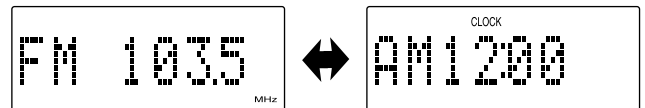

Current sound source (e.g. FM103.5 MHz) ↔ (clock)

**Note:** To let the clock work, you need to set the clock first. (See “Setting the clock” on page 15.)

# Listening to the radio

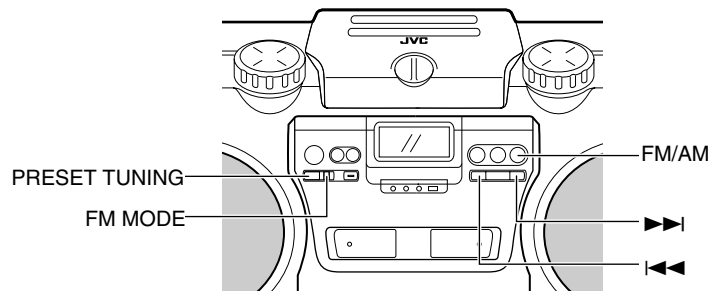
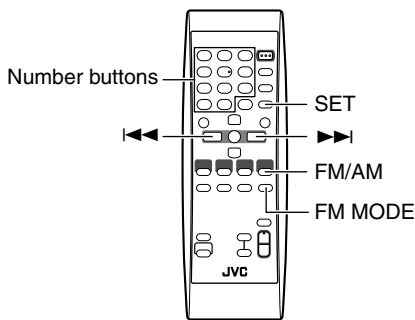

You can listen to FM and AM stations. Stations can be tuned in manually, automatically, or from preset memory storage.

- Before listening to the radio, fully extend the FM telescopic antenna.

## Tuning in to a station

### 1. Press FM/AM repeatedly to select either FM or AM.

Each time you press FM/AM, the band changes between FM and AM.

The system tunes in to the last tuned station. The following information appears on the display.

- When “Manual Tuning” or “Auto Tuning” was used to tune in to the last tuned station (see below), the band frequency appears.

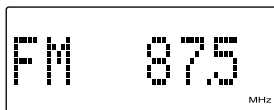

- When “Preset Tuning” was used to tune in to the last tuned station (see the right column), the preset number (displayed as “P-XX” on the display) and then the band frequency appear.

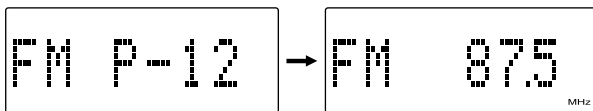

(After one second)

### 2. Select a station using one of the following methods.

- When you tune in to an FM stereo broadcast, the STEREO indicator lights up and you can hear stereo effect.  
**If an FM stereo broadcast is hard to receive or noisy**, press FM MODE. The MONO indicator lights up and the sound becomes monaural, but the reception improves. When you tune in to another station, the MONO indicator goes off and stereo effect restores automatically.

**Note: AM broadcasts are monaural.**

#### ■ Manual Tuning

Press ◀◀ or ▶▶ repeatedly to move from frequency to frequency until you find the station you want.

OR

#### ■ Auto Tuning

Press and hold ◀◀ or ▶▶ for one second or more.

The frequency changes automatically until a station frequency is found.

OR

#### ■ Preset Tuning (possible only after presetting stations)

Select the desired preset number using PRESET TUNING on the system or the number buttons on the remote control. The preset number and then the band frequency appear on the display.

**PRESET TUNING button:** Each time you press the button, the preset number increases.

**Number buttons:** To select P-5, press 5.  
 To select P-15, press +10 then 5.  
 To select P-20, press +10 once then press 10.

#### **Notice: To adjust the reception condition**

**For FM:** Adjust the FM telescopic antenna’s length, angle and direction until the best reception is obtained.

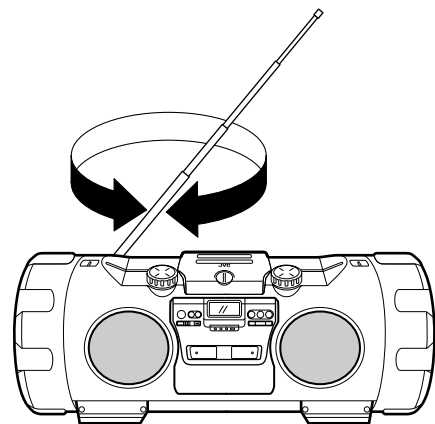

**For AM:** Change the direction of the system to obtain the best reception.

Placing the system near the window, for example, will improve AM reception.

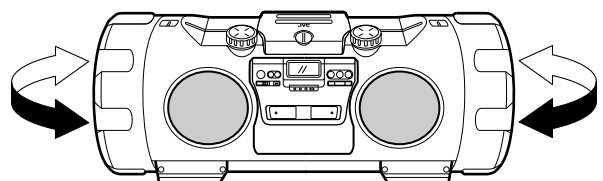

## Presetting stations

You can preset up to 30 FM stations and 15 AM stations.

**Note:** Preset numbers may have been set to factory test frequencies prior to shipment. This is not a malfunction. You can preset the stations you want into memory as follows:

### Using the remote control only

There is a time limit in doing the following steps. If the setting is canceled before you finish, start again from step 3.

**1. Press FM/AM repeatedly to select either FM or AM.**

**2. Press ◀◀ or ▶▶ to tune in to a station.**

**3. Press SET.**

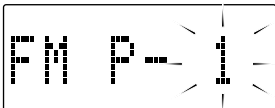

**4. Press the number buttons to select the preset number you want.**

- To select 5, press 5.
- To select 15, press +10 then 5.
- To select 20, press +10 once then press 10.

**5. Press SET.**

“STORED” appears on the display and the station is stored.

**6. Repeat above steps 1. to 5. for each station you want to store into memory with a preset number.**

To change the preset stations, repeat the same steps as above to overwrite a new station.

### CAUTION:

To prevent the preset stations from being erased because of a power failure, etc., install memory backup batteries in the system. (See pages 5 and 6.)

## Playing back discs

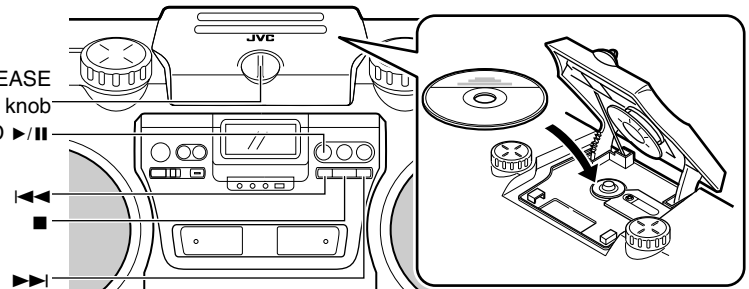
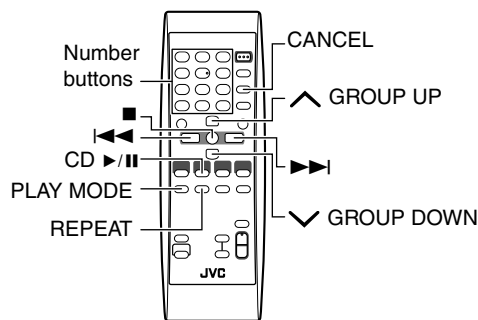

This system has been designed to play back the following discs—CD, finalized CD-R/CD-RW (recorded in audio CD format) and CD-R/CD-RW (in MP3 format).

- This system is not compatible with the other discs such as DVD, DVD-R, and DVD-RW.

### Notes on MP3:

- The system can only recognize files (tracks) with “MP3” or “mp3” as the extensions, which can be in any combination of upper and lower case.
- It is recommended that you record your material at a 44.1 kHz sampling rate, using the 128 kbps data transfer rate.
- You can play back the discs containing the tracks in music CD format or MP3 files in ISO 9660 format.
- Some MP3 tracks or discs may not be played back because of their characteristics or recording conditions.
- MP3 discs require a longer readout time than normal discs.

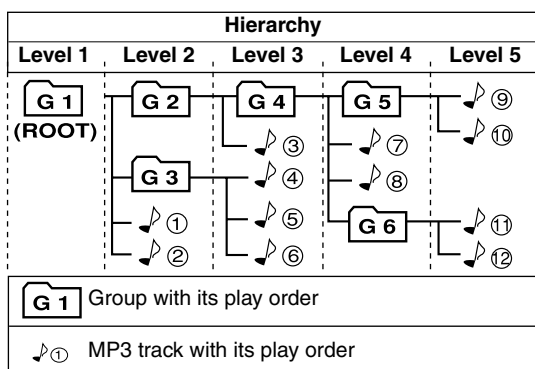

- This system recognizes up to 999 tracks on a disc (or less depending on the recording condition of a disc).

## Setting a disc

**1. Turn the LOCK/RELEASE knob counterclockwise to open the disc compartment door.**

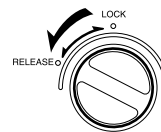

**2. Place a disc, with its label side up as shown above.**

**3. Close the disc compartment door and turn the knob to “LOCK” position.**

To remove the disc, open the disc compartment door in stop mode.

- You can place an 8 cm (3-3/16”) disc without an adapter.
- If the disc cannot be read correctly (because it is scratched, for example), “NO PLAY” or “NO DISC” appears on the display.
- You can place a disc while listening to the other source.

## Using the disc player—Normal Play

### To play a disc

#### 1. Set a disc.

#### 2. Press CD ►/II.

The first track of the disc starts playing.

##### For CDs:

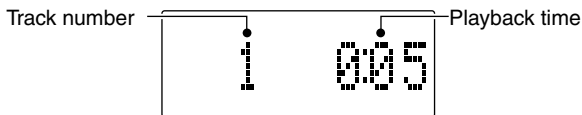

##### For MP3 discs:

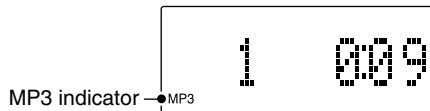

- When playing an MP3 disc, the file name (then ID3 Tag if any) is displayed at the beginning of each track.
- If no disc is inserted, “NO DISC” appears on the display and the system remains in stop mode.
- The system automatically stops when the last track of the disc has finished playing.

To stop playing the disc, press ■.

The following information for the disc is displayed.

##### For CDs:

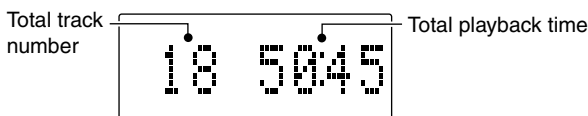

##### For MP3 discs:

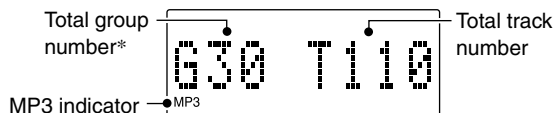

\* If a disc includes more than 99 groups, “G –” will appear on the display.

To pause, press CD ►/II. The playback time flashes on the display.

To cancel pause, press the same button again. Playback continues from the point where it was paused.

**Note:** Do not turn the LOCK/RELEASE knob during playback.

### Skip Play

Press ◀◀ or ▶▶ to select the track you want to play during playback.

- Press ▶▶ once to skip to the beginning of the next track.
- Press ◀◀ to skip to the beginning of the track being played. Press ◀◀ twice quickly to skip to the beginning of the previous track.

You can also select a track in stop mode with the same buttons.

**For CD:** Selected track and its playback time are shown on the display.

**For MP3:** Group and track numbers (then ID3 Tag if any) are shown on the display.

To start playback, press CD ►/II.

### Search Play

Press and hold ◀◀ or ▶▶ to fast forward/reverse the disc during playback.

You can quickly find a particular passage in the track you are listening to. During search play, you can hear the sound of approx. one forth level.

### To locate a track directly

Using the remote control only \_\_\_\_\_

Press the number buttons to directly play a track.

- To directly play track 5, press 5.
- To directly play track 15, press +10 then 5.
- To directly play track 20, press +10 once then press 10.

(Only for MP3 discs)

- To directly play track 109, press +100 once then press 9.
- To directly play track 125, press +100, +10, +10 then 5.

### To select a group (for MP3 disc)

Using the remote control only \_\_\_\_\_

Press ^ GROUP UP or v GROUP DOWN to select the group you want to play during playing the MP3 disc.

- Press ^ GROUP UP to skip to the next group.
- Press v GROUP DOWN to skip to the previous group.

You can also select a group in stop mode with the same buttons.

To play the group after selection, press CD ►/II.

## Programming the playing order of the tracks

### Using the remote control only

- You can program up to 50 tracks in any desired order including the same tracks.
- You can only make a program when the system is stopped.
- While making a program, you cannot specify a group number to select a track.

#### 1. Set a disc.

#### 2. Press CD ►/II.

#### 3. Press ■ to stop the disc.

#### 4. Press PLAY MODE repeatedly to select "PROGRAM."

The system enters the programming mode and the PRGM indicator lights up.

#### 5. Press the number buttons to select the track to program.

- For detailed operations, see "To locate a track directly" on page 11.

**Example:** For track 7, press 7.

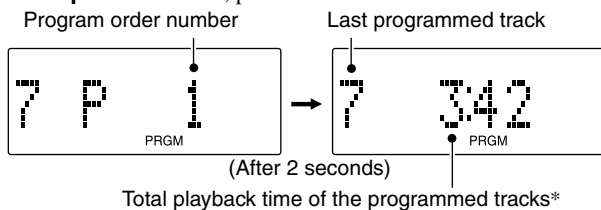

\*Total playback time will not appear while making a program using an MP3 disc.

#### 6. Repeat step 5. to select other tracks for the program.

- To cancel the last track programmed, press CANCEL once.

#### 7. Press CD ►/II.

The system plays the tracks in the same order as you have programmed them.

- You can skip to a particular programmed track by pressing ◀◀ or ▶▶ during program play.

#### While stopped:

- **To confirm the programmed tracks**, press ◀◀ or ▶▶ repeatedly; the tracks making up the program will successively be displayed in the programmed order.
  - To add a track to the end of the program, simply press the number buttons.
- **To delete the tracks in the program**, press CANCEL repeatedly. Each time you press the button, the last track will be erased.
- **To delete the entire program**, press and hold CANCEL until "CLEAR!" appears on the display.
  - Turning off the power will clear the program.
- **To exit from program mode**, press PLAY MODE repeatedly until the PRGM indicator goes off. Each time you press the button, the play mode changes as follows:  
Normal play → PROGRAM → RANDOM → (back to the beginning)

#### Note:

(For CDs) If the total playback time of the programmed tracks exceeds 99 minutes 59 seconds, "-- : --" will appear on the display.

## Random play

The tracks will play in no special order when you use this mode.

### Using the remote control only

#### 1. Set a disc.

#### 2. Press CD ►/II.

#### 3. Press ■ to stop the disc.

#### 4. Press PLAY MODE repeatedly to select "RANDOM."

The RANDOM indicator lights up on the display.

#### 5. Press CD ►/II.

The tracks are played in random order once.

**To skip a track during playback**, press ▶▶ to skip to another track in the random sequence. The ◀◀ button works only to go back to the beginning of the current track.

#### While stopped:

- **To exit from random mode**, press PLAY MODE repeatedly until the RANDOM indicator goes off. Each time you press the button, the play mode changes as follows:  
Normal play → PROGRAM → RANDOM → (back to the beginning)

## Repeating tracks

You can repeat the tracks or individual track as many times as you like.

### Using the remote control only

#### Press REPEAT.

Each time you press the button, repeat indicator changes as follows:

#### For CDs:

◀ ALL → ◀ → canceled → (back to the beginning)

- ◀ ALL: Repeats all the tracks on the disc.
- ◀ : Repeats the current track.

#### For MP3 discs:

◀ ALL → ◀ GROUP → ◀ → canceled → (back to the beginning)

- ◀ ALL: Repeats all the tracks on the disc.
- ◀ GROUP: In normal play mode, repeats all the tracks in a group.  
In program and random play modes, group repeat cannot be selected.
- ◀ : Repeats the current track.

- Repeat mode (except "◀ GROUP") remains in effect even when you change the play mode.

**To exit from repeat mode**, press REPEAT repeatedly until the repeat indicator on the display goes off.

# Listening to the iPod

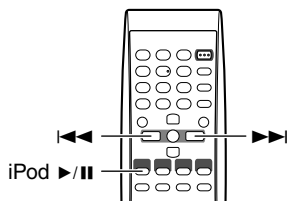

You can operate an iPod through the system.

- Before connecting your iPod to the system, check its type and software version (see page 4).
- Remember you cannot send any data to your iPod from the system.
- You can also operate the iPod directly even while it is connected to the system. For details of the operation, refer to the instructions of your iPod.

## CAUTIONS:

- The iPod battery is charged while the system is turned on. See the iPod instruction manual about charging times.
- Sound distortion may occur when playing back audio sources with high recording levels. Adjusting the iPod's equalizer to "Flat" is recommended. For information on operating the iPod, see the iPod instruction manual.
- JVC is not responsible for any loss of or damage to iPod that might result from the use of this product.
- When you connect your iPod to the cable, make sure it connects all the way in.
- Do not carry the system with iPod connected. You might drop it down or it might cause damages to the connector part.
- Do not touch or hit the iPod terminal pins or the connector pins directly. It might cause damages to the connector part.
- Remove the iPod from the cable when you do not use.

## Playing the iPod

### To play the iPod

#### 1. Set the volume level to minimum.

#### 2. Press iPod ▶/||.

The iPod is turned on and starts playing.

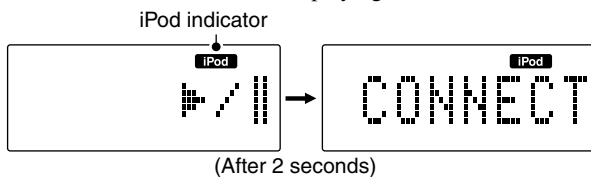

#### 3. Adjust the volume to the desired listening level.

To pause, press iPod ▶/||.

To cancel pause, press the same button again. Playback continues from the point where it was paused.

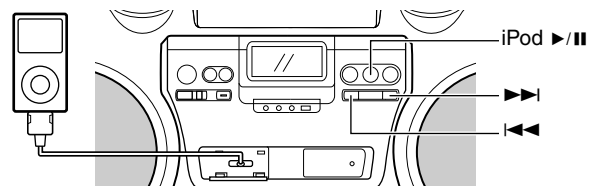

## Skip Play

Press ◀◀ or ▶▶ to select the track you want to play during playback.



- Press ▶▶ once to skip to the beginning of the next track.
- Press ◀◀ to skip to the beginning of the track being played. Press ◀◀ twice quickly to skip to the beginning of the previous track.

You can also select a track with the same buttons while the iPod is paused.

To start playback, press iPod ▶/||.

## Search Play

Press and hold ◀◀ or ▶▶ to fast forward/reverse the track during playback.



You can quickly find a particular passage in the track you are listening to. During search play, you can hear the sound of approx. one forth level.

## NOTE:

When iPod is selected as the source...

- "CONNECT" appears on the display with the iPod connected.
- "NO CONNECT" scrolls on the display without the iPod connected.

## Turning off the iPod

Press and hold iPod ▶/|| for about 2 seconds.

- Turning off the system\* or changing iPod to another source also turns off the iPod.

\*Turning off the system may not turn off the iPod depending on the current source.

## About the battery charge of the iPod

- When the system is operated on the AC power:  
The iPod battery is always charged except while FM/AM is selected as the source.
- When the system is operated on the batteries or the car battery (DC12V):  
The iPod battery is charged only while the system is turned on without FM/AM selected as the source.
  - The iPod battery will not be charged while "DC OFF" is flashing on the display (see page 6).



# Listening to auxiliary equipment

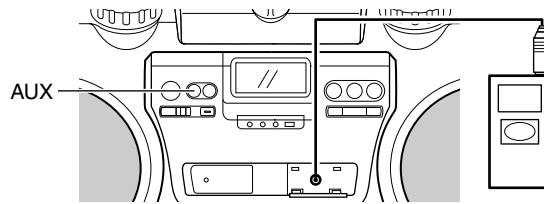
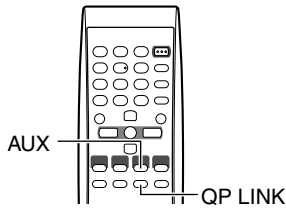

You can listen to auxiliary equipment.

First make sure that the auxiliary equipment is properly connected to the system. (See pages 5 and 6.)

**Note:** For operation of the auxiliary equipment, refer to its instructions.

## Listening to auxiliary equipment

### 1. Set the volume level to minimum.

### 2. Press AUX.

“AUX” appears on the display.

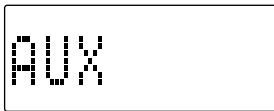

- To listen to the auxiliary equipment, start playing the auxiliary equipment.

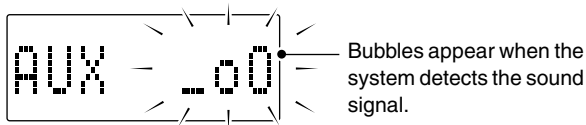

### 3. Adjust the volume to the desired listening level.

### 4. Apply sound effects, if you wish.

- Adjust the super woofer volume to reinforce the bass sound.

## Switching to AUX automatically—QP Link

Quick Portable Link (QP Link) automatically switches the source to AUX as the auxiliary equipment connected to the AUX jack starts playback.

### Using the remote control only

#### To activate QP Link

Press QP LINK repeatedly to show “QPL ON” on the display.

The QP LINK indicator appears on the display in the following cases to inform you that QP Link is ready to work:

- When an auxiliary equipment is connected to the AUX jack.
- When AUX is selected as the source.

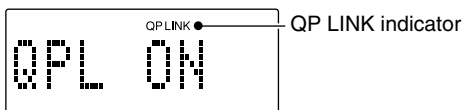

To cancel, press QP LINK repeatedly to show “QPL OFF” on the display.

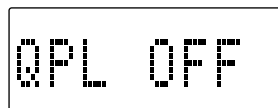

### How does QP Link work?

While QP Link is activated, starting playback performs the following:

- While listening to another source, Changes the source to AUX.
- When the power is supplied through the AC outlet and the system is turned off, Turns on the system and selects AUX as the source.

### NOTES:

- When the sound signal from the auxiliary equipment is too weak, QP Link may not function correctly. In this case, turn up the volume of the auxiliary equipment so that the system can detect the sound signal properly.
- If you change the source from AUX with QP Link turned on, QP Link will be deactivated temporarily. In this case, the following reactivate QP Link:
  - When the auxiliary equipment is unplugged from the AUX jack, then plugged in again.
  - When the sound signal from AUX jack stops or becomes very weak for about 30 seconds.
- If the system is turned off while QP Link is working, QP Link will be deactivated temporarily. In this case, QP Link is reactivated when the sound signal from AUX jack stops or becomes very weak for about 30 seconds after the system is turned off.
- While QP Link is activated, QP Link may start working when you just connect the auxiliary equipment to the AUX jack or unplug it. This is not a malfunction.

## Changing the AUX jack sensitivity

You can change the AUX jack sensitivity when QP Link mistakenly works with detecting non-playback signals from the auxiliary equipment, such as its switching noise.

### Using the remote control only

#### Press and hold QP LINK.

Each time you press and hold QP LINK, the sensitivity level changes between QPL LV1 and QPL LV2.

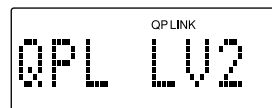

**QPL LV1:** Normally select this (initial setting).

**QPL LV2:** Select this when QP Link works mistakenly.

# Using the microphone/guitar

## Microphone/guitar mixing

Using a microphone or a guitar (not supplied), you can mix its sound with a source sound.

### 1. Make sure the MIC/GUITAR LEVEL control on the rear of the system is properly set.

- When using a microphone, make sure the knob is pressed in (■).
- When using a guitar, make sure the knob is released (□).

### 2. Set the MIC/GUITAR LEVEL control to MIN by turning it fully counterclockwise.

### 3. Connect a microphone or a guitar into the MIC/GUITAR INPUT jack on the rear of the system.

### 4. Start a source: disc, tuner, iPod, or auxiliary equipment.

### 5. Adjust the VOLUME +/- control and the MIC/GUITAR LEVEL control, as you play the microphone or the guitar.

#### CAUTION:

**DO NOT** connect a bass guitar to the MIC/GUITAR INPUT jack, as it may damage the system.

# Using the timer

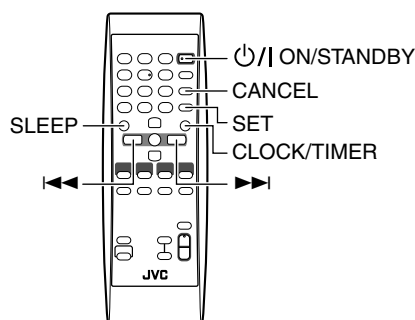

The timers let you control the listening functions automatically.

## Setting the clock

When the power is first supplied, the CLOCK indicator and “AM12:00” flash on the display. Set the clock.

#### Note:

The clock must be correctly set for the timers to work.

### Using the remote control only

#### 1. Press **ON/STANDBY**.

#### 2. Press **CLOCK/TIMER** repeatedly until the **CLOCK** indicator lights up.

The hour digit flashes on the display.

#### 3. Press **▶▶** or **◀◀** to select the hour.

- When you press and hold the button, the hour digit changes continuously.

#### 4. Press **SET** to set the hour.

The minutes digits start flashing on the display.

#### 5. Press **▶▶** or **◀◀** to select the minute.

- When you press and hold the button, the minute digit changes continuously.
- If you want to change the hour setting, press CANCEL.

#### 6. Press **SET** to finish setting the clock.

#### CAUTION:

**If memory backup batteries are exhausted or not installed, and the AC power cord is plugged in again after being disconnected, or power is restored after a power failure, the CLOCK indicator will flash on the display. Set the current time (clock) again.**

## Setting the sleep timer

Use the sleep timer to turn the system off after a certain number of minutes when it is playing. By setting the sleep timer, you can fall asleep to the music and know that your system will turn off by itself rather than playing all night.

- You can set the sleep timer only when the system is turned on.

### Using the remote control only

#### 1. Press **SLEEP**.

The SLEEP indicator lights up on the display.



## 2. Set the length of time you want the source to play before shutting off.

Each time you press the button, it changes the number of minutes shown on the display in this sequence:

10 → 20 → 30 → 60 → 90 → 120 → OFF → (back to the beginning)

After setting the number of minutes for the sleep timer, the indication will stop flashing and go off.

The system is now set to turn off after the number of minutes you set.

### To confirm the sleep time:

When SLEEP is pressed, the remaining sleep time is displayed. Wait until the display returns to the original display.

### To cancel the sleep timer:

Press SLEEP repeatedly to select "OFF." Turning off the system also cancels the sleep timer.

## Setting the daily timer

Once the timer has been set, it will be activated at the same time everyday until the timer is turned off.

- While the timer is being set, the timer indicator (⌚) lights up.
- After the timer has been set, the timer indicator (⌚) also lights up if the power is supplied through the AC outlet.
- While the timer is working, the timer indicator (⌚) flashes.

## Using the remote control only

### 1. Press ⏻/I ON/STANDBY.

### 2. Press CLOCK/TIMER.

"TIMERON?" appears.

- Press SET to activate the timer setting you have made before.
- Press CANCEL to cancel the timer.
- Go to the next step to set the timer first time (or reset the timer).

### 3. Press CLOCK/TIMER again, so that the timer indicator (⌚) and ON indicator light up.

The hour digit of the current ON time flashes on the display.

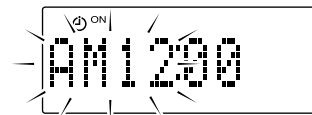

### 4. Set the on-time you want the system to turn on.

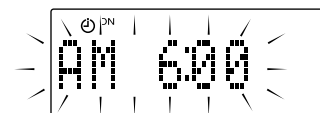

- (1) Press ►► or ◄◄ to select the hour, then press SET.
- (2) Press ►► or ◄◄ to select the minute, then press SET.  
The OFF indicator lights up.
  - Press and hold the button to change the time rapidly.
  - If you want to change the time setting, press CANCEL.

### 5. Set the OFF time (example: PM1:30).

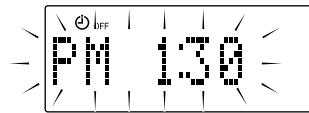

- (1) Press ►► or ◄◄ to select the hour, then press SET.
- (2) Press ►► or ◄◄ to select the minute, then press SET.
  - Press and hold the button to change the time rapidly.
  - If you want to change the time setting, press CANCEL.

### 6. Press ►► or ◄◄ to select the music source you want to listen to, then press SET.

Each time you press the button, the display changes as shown below:

TUNER → CD → iPod → (back to the beginning)

### 7. Press ►► or ◄◄ to select the volume level, then press SET.

--: The current volume level will be used.

0 to 50: When the timer is turned on, the volume will be automatically set to the selected level.

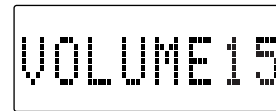

- The current timer setting appears for confirmation.

### 8. Before turning off the system, prepare the music source selected in step 6.

**TUNER:** Tune in to the desired frequency (FM/AM).

**CD:** Set a disc.

**iPod:** Connect an iPod to the iPod jack.

### 9. Press ⏻/I ON/STANDBY to turn off the system.

- When the timer turns on, the volume level gradually increases from 0 (zero) to the preset level in step 7.

However, if the volume has been set to "--", the volume level will be set to the last level directly.

**To cancel the operation,** press CLOCK/TIMER until the display returns to the original one.

**To cancel the timer,** press CLOCK/TIMER once, then press CANCEL. ("TIMEROFF" appears, only when power is on.)

**To reactivate (or confirm) the canceled timer,** press CLOCK/TIMER once, then press SET. (The current timer setting appears for confirmation.)

#### Notes:

- The timer cannot be set if on-time and off-time are the same.
- The timer does not work if the system is not in the standby mode (the system needs to be in standby mode at least one minute before the on-time).

#### CAUTION:

**If memory backup batteries are exhausted or not installed, and the AC power cord is disconnected or there is a power failure, time settings will be erased from memory. If this happens, set the current time (clock) and perform the timer setting again.**

# Care and maintenance

Handle your discs carefully, and they will last a long time.

## Compact discs



- This system can play back the following discs:
  - Audio CD
  - Finalized CD-R/CD-RW recorded in audio CD format or MP3 format

However, continued use of irregular shape discs (heart-shape, octagonal, etc.) can damage the system.

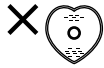

- Remove the disc from its case by holding it at the edges while pressing the case's center hole lightly.
- Do not touch the shiny surface of the disc, or bend the disc.
- Put the disc back in its case after use to prevent warping.
- Be careful not to scratch the surface of the disc when placing it back in the case.
- Avoid exposure to direct sunlight, temperature extremes, and moisture.
- A dirty disc may not play correctly. If a disc does become dirty, wipe it with a soft cloth in a straight line from center to edge.



### CAUTION:

**Do not use any solvent (for example, conventional record cleaner, spray thinner, benzene, etc.) to clean a disc.**

## General notes

In general, you will have the best performance by keeping your discs and the mechanism clean.

- Store discs in their cases, and keep them in cabinets or on shelves.
- Keep the disc compartment door closed when not in use.

## Cleaning the lens

If the lens in the pickup is dirty, dropout, etc., could degrade sound. Open the disc compartment door and clean the lens as shown.

- Use a blower (available at camera stores) to blow dust off the lens.

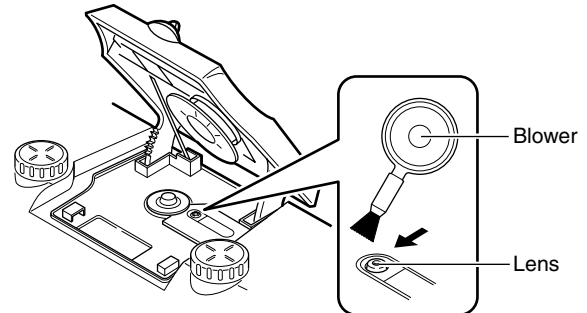

- If there are fingerprints, etc. on the lens, gently wipe clean with a cotton swab.

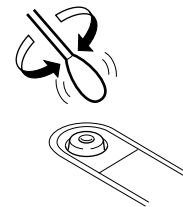

## Moisture condensation



Moisture may condense on the lens inside the system in the following cases:

- After turning on heating in the room.
- In a damp room.
- If the system is brought directly from a cold to a warm place.

Should this occur, the system may malfunction. In this case, leave the system turned on for a few hours until the moisture evaporates, unplug the AC power cord, and then plug it in again.

# Troubleshooting

- If you are having a problem with your system, check this list for a possible solution before calling for service.
- If you cannot solve the problem from the hints given here, or the system has been physically damaged, call a qualified person, such as your dealer, for service.

Symptom	Possible cause	Action
• Power does not come on.	• The power cord is not connected to an AC outlet.	• Insert the plug into the socket.
• No sound is heard.	• Connections are incorrect, or loose. • Headphones are connected. • MP3 disc is recorded with "packet writing."	• Check all connections and make corrections. (See pages 5 and 6.) • Disconnect the headphones. • It cannot be played. Replace the disc.
• Poor FM reception.	• The FM telescopic antenna is not properly extended and positioned.	• Fully extend the FM telescopic antenna and turn it for the best reception.

Symptom	Possible cause	Action
<ul style="list-style-type: none"> <li>The track skips.</li> <li>The disc does not play ("NO PLAY" or "NO DISC" appears).</li> <li>Specific files (tracks) on an MP3 disc are not played.</li> <li>iPod is not turned on.</li> <li>iPod does not play though "CONNECT" appears on the display.</li> <li>iPod is not charged.</li> </ul>	<ul style="list-style-type: none"> <li>The disc is dirty or scratched.</li> <li>The disc is upside down.</li> <li>The disc is dirty or scratched.</li> <li>Files other than MP3 are included in the disc.</li> <li>Connection is not firmly made.</li> <li>The battery of the iPod is empty.</li> <li>FM/AM is selected as the source.</li> <li>The system is in a standby mode when the system is operated on the batteries or the car battery (DC12V).</li> </ul>	<ul style="list-style-type: none"> <li>Clean or replace the disc.</li> <li>Put the disc in with the label side up.</li> <li>Change the disc.</li> <li>They cannot be played.</li> <li>Check the connection. (See page 6.)</li> <li>Leave the iPod connected for more than approximately ten minutes.</li> <li>Select any source other than FM/AM.</li> <li>Turn on the system.</li> </ul>
<ul style="list-style-type: none"> <li>Unable to operate the remote control.</li> </ul>	<ul style="list-style-type: none"> <li>The path between the remote control and the sensor on the system is blocked.</li> <li>The batteries have lost their charge.</li> </ul>	<ul style="list-style-type: none"> <li>Remove the obstruction.</li> </ul>
<ul style="list-style-type: none"> <li>Operations are disabled.</li> </ul>	<ul style="list-style-type: none"> <li>The built-in microprocessor has malfunctioned due to external electrical interference.</li> </ul>	<ul style="list-style-type: none"> <li>Replace the batteries.</li> <li>Unplug the system then plug it back in after a few minutes.</li> </ul>
<ul style="list-style-type: none"> <li>Indicators and the display do not light up while in standby mode.</li> </ul>	<ul style="list-style-type: none"> <li>Batteries or DC power is used to supply the power.</li> </ul>	

## Specifications

### Amplifier

Output Power

**6 W per channel, min. RMS, at 4 Ω from 150 Hz to 15 kHz with no more than 10% total harmonic distortion.**  
**20 W per channel woofer, min. RMS into 4 Ω at 60 Hz with no more than 10% total harmonic distortion.**

Input Sensitivity/Impedance (1 kHz)

AUX 300 mV/47 kΩ

MIC/GUITAR INPUT: Switchable

MIC 200 Ω – 2 kΩ (6.3 mm dia. plug)

GUITAR 100 kΩ – 1 MΩ (6.3 mm dia. plug)

Output Sensitivity/Impedance (1 kHz)

Phones 16 Ω – 1 kΩ

0 – 12 mW/ch output into 32 Ω

### Disc Player

Dynamic range 90 dB

Signal-to-noise ratio 95 dB

Wow and Flutter Unmeasurable

### Tuner

FM Tuner

Tuning Range

87.5 MHz – 108.0 MHz

AM Tuner

Tuning Range

530 kHz – 1 710 kHz

Antenna

FM telescopic antenna

Ferrite core antenna for AM

### Speakers

Full range

8 cm (3-3/16") × 2, 4 Ω

Super woofer

16 cm (6-5/16") × 2, 4 Ω

### General

Dimensions

690 mm × 239 mm × 293 mm (W/H/D)  
(27-3/16" × 9-7/16" × 11-9/16")

Mass

9.2 kg (20.3 lbs) (without batteries)

10.3 kg (22.8 lbs) (with batteries)

### Power Specifications

Power Requirements

AC 120 V ~ , 60 Hz

DC 15 V ("R20/D(13F)" batteries [10])

External DC 12 V (car battery via optional CA-R120 car adapter)

Power Supply to iPod

5 V/500 mA

Power Consumption

AC 120 V ~ , 60 Hz 50 W (power on mode)

1.3 W (in standby mode)

External DC 12 V

2.5 A (power on mode)

Design and specifications are subject to change without notice.

For U.S.A.

## ***TO OUR VALUED CUSTOMER*** ———

THANK YOU FOR PURCHASING THIS JVC PRODUCT.  
WE WANT TO HELP YOU ACHIEVE A PERFECT EXPERIENCE.

**NEED HELP ON HOW TO HOOK UP?  
NEED ASSISTANCE ON HOW TO OPERATE?  
NEED TO LOCATE A JVC SERVICE CENTER?  
LIKE TO PURCHASE ACCESSORIES?**

**JVC<sup>®</sup> IS HERE TO HELP!**  
**TOLL FREE: 1(800)252-5722**  
**<http://www.jvc.com>**

Remember to retain your Bill of Sale for Warranty Service.

————— **Do not attempt to service the product yourself** —————

**Caution**

To prevent electrical shock, do not open the cabinet.  
There are no user serviceable parts inside.  
Please refer to qualified service personnel for repairs.

---

For U.S.A.

\*\*\*\*\*



**LIMITED WARRANTY**

1-1 **USA ONLY**

**ONLY FOR PRODUCT PURCHASED IN U.S.A.**

JVC Americas Corp. (JVC) warrants this product and all parts thereof, except as set forth below ONLY TO THE ORIGINAL RETAIL PURCHASER to be FREE FROM DEFECTIVE MATERIALS AND WORKMANSHIP from the date of original purchase for the period shown below. ("The Warranty Period")

PARTS	<b>1 YR</b>	LABOR	<b>1 YR</b>
-------	-------------	-------	-------------

**THIS LIMITED WARRANTY IS VALID ONLY IN THE FIFTY (50) UNITED STATES, THE DISTRICT OF COLUMBIA AND IN THE COMMONWEALTH OF PUERTO RICO.**

**WHAT WE WILL DO:**

If this product is found to be defective within the warranty period, JVC will repair or replace defective parts with new or rebuilt equivalents at no charge to the original owner. Such repair and replacement services shall be rendered by JVC during normal business hours at JVC authorized service centers. Parts used for replacement are warranted only for the remainder of the Warranty Period. All products may be brought to a JVC authorized service center on a carry-in basis. Color televisions with a screen size of 27" or greater qualify for in-home service. In such cases, a technician will come to your home and either repair the TV there or remove and return it if it cannot be repaired in your home.

**WHAT YOU MUST DO FOR WARRANTY SERVICE:**

*Please do not return your product to the retailer*

**Instead, return your product to the JVC authorized service center nearest you. If shipping the product to the service center, please be sure to package it carefully, preferably in the original packaging, and include a brief description of the problem(s). Please call 1-800-252-5722 to locate the nearest JVC authorized service center. Service locations can also be obtained from our website <http://www.jvc.com>. If your product qualifies for in-home service, the service representative will require clear access to the product.**

If you have any questions concerning your JVC Product, please contact our Customer Care Center at 800-252-5722

**WHAT IS NOT COVERED:**

This limited warranty provided by JVC does not cover:

1. Products which have been subject to abuse, accident, alteration, modification, tampering, negligence, misuse, faulty installation, lack of reasonable care, or if repaired or serviced by anyone other than a service facility authorized by JVC to render such service, or if affixed to any attachment not provided with the products, or if the model or serial number has been altered, tampered with, defaced or removed;
2. Initial installation, installation and removal from cabinets or mounting systems.
3. Operational adjustments covered in the Owner's Manual, normal maintenance, video and audio head cleaning;
4. Damage that occurs in shipment, due to act of God, and cosmetic damage;
5. Signal reception problems and failures due to line power surge;
6. User Removal Memory Devices/Video Pick-up Tubes/CCD Image Sensors are covered for 90 days from the date of purchase;
7. Accessories;
8. Batteries (except that Rechargeable Batteries are covered for 90 days from the date of purchase);
9. Products used for commercial purposes, including, but not limited to rental.
10. Loss of data resultant from malfunction of hard drive or other data storage device;

There are no express warranties except as listed above.

THE DURATION OF ANY IMPLIED WARRANTIES, INCLUDING THE IMPLIED WARRANTY OF MERCHANTABILITY, IS LIMITED TO THE DURATION OF THE EXPRESS WARRANTY HEREIN.

JVC SHALL NOT BE LIABLE FOR ANY LOSS OF USE OF THE PRODUCT, INCONVIENCE, OR ANY OTHER DAMAGES, WHETHER DIRECT, INCIDENTAL OR CONSEQUENTIAL (INCLUDING, WITHOUT LIMITATION, DAMAGE TO TAPES, RECORDS OR DISCS) RESULTING FROM THE USE OF THIS PRODUCT, OR ARISING OUT OF ANY BREACH OF THIS WARRANTY. ALL EXPRESS AND IMPLIED WARRANTIES, INCLUDING THE WARRANTIES OF MERCHANTABILITY AND FITNESS FOR PARTICULAR PURPOSE, ARE LIMITED TO THE WARRANTY PERIOD SET FORTH ABOVE.

Some states do not allow the exclusion of incidental or consequential damages or limitations on how long an implied warranty lasts, so these limitations or exclusions may not apply to you. This warranty gives you specific legal rights and you may also have other rights which vary from state to state.

**JVC AMERICAS CORP.**  
1700 Valley Road, Wayne, New Jersey 07470  
<http://www.jvc.com>

\*\*\*\*\*

REFURBISHED PRODUCTS CARRY A SEPARATE WARRANTY, THIS WARRANTY DOES NOT APPLY. FOR DETAIL OF REFURBISHED PRODUCT WARRANTY, PLEASE REFER TO THE REFURBISHED PRODUCT WARRANTY INFORMATION PACKAGED WITH EACH REFURBISHED PRODUCT.

**For customer use:**

Enter below the Model No. and Serial No. which is located either on the rear, bottom or side of the cabinet. Retain this information for future reference.

Model No. : \_\_\_\_\_ Serial No. : \_\_\_\_\_

Purchase date : \_\_\_\_\_ Name of dealer : \_\_\_\_\_

RV-NB20B/RV-NB20W

POWERED WOOFER CD SYSTEM

**JVC**