

JVC

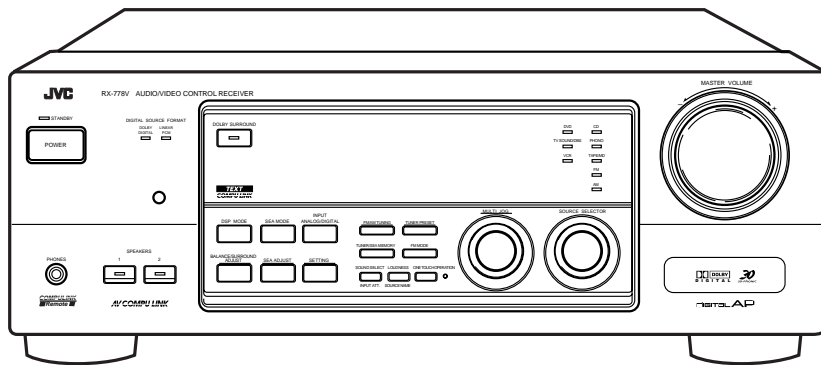

AUDIO/VIDEO CONTROL RECEIVER

RX-778VBK

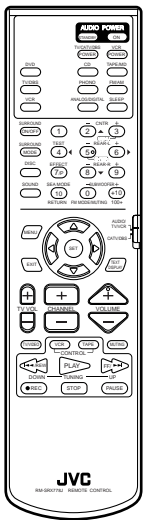

DIGITAL AP

AV COMPU LINK

**TEXT
COMPU LINK**

**COMPU LINK
Remote**

**3D
3D-PHONIC**

**DOLBY
DIGITAL**

INSTRUCTIONS

For Customer Use:

Enter below the Model No. and Serial No. which are located either on the rear, bottom or side of the cabinet. Retain this information for future reference.



Model No. _____

Serial No. _____

LVT0171-001A

[J]

Warnings, Cautions and Others

| | | |
|---|---|---|
|  | CAUTION RISK OF ELECTRIC SHOCK DO NOT OPEN |  |
| CAUTION: TO REDUCE THE RISK OF ELECTRIC SHOCK, DO NOT REMOVE COVER (OR BACK) NO USER SERVICEABLE PARTS INSIDE. REFER SERVICING TO QUALIFIED SERVICE PERSONNEL. | | |

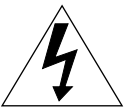

The lightning flash with arrowhead symbol, within an equilateral triangle is intended to alert the user to the presence of uninsulated "dangerous voltage" within the product's enclosure that may be of sufficient magnitude to constitute a risk of electric shock to persons.



The exclamation point within an equilateral triangle is intended to alert the user to the presence of important operating and maintenance (servicing) instructions in the literature accompanying the appliance.

WARNING: TO REDUCE THE RISK OF FIRE OR ELECTRIC SHOCK, DO NOT EXPOSE THIS APPLIANCE TO RAIN OR MOISTURE.

Caution — POWER switch!
Disconnect the mains plug to shut the power off completely. The POWER switch in any position does not disconnect the mains line. The power can be remote controlled.

For U.S.A.
This equipment has been tested and found to comply with the limits for a Class B digital device, pursuant to part 15 of the FCC Rules. These limits are designed to provide reasonable protection against harmful interference in a residential installation. This equipment generates, uses and can radiate radio frequency energy and, if not installed and used in accordance with the instructions, may cause harmful interference to radio communications. However, there is no guarantee that interference will not occur in a particular installation. If this equipment does cause harmful interference to radio or television reception, which can be determined by turning the equipment off and on, the user is encouraged to try to correct the interference by one or more of the following measures:
Reorient or relocate the receiving antenna.
Increase the separation between the equipment and receiver.
Connect the equipment into an outlet on a circuit different from that to which the receiver is connected.
Consult the dealer or an experienced radio/TV technician for help.

CAUTION

To reduce the risk of electrical shocks, fire, etc.:

1. Do not remove screws, covers or cabinet.
2. Do not expose this appliance to rain or moisture.

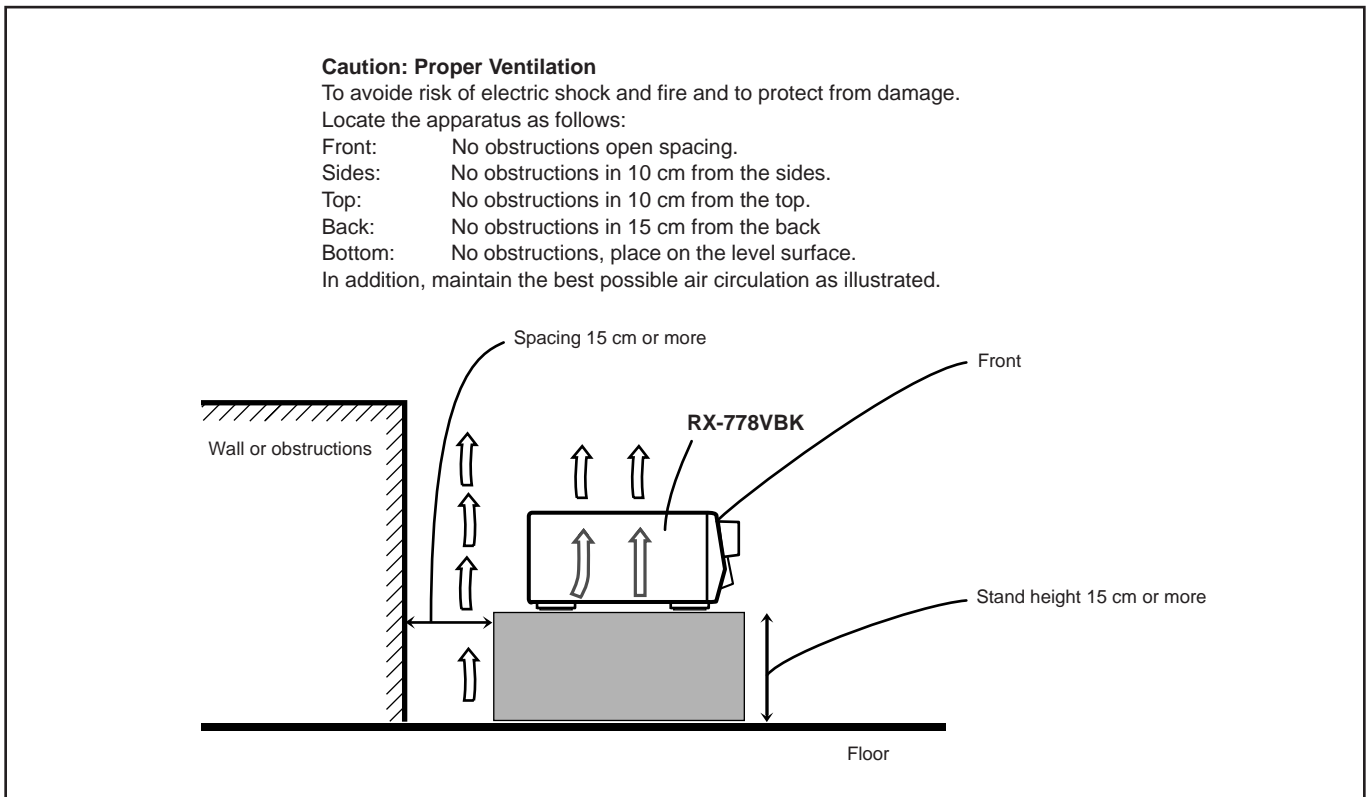

| | | | |
|--|-----------|---|-----------|
| Parts Identification | 2 | Using the DSP Modes | 20 |
| Getting Started | 3 | Available DSP Modes According to the Speaker Arrangement .. | 22 |
| Before Installation | 3 | Adjusting the 3D-PHONIC Modes | 23 |
| Checking the Supplied Accessories | 3 | Adjusting the DAP Modes | 23 |
| Connecting the FM and AM Antennas | 3 | Adjusting the Surround Modes | 24 |
| Connecting the Speakers | 4 | Activating the DSP Modes | 27 |
| Connecting Audio/Video Components | 6 | Using the On-Screen Menus | 28 |
| Connecting the Power Cord | 8 | Selecting the Source to Play | 28 |
| Putting Batteries in the Remote Control | 8 | Selecting the Different Source for Picture and Sound | 28 |
| Basic Operations | 9 | Activating the DSP Modes | 28 |
| Turning the Power On and Off (Standby) | 9 | Adjusting the Front Speaker Output Balance | 28 |
| Selecting the Source to Play | 9 | Listening at Low Volume (Loudness) | 29 |
| Adjusting the Volume | 10 | Attenuating the Input Signal | 29 |
| Selecting the Front Speakers | 10 | Adjusting the Subwoofer Output Level | 29 |
| Muting the Sound | 11 | Adjusting the DSP Modes | 29 |
| Listening at Low Volume (Loudness) | 11 | Selecting Your Favorite SEA Mode | 30 |
| Attenuating the Input Signal | 11 | Creating Your Own SEA Mode | 30 |
| Adjusting the Subwoofer Output Level | 11 | Setting the Basic Setting Items | 31 |
| Basic Settings | 12 | Operating the Tuner | 31 |
| Adjusting the Front Speaker Output Balance | 12 | Storing the Preset Stations | 32 |
| Changing the Source Name | 12 | Assigning Names to Preset Stations | 32 |
| Setting the Subwoofer Information | 12 | COMPU LINK Remote Control System | 33 |
| Digital Input (DIGITAL IN) Terminal Setting | 12 | TEXT COMPU LINK Remote Control System .. | 34 |
| Selecting the Analog or Digital Input Mode | 13 | Showing the Disc Information on the TV Screen | 35 |
| Showing the Text Information on the Display | 13 | Searching for a Disc (Only for the CD player) | 36 |
| Setting the Speakers for the DSP Modes | 14 | Entering the Disc Information | 37 |
| Storing the Basic Settings and Adjustments — One Touch | | AV COMPU LINK Remote Control System | 39 |
| Operation | 16 | Operating JVC's Audio/Video Components ... | 41 |
| Using the Sleep Timer | 16 | Operating Other Manufacturers' Video | |
| Recording a Source | 16 | Equipment | 43 |
| Receiving Radio Broadcasts | 17 | Troubleshooting | 45 |
| Tuning in Stations Manually | 17 | Specifications | 46 |
| Using Preset Tuning | 17 | | |
| Selecting the FM Reception Mode | 18 | | |
| Assigning Names to Preset Stations | 18 | | |
| Using the SEA Modes | 19 | | |
| Selecting Your Favorite SEA Mode | 19 | | |
| Creating Your Own SEA Mode | 19 | | |

Parts Identification

Become familiar with the buttons and controls on the receiver before use.
Refer to the pages in parentheses for details.

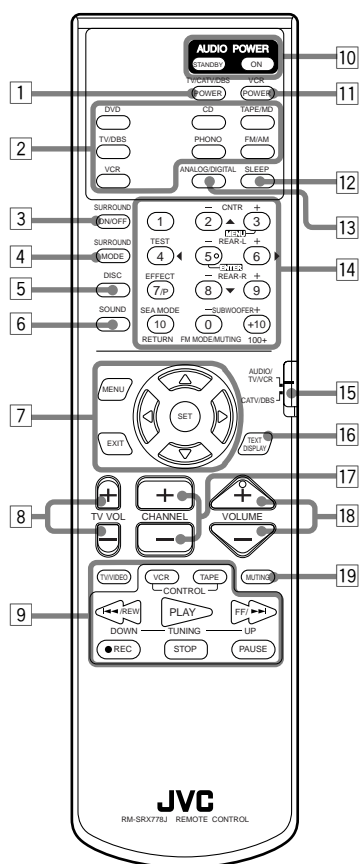
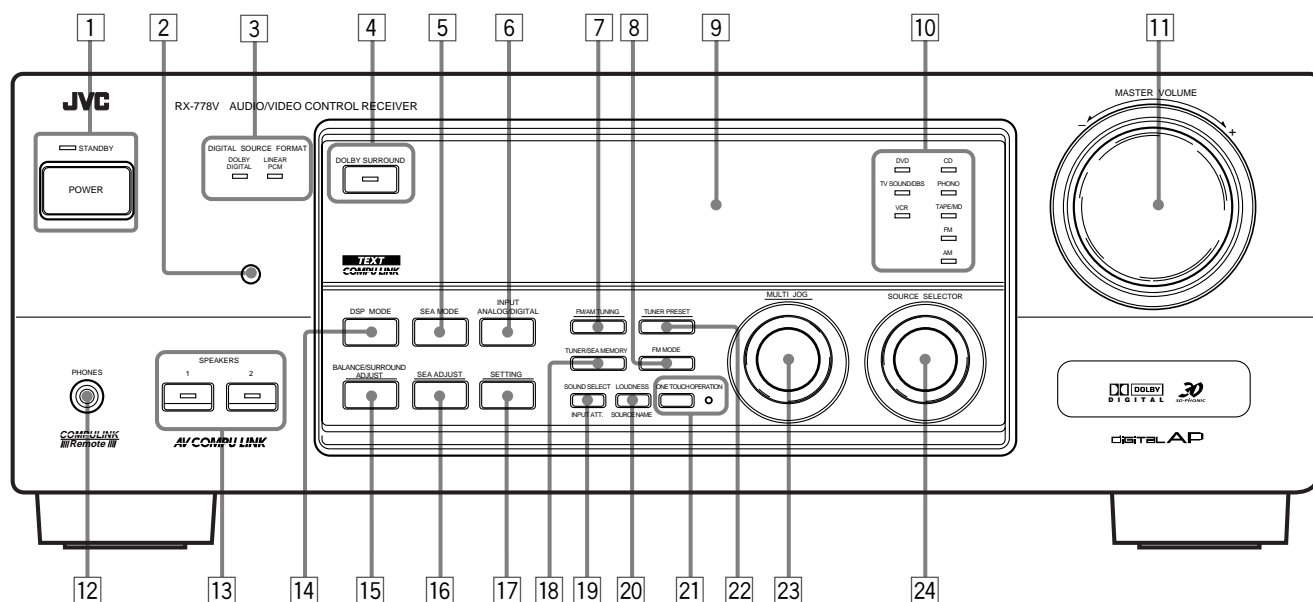

Front Panel

- 1 POWER button and STANDBY lamp (9)
 - 2 Remote sensor (8)
 - 3 DIGITAL SOURCE FORMAT lamps (10)
DOLBY DIGITAL, LINEAR PCM
 - 4 DOLBY SURROUND button and lamp (27)
 - 5 SEA MODE button (19)
 - 6 INPUT ANALOG/DIGITAL button (13)
 - 7 FM/AM TUNING button (17)*
 - 8 FM MODE button (18)
 - 9 Display (9)
 - 10 Source lamps (9)
 - 11 MASTER VOLUME control (10)
 - 12 PHONES jack (11)
 - 13 SPEAKERS 1/2 buttons and lamps (10)
 - 14 DSP MODE button (23)
 - 15 BALANCE/SURROUND ADJUST button
(11, 12, 23)*
 - 16 SEA ADJUST button (19)*
 - 17 SETTING button (12 – 15)*
 - 18 TUNER/SEA MEMORY button (17 – 19)
 - 19 SOUND SELECT/INPUT ATT. button
(10, 11)
 - 20 LOUDNESS/SOURCE NAME button
(11, 12)
 - 21 ONE TOUCH OPERATION button and lamp
(16)
 - 22 TUNER PRESET button (18)*
 - 23 MULTI JOG control
- What this control actually does depends on which function you are trying to adjust. Before using this control, select the function by pressing one of the buttons marked with *.
- 24 SOURCE SELECTOR control (9)

Remote Control

- 1 TV/CATV/DBS POWER button (42 – 44)
- 2 Source selecting buttons (9)
DVD, CD, TAPE/MD, TV/DBS, PHONO,
FM/AM, VCR
- 3 SURROUND ON/OFF button (27)
- 4 SURROUND MODE button (23)
- 5 DISC button (41)
- 6 SOUND button (19, 23)
- 7 On-screen operation buttons (28, 35)
MENU, SET, EXIT, Δ, ▽, ◀, ▶
- 8 TV VOL +/- buttons (42, 43)
- 9 Operating buttons for audio/video components
(42 – 44)
- 10 AUDIO POWER buttons (9)
STANDBY, ON
- 11 VCR POWER button (42 – 44)
- 12 SLEEP button (16)
- 13 ANALOG/DIGITAL button (13)
- 14
 - 10 keys for selecting preset channel (18)
 - 10 keys for adjusting sound (23 – 26)
 - 10 keys for operating audio/video components (41 – 44)
- 15 Remote control mode selector (9, 41, 43)
- 16 TEXT DISPLAY button (35)
- 17 CHANNEL +/- button (42 – 44)
- 18 VOLUME +/- button (10)
- 19 MUTING button (11)

Getting Started

This section explains how to connect audio/video components and speakers to the receiver, and how to connect the power supply.

Before Installation

General

- Be sure your hands are dry.
- Turn the power off to all components.
- Read the manuals supplied with the components you are going to connect.

Locations

- Install the receiver in a location that is level and protected from moisture.
- The temperature around the receiver must be between -5° and 35° C (23° and 95° F).
- Make sure there is good ventilation around the receiver. Poor ventilation could cause overheating and damage the receiver.

Handling the receiver

- Do not insert any metal object into the receiver.
- Do not disassemble the receiver or remove screws, covers, or cabinet.
- Do not expose the receiver to rain or moisture.

Checking the Supplied Accessories

Check to be sure you have all of the following items, which are supplied with the receiver.

The number in the parentheses indicates quantity of the pieces supplied.

- Remote Control (1)
- Batteries (2)
- AM Loop Antenna (1)
- FM Antenna (1)

If anything is missing, contact your dealer immediately.

Connecting the FM and AM Antennas

FM Antenna Connections

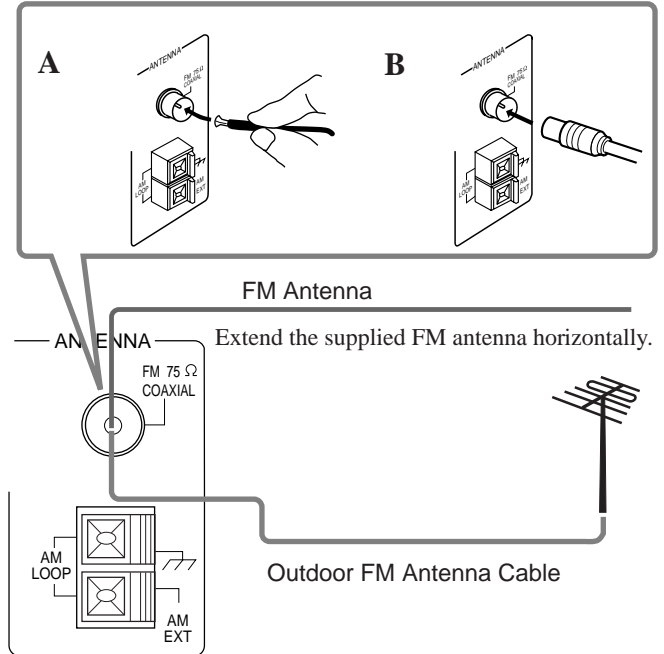

A. Using the Supplied FM Antenna

The FM antenna provided can be connected to the FM 75 OHM COAXIAL terminal as temporary measure.

B. Using the Standard Type Connector (Not Supplied)

A standard type connector should be connected to the FM 75 OHM COAXIAL terminal.

Note:

If reception is poor, connect the outdoor antenna. Before attaching a 75 OHM coaxial cable (the kind with a round wire going to an outdoor antenna), disconnect the supplied FM antenna.

AM Antenna Connections

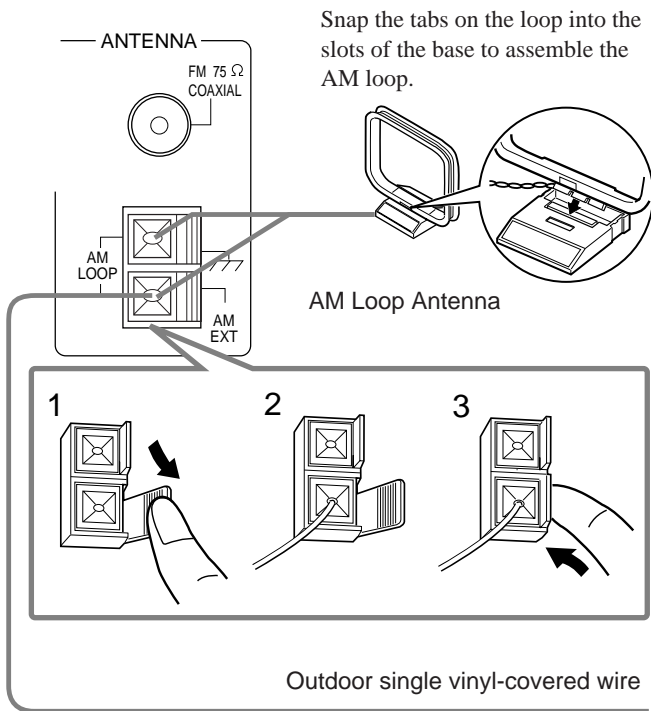

Turn the loop until you have the best reception.

Notes:

- Make sure the antenna conductors do not touch any other terminals, connecting cords and power cord. This could cause poor reception.
- If reception is poor, connect an outdoor single vinyl-covered wire to the AM EXT terminal. (Keep the AM loop antenna connected.)

Connecting the Speakers

You can connect the following speakers:

- Two pairs of front speakers to produce normal stereo sound.
- One pair of rear speakers to enjoy the surround effect.
- One center speaker to produce more effective surround effect (to emphasize human voices).
- One subwoofer to enhance the bass.

IMPORTANT:

After connecting the speakers listed above, set the speaker setting information properly to obtain the best possible DSP effect. For details, see page 14.

For each speaker (except for a subwoofer), connect the (-) and (+) terminals on the rear panel to the (-) and (+) terminals marked on the speakers. For connecting a subwoofer, see page 5.

CAUTION:

Use speakers with the SPEAKER IMPEDANCE indicated by the speaker terminals.

Basic connecting procedure

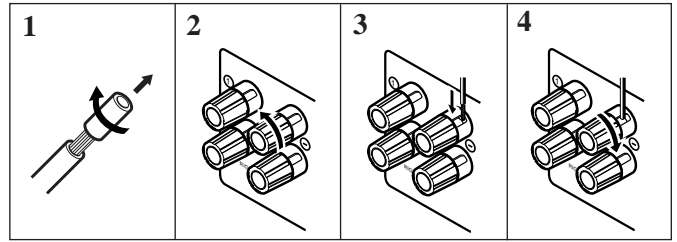

- 1 Cut, twist and remove the insulation at the end of each speaker signal cable (not supplied).
- 2 Turn the knob counterclockwise.
- 3 Insert the speaker signal cable.
- 4 Turn the knob clockwise.

Connecting the front speakers

You can connect two pairs of front speakers (one pair to the FRONT SPEAKERS ① terminals, and another pair to the FRONT SPEAKERS ② terminals).

Right speaker — FRONT SPEAKERS ① — Left speaker

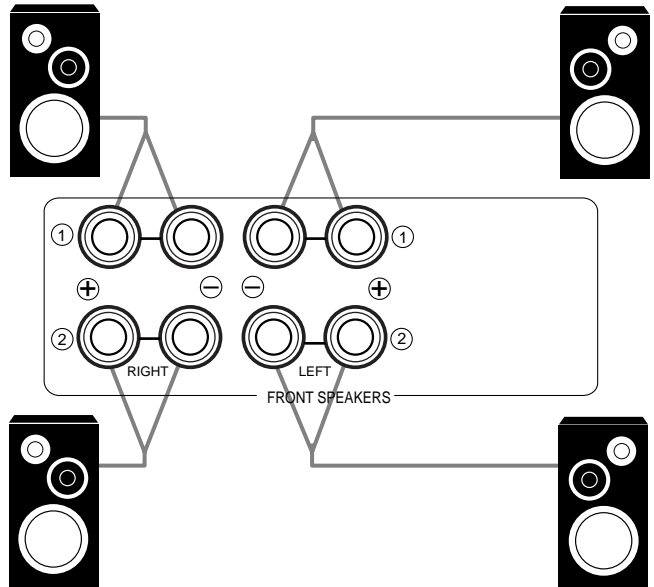

Right speaker — FRONT SPEAKERS ② — Left speaker

About the speaker impedance

The required speaker impedance of the front speakers does differ depending on whether both the FRONT SPEAKERS ① and FRONT SPEAKERS ② terminals are used or only one of them is used.

CASE 1 When you connect only one set of front speakers

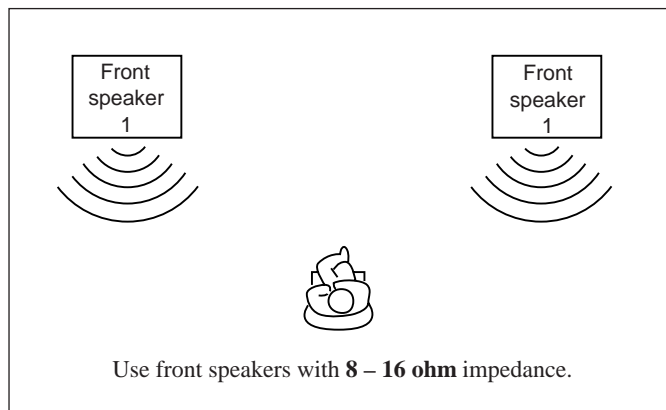

CASE 2 When you connect two sets of front speakers

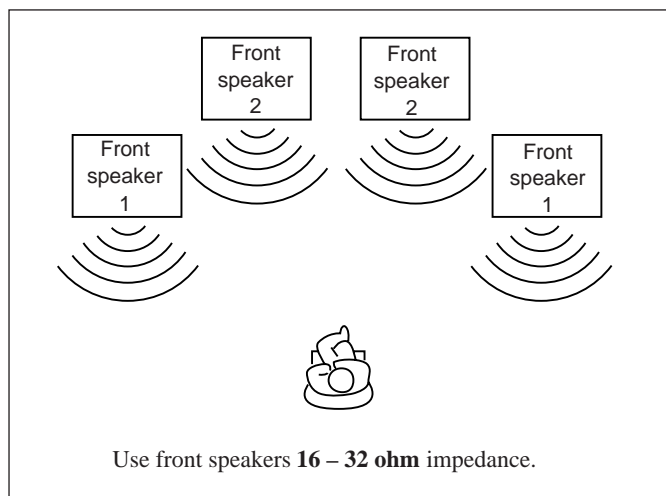

CAUTION:

Use speakers with the SPEAKER IMPEDANCE indicated by the speaker terminals.

Connecting the rear and center speakers

Connect rear speakers to the REAR SPEAKERS terminals and a center speaker to the CENTER SPEAKER terminals.

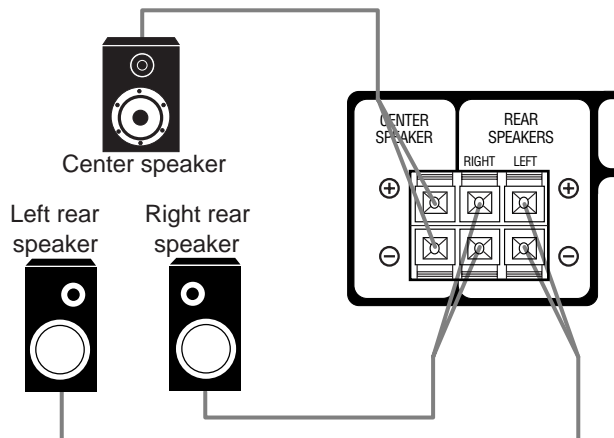

Connecting the subwoofer speaker

You can enhance the bass by connecting a subwoofer. Connect the input jack of a powered subwoofer to the SUBWOOFER OUT jack on the rear panel, using a cable with RCA pin plugs (not supplied).



Connecting Audio/Video Components

You can connect the following audio/video components to this receiver. Refer also to the manuals supplied with your components.

| Audio Components | Video Components |
|------------------------------------|------------------|
| • Turntable | • DVD player* |
| • CD player* | • TV |
| • Cassette deck or MD recorder* | • DBS tuner* |
| | • VCR |

* You can connect these components using the methods described in "Analog connections" (below) or in "Digital connections" (see page 8).

Analog connections

Audio component connections

Use the cables with RCA pin plugs (not supplied). Connect the white plug to the audio left jack, and the red plug to the audio right jack.

CAUTION:

If you connect a sound-enhancing device such as a graphic equalizer between the source components and this receiver, the sound output through this receiver may be distorted.

Turntable

If an earth cable is provided for your turntable, connect the cable to the screw marked (⚡) on the rear panel.

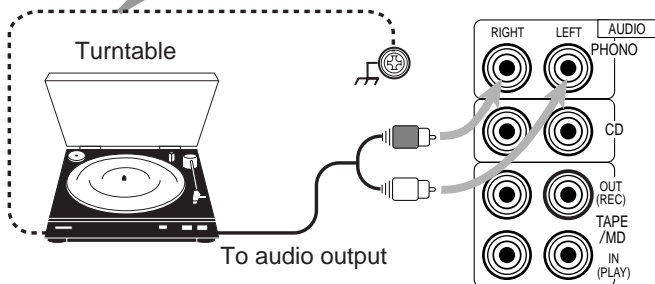

Note:

Any turntables incorporating a small-output cartridge such as an MC (moving-coil type) must be connected to this receiver through a commercial head amplifier or step-up transformer. Direct connection may result in insufficient volume.

CD player

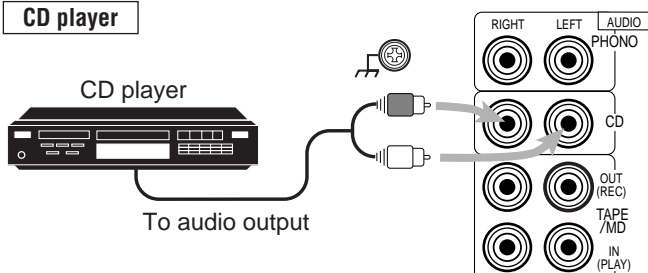

Cassette deck or MD recorder

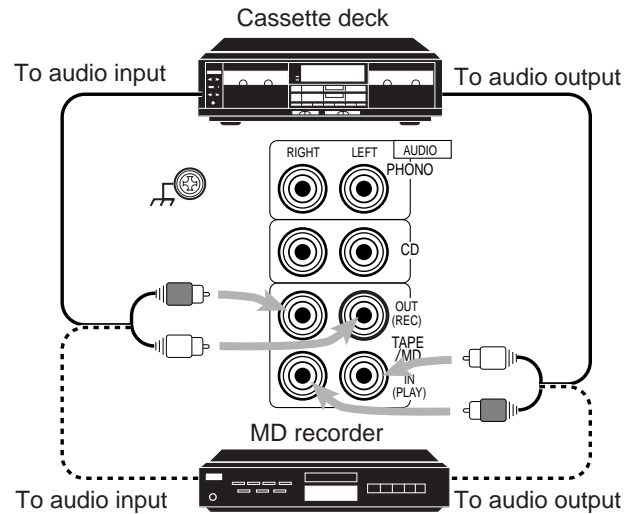

Note:

You can connect either a cassette deck or an MD recorder to the TAPE/MD jacks. When connecting an MD recorder to the TAPE/MD jacks, change the source name, which will be shown on the display when selected as the source, to "MD." See page 12 for details.

If your audio components have a COMPU LINK-3 or TEXT COMPU LINK terminal

- See also page 33 for detailed information about the connection and the COMPU LINK-3 remote control system.
- See also page 34 for detailed information about the connection and the TEXT COMPU LINK remote control system.

Video component connections

Use the cables with RCA pin plugs (not supplied).

Connect the white plug to the audio left jack, the red plug to the audio right jack, and the yellow plug to the video jack.

If DVD player and TV have S-video (Y/C-separation) terminals, connect them using S-video cables (not supplied). Connecting these video components through the S-video input/output terminals will give you better picture playback quality.

IMPORTANT:

This receiver is equipped with both the composite video and S-video input terminals for the DVD player connection. You do not have to connect both the composite video and S-video terminals. However, **remember that the video signals from the composite video input terminal are output only through the composite video output terminals, while the ones from the S-video input terminal are output only through the S-video output terminal.**

Therefore, if your DVD player is connected to the receiver only through the S-video input terminal, you cannot record the picture from the DVD player on the VCR.

In addition, if the TV and the DVD player are connected to the receiver through the different video terminals, you cannot view the playback picture from the DVD player on the TV.

VCR

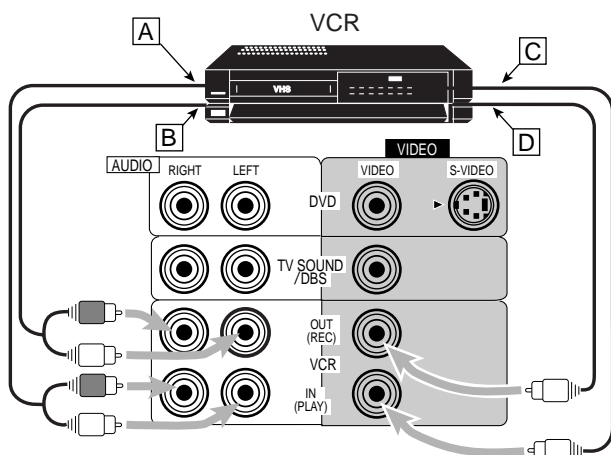

- A To left/right channel audio output
- B To left/right channel audio input
- C To video output
- D To video input

DVD player

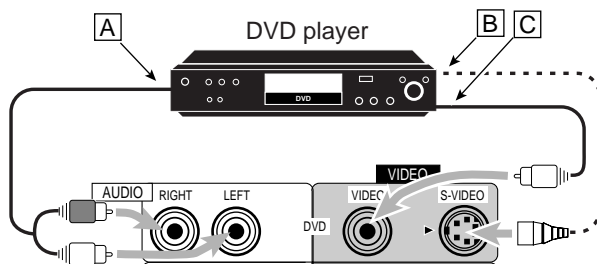

- A To front left/right channel audio output (or to audio mixed output if necessary)
- B To S-video output
- C To composite video output

TV and/or DBS tuner

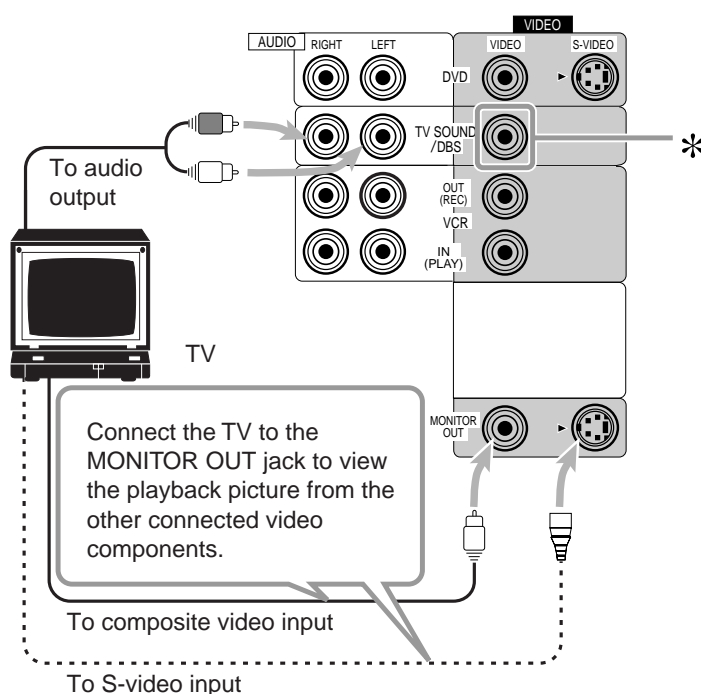

Note:

* When connecting the TV to the TV SOUND/DBS jacks, DO NOT connect the TV's video output to the VIDEO jacks.

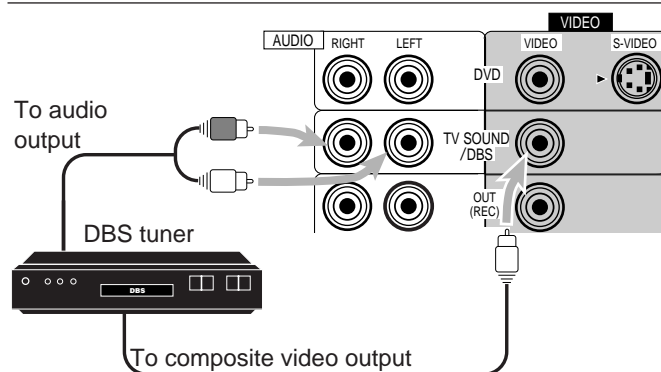

Note:

When connecting the DBS tuner to the TV SOUND/DBS jacks, change the source name, which will be shown on the display when selected as the source, to "DBS." See page 12 for details.

Digital connections

This receiver is equipped with two digital input terminals. You can connect any component to the digital terminals using digital optical cables (not supplied).

IMPORTANT:

- When connecting the DVD player or the DBS tuner using the digital terminal, you also need to connect it to the video jack on the rear. Without connecting it to the video jack, you can view no playback picture.
- After connecting the components using the DIGITAL IN terminals, set the following correctly if necessary.
 - Select the digital input mode correctly. For details, see “Selecting the Analog or Digital Input Mode” on page 13.
 - Set the digital input (DIGITAL IN) terminal setting correctly. For details, see “Digital Input (DIGITAL IN) Terminal Setting” on page 13.

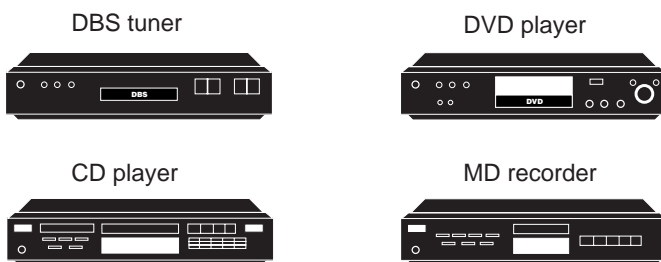

When the component has a digital optical output terminal, connect it to the DIGITAL 1 (DVD) or DIGITAL 2 (CD) terminal, using the digital optical cable (not supplied).

Before connecting a digital optical cable, unplug the protective plug.

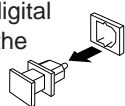

Notes:

- When shipped from the factory, the DIGITAL IN terminals have been set for use with the following components.
 - DIGITAL 1: For DVD player
 - DIGITAL 2: For CD player
- When you want to operate the CD player or MD recorder using the COMPU LINK remote control system, connect the target component also as described in “Analog connections” (see page 6).
- When you want to operate the DVD player using the AV COMPU LINK remote control system, connect the DVD player also as described in “Analog connections” (see page 7).

Connecting the Power Cord

Before plugging the receiver into an AC outlet, make sure that all connections have been made.

Plug the power cord into an AC outlet.

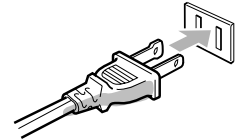

Keep the power cord away from the connecting cables and the antenna. The power cord may cause noise or screen interference. We recommend that you use a coaxial cable to connect the antenna, since it is well-shielded against interference.

Note:

The preset settings such as preset channel and sound adjustment may be erased in a few days in the following cases:

- When you unplug the power cord.
- When a power failure occurs.

CAUTION:

- Do not touch the power cord with wet hands.
- Do not pull on the power cord to unplug the cord. When unplugging the cord, always grasp the plug so as not to damage the cord.

Putting Batteries in the Remote Control

Before using the remote control, put two supplied batteries first. When using the remote control, aim the remote control directly at the remote sensor on the receiver.

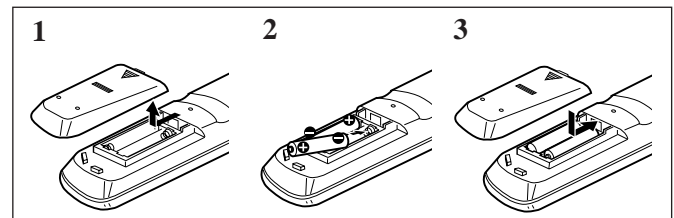

1. On the back of the remote control, remove the battery cover.
2. Insert batteries. Make sure to match the polarity: (+) to (+).
3. Replace the cover.

If the range or effectiveness of the remote control decreases, replace the batteries. Use two R6P(SUM-3)/AA(15F) type dry-cell batteries.

CAUTION:

Follow these precautions to avoid leaking or cracking cells:

- Place batteries in the remote control so they match the polarity: (+) to (+).
- Use the correct type of batteries. Batteries that look similar may differ in voltage.
- Always replace both batteries at the same time.
- Do not expose batteries to heat or flame.

Basic Operations

The following operations are commonly used when you play any sound source.

IMPORTANT:

When using the remote control, check to see if its remote control mode selector is set to the correct position:

To operate an audio system, TV, and VCR, set it to "AUDIO/TV/VCR."

To operate a CATV converter and DBS tuner, set it to "CATV/DBS."

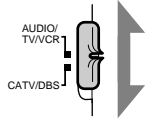

From the remote control:

Press one of the source selecting buttons.

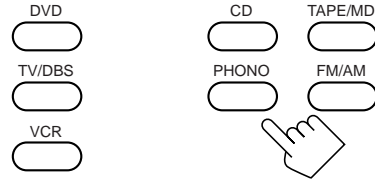

Turning the Power On and Off (Standby)

On the front panel:

To turn on the power, press POWER.

The STANDBY lamp goes off. The name of the current source (or station frequency) appears on the display.

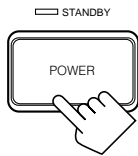

Current source name appears

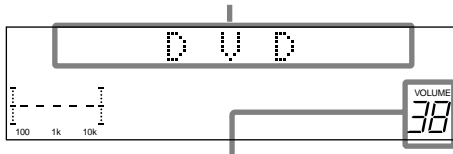

Current volume level is shown here

To turn off the power (into standby mode), press POWER again.

The STANDBY lamp lights up. A small amount of power is consumed in standby mode. To turn the power off completely, unplug the AC power cord.

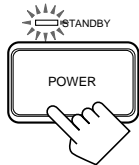

From the remote control:

To turn on the power, press AUDIO POWER POWER ON.

The STANDBY lamp goes off. The name of the current source (or station frequency) appears on the display.

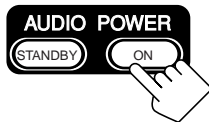

To turn off the power (into standby mode), press AUDIO POWER STANDBY.

The STANDBY lamp lights up.



Selecting the Source to Play

On the front panel:

Turn SOURCE SELECTOR until the source name you want appears on the display.

As you turn the selector, the source changes as follows:

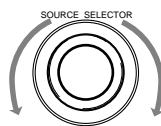

CD ⇄ PHONO ⇄ TAPE (or MD) ⇄ FM ⇄
AM ⇄ DVD ⇄ TV SOUND (or DBS) ⇄
VCR ⇄ (back to the beginning)

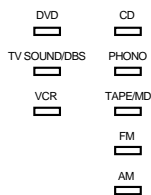

The selected source lamp also lights up.

Selected source name appears

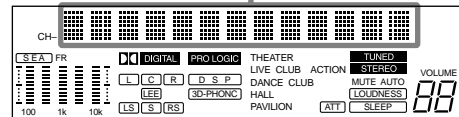

DVD

Select the DVD player.

CD *

Select the CD player.

TAPE/MD *

Select the cassette deck (or the MD recorder).

TV/DBS

- Select TV sounds when the remote control mode selector is set to "AUDIO/TV/VCR."

- Select the DBS tuner when the remote control mode selector is set to "CATV/DBS."

PHONO *

Select the turntable.

FM/AM *

Select an FM or AM broadcast.

- Each time you press the button, the band alternates between FM and AM.

VCR

Select the video component connected to the VCR jacks.

Notes:

- When connecting an MD recorder (to the TAPE/MD jacks), and a DBS tuner (to the TV SOUND/DBS jacks), change the source name shown on the display. For details, see page 12.
- When you press one of the source selecting buttons on the remote control marked above with an asterisk (*), the receiver automatically turns on.

When playing a digital source through a digital terminal

- The DIGITAL SOURCE FORMAT lamps on the front panel indicate what type of the digital signal comes into the receiver.

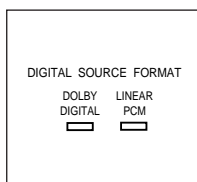

DOLBY DIGITAL:
Lights up when Dolby Digital signals (see page 21) come in.

LINEAR PCM:
Lights up when Linear PCM signals come in.

- The signal indicators also light up on the display to indicate the incoming channel signals. (Only the indicators for the incoming signals light up.)

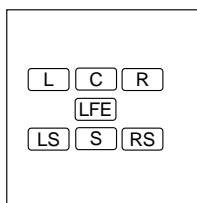

L: Left front channel
R: Right front channel
C: Center channel
LS: Left rear channel
RS: Right rear channel
S: Rear channel (monaural)
LFE: Subwoofer channel

Selecting different sources for picture and sound

You can watch picture from a video component while listening to sound from another component.

On the front panel:

1. Press **SOUND SELECT (INPUT ATT.)** briefly while viewing the picture from a video component such as the VCR or DVD player, etc.

“SOUND SELECT” appears on the display.

2. Turn **SOURCE SELECTOR** to select the sound (except the TV sound), while the indication of the above step is still on the display.

SOUND SELECT

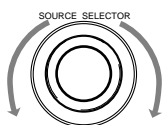

From the remote control:

Press one of the audio source selecting buttons (CD, TAPE/MD, PHONO, FM/AM), while viewing the picture from a video component such as the VCR or DVD player, etc.

Notes:

- Once you have selected a video source, pictures of the selected source are sent to the TV until you select another video source.
- When you select “TV SOUND” as the source, this function does not work.

Adjusting the Volume

On the front panel:

To increase the volume, turn MASTER VOLUME clockwise.

To decrease the volume, turn it counterclockwise.

- When you turn MASTER VOLUME rapidly, the volume level also changes rapidly.
- When you turn MASTER VOLUME slowly, the volume level also changes slowly.

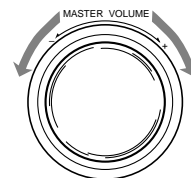

From the remote control:

To increase the volume, press VOLUME +.

To decrease the volume, press VOLUME -.



CAUTION:

Always set the volume to the minimum before starting any source. If the volume is set at its high level, the sudden blast of sound energy can permanently damage your hearing and/or ruin your speakers.

Note:

The volume level can be adjusted within the range of “0” (minimum) to “90” (maximum).

Selecting the Front Speakers

On the front panel ONLY:

When you have connected two pairs of the front speakers, you can select which to use.

Press **SPEAKERS 1** or **SPEAKERS 2** to select the speaker to use.

- Each time you press the button, the lamp on the respective button turns on and off. When the lamp on either button lights up, the respective speakers are activated.

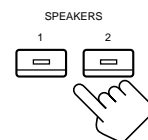

Note:

If you use any of the DSP modes other than the 3D-PHONIC modes with both front speakers activated, the speakers connected to the FRONT SPEAKERS ② terminals are deactivated.

Listening only with headphones

1. Connect a pair of headphones to the PHONES jack on the front panel.
2. Press SPEAKERS 1 and/or 2 so that no lamps on the buttons are turned on.

CAUTION:

Be sure to turn down the volume before connecting or putting on headphones, as high volume can damage both the headphones and your hearing.

Muting the Sound

From the remote control ONLY:

Press **MUTING** to mute the sound through all speakers and headphones connected.

“MUTING” appears on the display and the volume turns off (the volume level indicator goes off).



To restore the sound, press **MUTING** again so that “OFF” appears on the display.

- Turning **MASTER VOLUME** on the front panel or pressing **VOLUME +/-** on the remote control also restores the sound.

Listening at Low Volume (Loudness)

Human ears are not sensitive to bass at low volume. To compensate for this, the loudness function automatically boosts the bass level as you lower the volume.

On the front panel ONLY:

Press **LOUDNESS (SOURCE NAME)** briefly to select the loudness function.

- Each time you press the button, the loudness function turns on (“LOUDNESS ON”) and off (“LOUDNESS OFF”).
 - Select “LOUDNESS ON” to activate the loudness function. The **LOUDNESS** indicator lights up on the display.
 - Select “LOUDNESS OFF” to cancel it. The indicator goes off.



Note:

The loudness function affects the front speaker sounds only.

Attenuating the Input Signal

When the input level of the playing source is too high, the sounds will be distorted. If this happens, you need to attenuate the input signal level to prevent the sound distortion.

On the front panel ONLY:

Press and hold **INPUT ATT. (SOUND SELECT)** so that the **ATT** indicator lights up on the display.

- Each time you press and hold the button, the Input Attenuator mode turns on (“INPUT ATT ON”) or off (“INPUT NORMAL”).

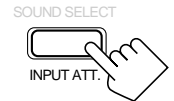

Notes:

- This function is available only for the sources connected using the analog terminals.
- This function takes effect when the DSP mode is in use.

Adjusting the Subwoofer Output Level

You can adjust the subwoofer output level if you have selected “YES” for the “SUBWOOFER” (see page 12).

Once it has been adjusted, the receiver memorizes the adjustment.

Before you start, remember...

- There is a time limit in doing the following steps. If the setting is canceled before you finish, start from step 1 again.

On the front panel:

1. Press **BALANCE/SURROUND ADJUST** repeatedly until “SUBWFR LEVEL” appears on the display.

The display changes to show the current setting.

2. Turn **MULTI JOG** to adjust the subwoofer output level (–10 dB to +10 dB).

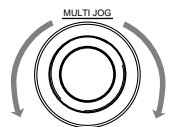

From the remote control:

1. Press **SOUND**.

The 10 keys are activated for sound adjustments.

2. Press **SUBWOOFER +/-** to adjust the subwoofer output level (–10 dB to +10 dB).

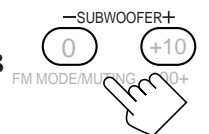
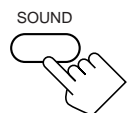

Basic Settings

Some of the following settings are required after connecting and positioning your speakers in your listening room, while others will make operations easier.

IMPORTANT:

When using the remote control, check to see if its remote control mode selector is set to the correct position:

To operate this receiver, set it to "AUDIO/TV/VCR" (except when selecting the DBS tuner as the source).

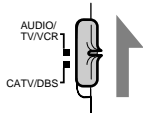

To change the source name to "TAPE" or "TV SOUND," repeat the same procedure above — in step 1, select "MD" or "DBS" then press and hold SOURCE NAME (LOUDNESS).

Note:

Without changing the source name, you can still use the connected components. However, there may be some inconvenience.

- "TAPE" or "TV SOUND" will appear on the display when you select the MD recorder or DBS tuner.
- You cannot use the digital input (see page 13) for the MD recorder and the DBS tuner.
- You cannot use the COMPU LINK remote control system (see page 33) to operate the MD recorder.

Adjusting the Front Speaker Output Balance

If the sounds you hear from the front right and left speakers are unequal, you can adjust the speaker output balance.

Before you start, remember...

- There is a time limit in doing the following steps. If the setting is canceled before you finish, start from step 1 again.

On the front panel ONLY:

1. Press **BALANCE/SURROUND ADJUST** repeatedly until "L/R BALANCE" appears on the display.



The display changes to show the current setting.

2. Turn **MULTI JOG** to adjust the balance.

- Turning it clockwise decreases the left channel output.
- Turning it counterclockwise decreases the right channel output.

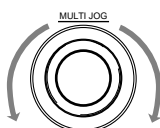

Setting the Subwoofer Information

Register whether or not you have connected a subwoofer.

Before you start, remember...

- There is a time limit in doing the following steps. If the setting is canceled before you finish, start from step 1 again.

On the front panel:

1. Press **SETTING** repeatedly until "SUBWOOFER" appears on the display.

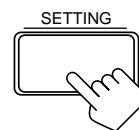

The display changes to show the current setting.

2. Turn **MULTI JOG** to register whether you have connected a subwoofer or not.

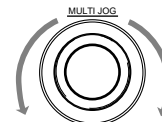

- As you turn it, the subwoofer setting alternates between "YES" or "NO."

Changing the Source Name

When you have connected an MD recorder to the TAPE/MD jacks or the DBS tuner to the TV SOUND/DBS jacks on the rear panel, change the source name shown on the display when you select the MD recorder or DBS tuner as the source.

On the front panel ONLY:

1. When changing the source name from "TAPE" to "MD":

- Turn **SOURCE SELECTOR** until "TAPE" appears.

When changing the source name from "TV SOUND" to "DBS":

- Turn **SOURCE SELECTOR** until "TV SOUND" appears.

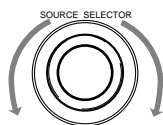

2. Press and hold **SOURCE NAME (LOUDNESS)** until "ASSGN. MD" or "ASSGN. DBS" appears on the display.



Digital Input (DIGITAL IN) Terminal Setting

When you use the digital input terminals, you have to register what components are connected to which terminals (DIGITAL IN 1/2).

Before you start, remember...

- There is a time limit in doing the following steps. If the setting is canceled before you finish, start from step 1 again.

On the front panel ONLY:

1. Press **SETTING** repeatedly until “**DIGITAL IN**” appears on the display.

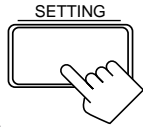

The display changes to show the current setting.

DIGITAL 2 terminal setting

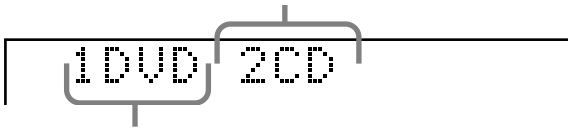

DIGITAL 1 terminal setting

2. Turn **MULTI JOG** to select the appropriate digital terminal setting.

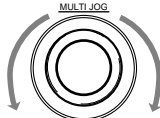

As you turn it, the display changes to show the following:

| | | | | | |
|------------|---|------------|---|-------------|---|
| 1 DVD 2 CD | ⇌ | 1 DVD 2 MD | ⇌ | 1 DVD 2 DBS | ⇌ |
| 1 CD 2 MD | ⇌ | 1 CD 2 DBS | ⇌ | 1 MD 2 DBS | ⇌ |

(back to the beginning)

Note:

When shipped from the factory, the DIGITAL IN terminals can be used as the digital input for the following components.

- DIGITAL 1: For DVD player
- DIGITAL 2: For CD player

Selecting the Analog or Digital Input Mode

When you have connected some components such as CD player, MD recorder, DVD player and the DBS tuner using digital terminals (see page 8), you need to change the input mode for these components to the digital input.

On the front panel:

1. Turn **SOURCE SELECTOR** until the source (CD, MD, DBS, or DVD) for which you want to change the input mode from analog input to digital input appears on the display.

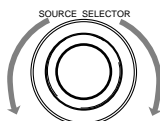

2. Press **INPUT ANALOG/DIGITAL** to change the input mode.

Each time you press the button, the input mode alternates between the digital input and analog input.



From the remote control:

1. Press the source selecting button (CD, TAPE/MD, TV/DBS*, or DVD) for which you want to change the input mode from analog input to digital input.

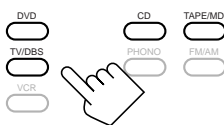

2. Press **ANALOG/DIGITAL** to change the input mode.

Each time you press the button, the input mode alternates between the digital input and analog input.



Notes:

- * Before pressing TV/DBS, make sure that the remote control mode selector on the remote control is set to “CATV/DBS.”
- Once you have set the digital input for these components, it is always used every time you select these components as the source.

IMPORTANT:

The sampling rate converter built in this unit corresponds only to 32kHz, 44.1kHz, and 48kHz. If the signals of a different sampling frequency come into this unit, noise may occur.

Showing the Text Information on the Display

When you have connected an MD recorder or CD player equipped with TEXT COMPU LINK remote control system (see page 34), you can show the text information, such as disc title or track (song) title, on the display of this receiver.

To show it on the display, follow the procedure below.

Before you start, remember..

- There is a time limit in doing the following steps. If the setting is canceled before you finish, start from step 1 again.

On the front panel only:

1. Press **SETTING** repeatedly until “**FL DISPLAY**” appears on the display.

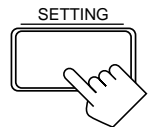

The display changes to show the current setting.

2. Turn **MULTI JOG** to select either the source name or the text information to be shown on the display.

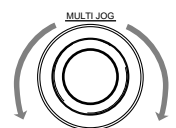

As you turn it, the display changes to show the following:

NORMAL ←→ TEXT

NORMAL: Source name appears during play.

TEXT: Text information appears during play.

Notes:

- Though you have selected “TEXT,” the source name such as “CD” or “MD” appears if a playing disc has no text information.
- Though you have selected “NORMAL,” the setting is changed to “TEXT” in the following case:
 - If the power failure occurs.
 - If you unplug the AC power cord.

Setting the Speakers for the DSP Modes

To obtain the best possible surround sound of the DSP modes, you have to register the information about the speakers arrangement after all connections are completed.

Before you start, remember...

- There is a time limit in doing the following steps. If the setting is canceled before you finish, start from step 1 again.

Front, Center, and Rear Speaker Setting

Register the sizes of all the connected speakers.

- When you change your speakers, you need to register the information about the speakers again.

On the front panel ONLY:

1. Press **SETTING** repeatedly until “**FRONT SPK**” (Front Speaker), “**CENTER SPK**” (Center Speaker) or “**REAR SPK**” (Rear Speaker) appears on the display.

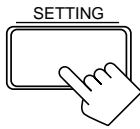

The display changes to show the current setting.

2. Turn **MULTI JOG** to select the appropriate item about the speaker selected in the above step.

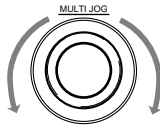

- As you turn it, the display changes to show the following:

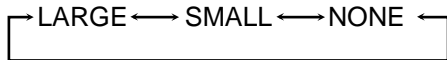

LARGE: Select this when the speaker size is relatively large.

SMALL: Select this when the speaker size is relatively small.

NONE: Select this when you have not connected a speaker. (Not selectable for the front speakers)

3. Repeat steps 1 and 2 to select the appropriate items for the other speakers.

Notes:

- Keep the following comment in mind as reference when adjusting.
 - If the size of the cone speaker unit built in your speaker is greater than 4 3/4 inches (12 cm), select “LARGE,” and if it is smaller than 4 3/4 inches (12 cm), select “SMALL.”
- If you have selected “NO” for the subwoofer setting, you can only select “LARGE” for the front speaker setting.
- If you have selected “SMALL” for the front speaker setting, you cannot select “LARGE” for the center and rear speaker settings.

Center Delay Time Setting

Register the delay time of the sound from the center speaker, comparing that of the sound from the front speakers.

If the distance from your listening point to the center speaker is equal to that to the front speakers, select 0 msec. As the distance to the center speaker becomes shorter, increase the delay time.

- 1 msec increase (or decrease) in delay time corresponds to 11 13/16 inches (30 cm) decrease (or increase) in distance.
- When shipped from the factory, delay time is set to 0 msec.

On the front panel ONLY:

1. Press **SETTING** repeatedly until “**CENTER DELAY**” appears on the display.

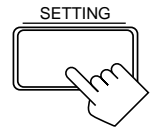

The display changes to show the current setting.

2. Turn **MULTI JOG** to select the delay time of the center speaker output.

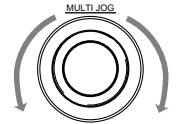

- Turn it clockwise to increase the delay time from 0 msec (“C. DELAY: 0ms”) to 5 msec (“C. DELAY: 5ms”).
- Turn it counterclockwise to decrease the delay time from 5 msec (“C. DELAY: 5ms”) to 0 msec (“C. DELAY: 0ms”).

Rear Delay Time Setting

Register the delay time of the sound from the rear speakers, comparing that of the sound from the front speakers.

If the distance from your listening point to the rear speakers is equal to that to the front speakers, select 0 msec. As the distance to the rear speakers becomes shorter, increase the delay time.

- 1 msec increase (or decrease) in delay time corresponds to 11 13/16 inches (30 cm) decrease (or increase) in distance.
- Rear delay time for Dolby Digital is to be set to 5 msec.
- When shipped from the factory, delay time is set to 5 msec.

On the front panel ONLY:

1. Press **SETTING** repeatedly until “**REAR DELAY**” appears on the display.

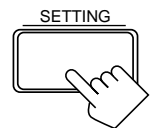

The display changes to show the current setting.

2. Turn **MULTI JOG** to select the delay time of the rear speaker output.

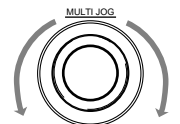

- Turn it clockwise to increase the delay time from 0 msec (“R. DELAY: 0ms”) to 15 msec (“R. DELAY: 15ms”).
- Turn it counterclockwise to decrease the delay time from 15 msec (“R. DELAY: 15ms”) to 0 msec (“R. DELAY: 0ms”).

Crossover Frequency Setting

Small speaker cannot reproduce the bass sound very well. So, if you have used a small speaker any for the front, center, or rear channels, this receiver automatically reallocate the bass elements, originally assigned to the channel for which you have connected the small speaker, to another channel (for which you have connected the large speaker).

To use this function properly, you need to set this crossover frequency level according to the size of the small speaker connected.

- This function takes effect only when playing back a source using Dolby Pro Logic or Dolby Digital. However, if you have selected "LARGE" for all speakers (see page 14), this function will not take effect.

On the front panel ONLY:

1. Press **SETTING** repeatedly until "CROSSOVER FRQ" (Crossover Frequency) appears on the display.

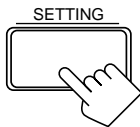

The display changes to show the current setting.

2. Turn **MULTI JOG** to select the crossover frequency level according to the size of the small speaker connected.

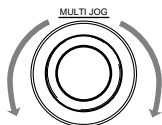

- As you turn it, the display changes to show the following:

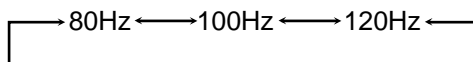

- Use the following comments as reference when adjusting.

| | |
|---------------|--|
| 80Hz: | Select this when the cone speaker unit built in the speaker is about 4 ³ / ₄ inches (12 cm). |
| 100Hz: | Select this when the cone speaker unit built in the speaker is about 3 ¹⁵ / ₁₆ inches (10 cm). |
| 120Hz: | Select this when the cone speaker unit built in the speaker is about 3 ³ / ₁₆ inches (8 cm). |

Low Frequency Effect Attenuator Setting

If the bass sound is distorted while playing back a source using Dolby Digital, follow the procedure below.

On the front panel ONLY:

1. Press **SETTING** repeatedly until "LFE ATT" (Low Frequency Effect Attenuator) appears on the display.

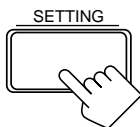

The display changes to show the current setting.

2. Turn **MULTI JOG** to select the low frequency effect attenuator level.

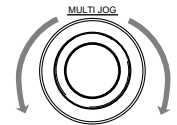

- As you turn it, the display changes to show the following:

0dB ← 10dB

0dB: Normally select this.

10dB: Select this when the bass sound is distorted.

Dynamic Range Compression Setting

You can compress the dynamic range (difference between maximum sound and minimum sound) of the reproduced sound. This is useful when enjoying surround sound at night.

- This function takes effect only when playing back a source using Dolby Digital.

On the front panel ONLY:

1. Press **SETTING** repeatedly until "D. RANGE COMP." (Dynamic Range Compression) appears on the display.

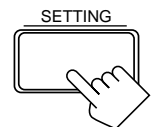

The display changes to show the current setting.

2. Turn **MULTI JOG** to select the appropriate item about the compression level.

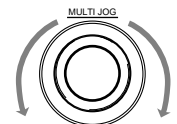

- As you turn it, the display changes to show the following:

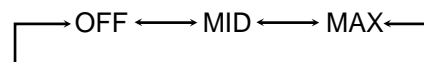

OFF: Select this when you want to enjoy surround with its full dynamic range. (No effect applied.)

MID: Select this when you want to reduce the dynamic range a little. (Factory setting).

MAX: Select this when you want to apply the compression effect fully. (Useful at night).

Storing the Basic Settings and Adjustments — One Touch Operation

JVC's One Touch Operation function is used to assign and store different sound settings for each different playing source. By using this function, you do not have to change the settings every time you change the source. The stored settings for the newly selected source are automatically recalled.

The following can be stored for each source:

- Volume level (see page 10)
- Loudness (see page 11)
- Input attenuator mode (see page 11)
- Subwoofer output level (see page 11)
- Balance (see page 12)
- Analog/digital input mode (see page 13)
- SEA modes (see page 19)
- DSP modes
 - 3D-PHONIC mode settings (see page 23)
 - DAP mode settings (see page 23)
 - Surround mode settings (see page 24)

On the front panel ONLY:

To store the sound settings

1. Press ONE TOUCH OPERATION.

The ONE TOUCH OPERATION lamp lights up, then the previously memorized settings are recalled.



2. Adjust the sound using the functions listed above.

The newly adjusted settings are memorized.

To recall the sound settings

With the ONE TOUCH OPERATION lamp lit, the settings for the currently selected source are recalled when the source is selected.

To cancel the One Touch Operation function

Press ONE TOUCH OPERATION so that the lamp goes off. (Even though the One Touch Operation function is canceled, the recalled sound effects remain active.)

Note:

If the source is FM or AM, you can assign a different setting for each band.

Using the Sleep Timer

Using the Sleep Timer, you can fall asleep to music and know the receiver will turn off by itself rather than play all night.

From the remote control ONLY:

Press SLEEP repeatedly.

The SLEEP indicator lights up on the display, and the shut-off time changes as follows (in minutes):

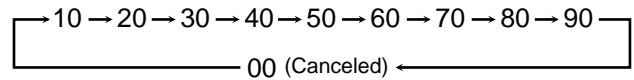

When the shut-off time comes

The receiver turns off automatically.

To check or change the time remaining until the shut-off time

Press SLEEP once.

The remaining time until the shut-off time appears in minutes.

- To change the shut-off time, press SLEEP repeatedly.

To cancel the Sleep Timer

Press SLEEP repeatedly until "SLEEP 00min." appears on the display. (The SLEEP indicator goes off.)

- Turning off the power also cancels the Sleep Timer.

Recording a Source

You can record any source playing through the receiver to a cassette deck (or an MD recorder) connected to the TAPE/MD jacks and the VCR connected to the VCR jacks at the same time.

While recording, you can adjust the volume level, without affecting the sound levels of the recording.

IMPORTANT:

- Before recording a digital source, turn off the DSP mode (see page 20).
- While recording a digital source, do not change the SEA mode (see page 19) or DSP mode (see page 20); otherwise, recording will be interrupted.

Note:

The SEA modes and DSP modes cannot affect the recording while recording an analog source.

Receiving Radio Broadcasts

You can browse through all the stations or use the preset function to go immediately to a particular station.

IMPORTANT:

When using the remote control, check to see if its remote control mode selector is set to the correct position:

To operate this receiver, set it to "AUDIO/TV/VCR" (except when selecting the DBS tuner as the source).

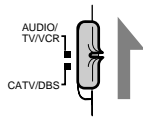

Tuning in Stations Manually

On the front panel:

1. Turn SOURCE SELECTOR to select the band (FM or AM).

The last received station of the selected band is tuned in.

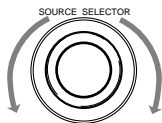
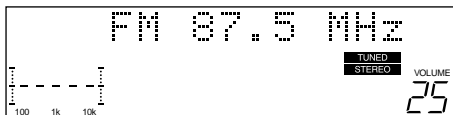

2. Press FM/AM TUNING.

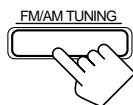

3. Turn MULTI JOG until you find the frequency you want.

- Turning it clockwise increases the frequency.
- Turning it counterclockwise decreases the frequency.
- When you turn MULTI JOG quickly, the frequency keeps changing until a station is tuned in.

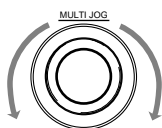

From the remote control:

1. Press FM/AM to select the band.

- Each time you press the button, the band alternates between FM and AM.



2. Press TUNING UP or TUNING DOWN repeatedly until you find the frequency you want.

- When you hold the button, the frequency keeps changing until a station is tuned in.

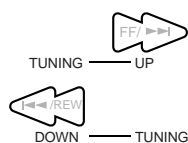

Note:

When a station of sufficient signal strength is tuned in, the TUNED indicator lights up on the display.

When an FM stereo program is received, the STEREO indicator also lights up.

Using Preset Tuning

Once a station is assigned to a channel number, the station can be quickly tuned. You can preset up to 30 FM and 15 AM stations.

To store the preset stations

Before you start, remember...

- There is a time limit in doing the following steps. If the setting is canceled before you finish, start from step 1 again.

On the front panel ONLY:

1. Tune in the station you want to preset (see "Tuning in Stations Manually").

- If you want to store the FM reception mode for this station, select the FM reception mode you want. See "Selecting the FM Reception Mode" on page 18.

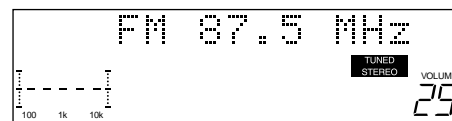

2. Press TUNER/SEA MEMORY.

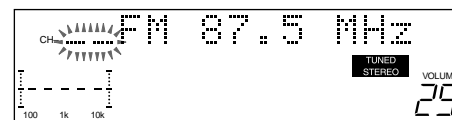

"CH-" appears and the channel number position starts flashing on the display for about 10 seconds.

3. Turn MULTI JOG to select a channel number while the channel number position is flashing.

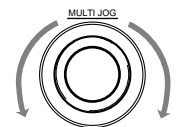

Note:

You can use the 10 keys on the remote control to select the preset number. When using the 10 keys, be sure that they are activated for the tuner, not for the CD and others. (See page 41.)

4. Press TUNER/SEA MEMORY again while the selected channel number is flashing.



The selected channel number stops flashing.

The station is assigned to the selected channel number.

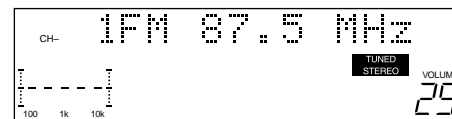

5. Repeat steps 1 to 4 until you store all the stations you want.

To erase a stored preset station

Storing a new station on a used number erases the previously stored one.

To tune in a preset station

On the front panel:

1. Turn **SOURCE SELECTOR** to select the band (FM or AM).

The last received station of the selected band is tuned in.

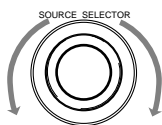

2. Press **TUNER PRESET**.

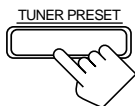

3. Turn **MULTI JOG** until you find the channel you want.

- Turning it clockwise increases the channel numbers.
- Turning it counterclockwise decreases the channel numbers.

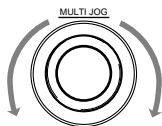

From the remote control:

1. Press **FM/AM**.

- Each time you press the button, the band alternates between FM and AM.

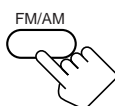

2. Press the 10 keys to select a preset channel number.

- For channel number 5, press 5.
- For channel number 15, press +10 then 5.
- For channel number 20, press +10 then 10.
- For channel number 30, press +10, +10, then 10.

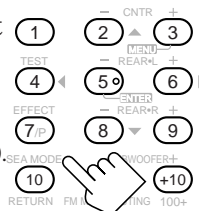

Note:

When you use the 10 keys on the remote control, be sure that they are activated for the tuner, not for the CD and others. (See page 41.)

Selecting the FM Reception Mode

When an FM stereo broadcast is hard to receive or noisy

You can change the FM reception mode while receiving an FM broadcast.

- You can store the FM reception mode for each preset station.

Press **FM MODE** on the front panel or **FM MODE/MUTING** on the remote control.

- Each time you press the button, the FM reception mode alternates between "AUTO" and "MONO."

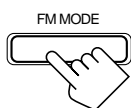

On the front panel

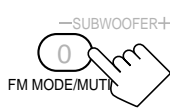

On the remote

AUTO: When a program is broadcasted in stereo, you will hear stereo sound; when in monaural, you will hear monaural sounds. This mode is also useful to suppress static noise between stations. The MUTE AUTO indicator lights up on the display.

MONO: Reception will be improved although you will lose the stereo effect. In this mode, you will hear noise while tuning into the stations. The MUTE AUTO indicator goes off on the display.

Note:

When using the **FM MODE/MUTING** button on the remote control, be sure that the 10 keys are activated for tuner, not for the CD and others. (See page 41.)

Assigning Names to Preset Stations

You can assign a name of up to four characters to each preset station. When a preset station is tuned in, its assigned name will appear on the display.

Before you start, remember...

- There is a time limit in doing the following steps. If the setting is canceled before you finish, start from step 1 again.
- You can use the following characters: Space, A – Z, and 0 – 9.

On the front panel ONLY:

1. Tune in a preset station.

See the left.

2. Press **TUNER/SEA MEMORY**.

The preset channel number starts flashing for about 10 seconds.

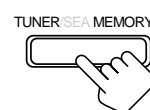

- If you turn **MULTI JOG** while the preset channel number is flashing, you can change the preset channel number.

3. Press **TUNER PRESET**, while the preset channel number is flashing.

The first character position starts flashing.

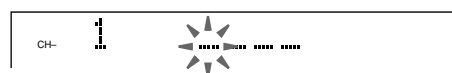
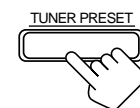

4. Turn **MULTI JOG** to select the first character, while the first character position is flashing.

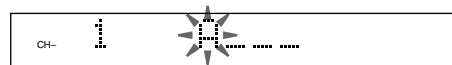
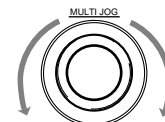

5. Press **TUNER PRESET**, while a character you want is flashing.

The next character position starts flashing.

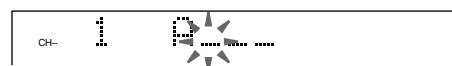
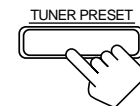

6. Repeat steps 4 and 5 to enter up to four characters.

7. Press **TUNER/SEA MEMORY** while the last selected character is flashing after you have assigned a name.



To erase the input characters

Insert spaces using the same procedure described above.

Using the SEA Modes

The SEA (Sound Effect Amplifier) modes give you control of the way your music sounds.

IMPORTANT:

When using the remote control, check to see if its remote control mode selector is set to the correct position:

To operate this receiver, set it to "AUDIO/TV/VCR" (except when selecting the DBS tuner as the source).

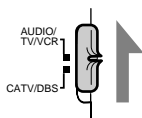

Creating Your Own SEA Mode

You can adjust and store your own SEA adjustment into memory (SEA USERMODE).

Before you start, remember...

- There is a time limit in doing the following steps. If the setting is canceled before you finish, start from step 1 again.

On the front panel ONLY:

If you do not want to store your adjustment, but rather want to adjust the SEA temporarily, skip step 4 below.

Selecting Your Favorite SEA Mode

On the front panel:

Press SEA MODE repeatedly until the SEA mode you want appears on the display.

- Each time you press the button, the SEA mode changes as follows:

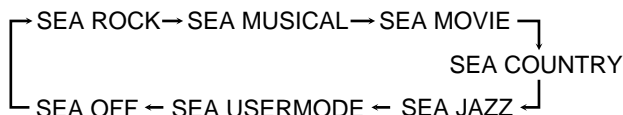

| | |
|----------------------|--|
| SEA ROCK: | Gives a heavy sound. Both high and low frequencies are boosted. |
| SEA MUSICAL: | Enhances the mid-frequency range, which the human voice is mostly made up of. |
| SEA MOVIE: | Adds breadth to sounds so you feel like you are in a movie theater. |
| SEA COUNTRY: | Enhances the high-frequency range so that instruments such as the violin and banjo are emphasized. |
| SEA JAZZ: | Gives a feeling of a live atmosphere. Good for acoustic music. |
| SEA USERMODE: | Your original SEA adjustment (see the right). |
| SEA OFF: | No SEA mode is applied (see below). |

Notes:

- The SEA modes cannot be used for recording.
- When the SEA mode is turned on, the SEA indicator lights up on the display.
- When the SEA mode is used with the DAP mode (see page 23), sounds may be distorted. If this happens, turn off the DAP mode or decrease the effect level of the DAP mode.

To cancel the SEA mode

Press SEA MODE repeatedly until "SEA OFF" appears. The SEA indicator goes off from the display.

From the remote control:

1. Press SOUND.

The 10 keys are activated for sound adjustments.

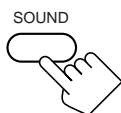

2. Press SEA MODE repeatedly until the SEA mode you want appears on the display.



To cancel the SEA mode

Press SEA MODE repeatedly until "SEA OFF" appears in step 2 above. The SEA indicator goes off from the display.

1. Press SEA ADJUST repeatedly until the frequency range (100Hz, 1kHz or 10kHz) you want appears on the display.

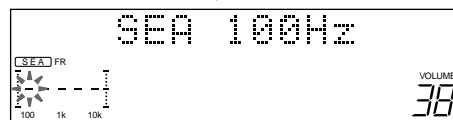
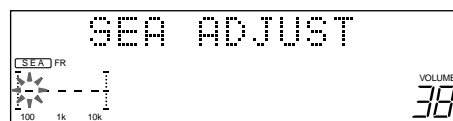

2. Turn MULTI JOG to adjust the SEA level of the selected frequency range.

- Turning it clockwise increases the level.
- Turning it counterclockwise decreases the level.

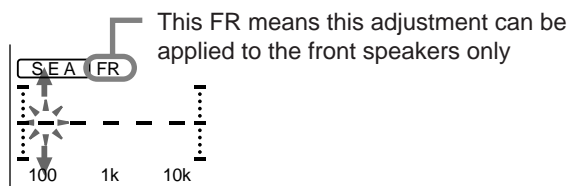
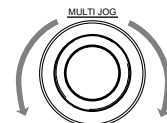

3. Repeat step 1 and 2 to adjust other frequency ranges if necessary.

4. Press TUNER/SEA MEMORY.

Your adjustment is stored into the SEA USERMODE.



To recall your own SEA adjustment

Press SEA MODE repeatedly until "SEA USERMODE" appears.

To erase a stored adjustment

Storing a new adjustment into SEA USERMODE erases the previously stored one.

Using the DSP Modes

The built-in Surround Processor provides three types of the DSP (Digital Signal Processor) mode — 3D-PHONIC mode, DAP (Digital Acoustic Processor) mode and Surround mode.

3D-PHONIC modes

The 3D-PHONIC mode gives you such a nearly surround effect as it is reproduced through the Dolby Surround decoder, which is widely used to reproduce sounds with a feeling of movement like those experienced in movie theaters. The 3D-PHONIC mode is the result of research on sound localization technology carried out at JVC for many years. **This mode can be used when the front speakers are connected to this receiver (without respect to the rear/center speaker connection).**

- You can select either 3D ACTION or 3D THEATER to your preference when playing an analog or Linear PCM (digital) source.
- You can select either 3D DIGITAL or 3D THEATER to your preference when playing a Dolby Digital source.

3D ACTION: Best for action and war movies — where the action is fast and explosive.

3D DIGITAL: Reproduces multi-sound source encoded with Dolby Digital.

3D THEATER: Reproduces the sound field of a large theater. This mode can be selected when only front speakers are connected to this receiver and “REAR SPK” and “CENTER SPK” is set to “NONE” (see page 14).

Note on the subwoofer sound when using the 3D-PHONIC modes

Sounds will or will not come out of the subwoofer according to the selected 3D-PHONIC mode.

- With “3D ACTION” selected: No sound comes out.
- With “3D DIGITAL” selected: Sound comes out if the subwoofer channel signals come into this receiver (**LFE** of the signal indicators lights up— see page 10) while playing a multi-sound source encoded with Dolby Digital.
- With “3D THEATER” selected:
 - If “FRONT SPK” is set to “SMALL,” sound comes out while playing any source.
 - If “FRONT SPK” is set to “LARGE,” sound comes out only if the subwoofer channel signals come into this receiver (**LFE** of the signal indicators lights up — see page 10) while playing a multi-sound source encoded with Dolby Digital.

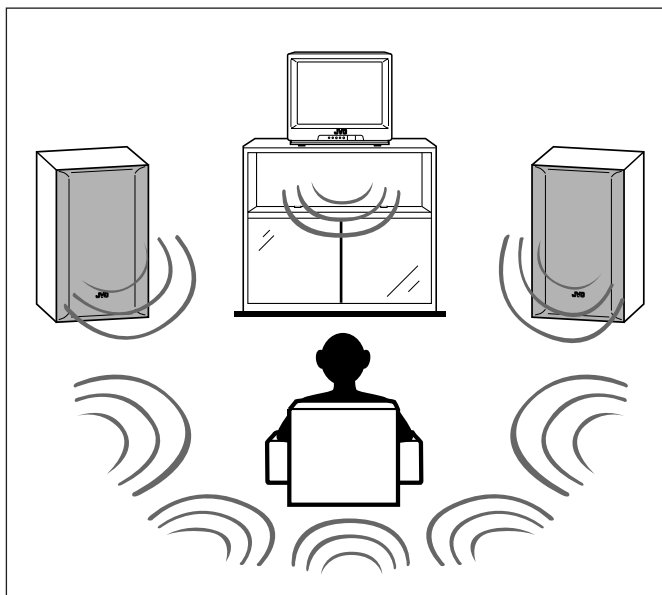

DAP modes

The sound heard in a concert hall or club consists of direct sound and indirect sound — early reflections and reflections from behind. Direct sounds reach the listener directly without any reflection. On the other hand, indirect sounds are delayed by the distances of the ceiling and walls. These direct sounds and indirect sounds are the most important elements of the acoustic surround effects. The DAP mode can create these important elements, and gives you a real “being there” feeling. **This mode can be used when the front speakers are connected to this receiver (without respect to the rear/center speaker connection).**

You can select one of the following to your preference.

LIVE CLUB: Gives the feeling of a live music club with a low ceiling.

DANCE CLUB: Gives a throbbing bass beat.

HALL: Gives clear vocal and the feeling of a concert hall.

PAVILION: Gives the spacious feeling of a pavilion with a high ceiling.

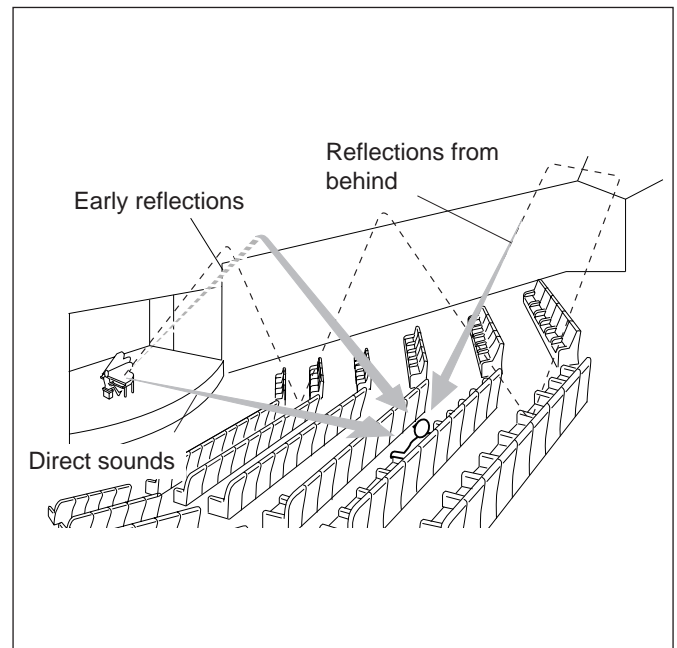

Surround modes

With this receiver, you can use two types of the Surround mode. **Following modes cannot be used when only the front speakers are connected to this receiver (without the rear speakers or center speaker).**

Dolby Surround (Dolby Digital and Dolby Pro Logic)*

Used to reproduce the soundtracks of software encoded with Dolby Digital (bearing the mark ) or with Dolby Surround (bearing the mark ) .

Dolby Digital and Dolby Pro Logic can be selected automatically according to software played back and the speaker arrangement you have done.

- To enjoy the software encoded with Dolby Digital, you must connect the source component using the digital terminal on the rear of this receiver. (See page 8.)

JVC Theater Surround

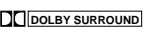
In order to reproduce a more realistic sound field in your listening room while playing soundtracks of software encoded with Dolby Digital (bearing the mark ) , with Dolby Surround (bearing the mark ) , you can use JVC Theater Surround.

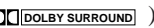
- When playing a source encoded with Dolby Digital (bearing the mark ) , “DIG THEATER” is selected automatically.
- When playing a source encoded with Dolby Surround (bearing the mark ) , “THEATER” is selected automatically.

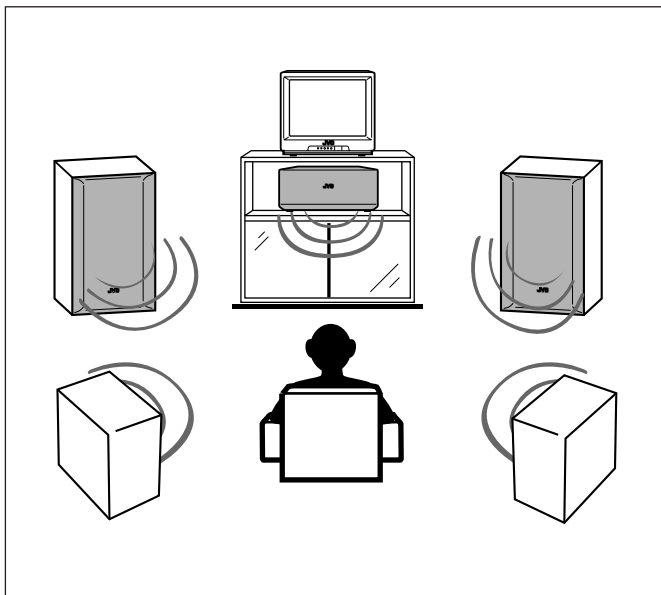

Notes:

- The DSP modes have no effect on monaural sources.
- The DSP modes cannot be used for recording an analog source.
- The PRO LOGIC indicator lights up when the Dolby Pro Logic decoder built in this receiver is activated.
- The  DIGITAL indicator lights up when the signals encoded with Dolby Digital come into the receiver.
- The Dolby Pro Logic decoder is used not only for the analog sources but also for the sources encoded with Dolby Digital in the following cases:
 - When only front channel signals are encoded.
 - When front channel and monaural rear channel signals are encoded.

IMPORTANT:

Before recording a digital source, turn off the DSP mode.

* Manufactured under license from Dolby Laboratories. “Dolby,” “Pro Logic,” and the double-D symbol are trademarks of Dolby Laboratories. Confidential Unpublished Works. ©1992–1998 Dolby Laboratories, Inc. All rights reserved.

Available DSP Modes According to the Speaker Arrangement

Available DSP modes will vary depending on how many speakers are used with this receiver.

Make sure that you have set the speaker information correctly (see page 14).

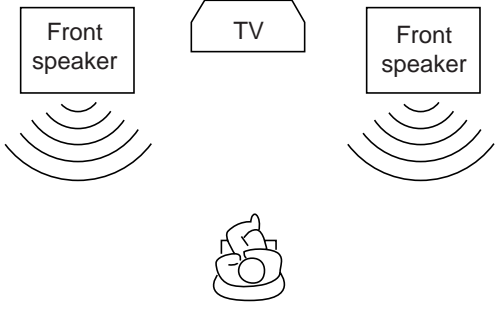
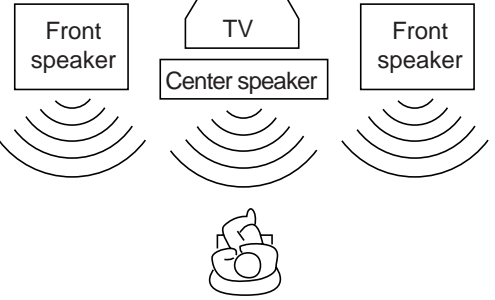
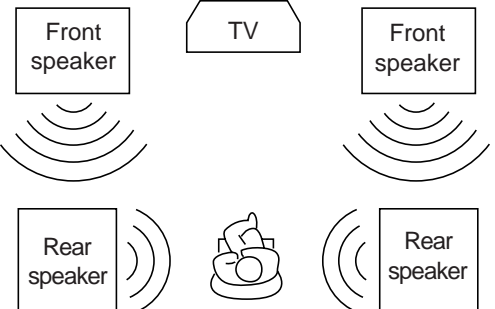
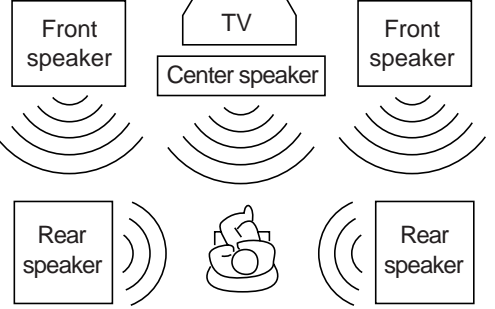
| Speaker arrangements | Available DSP modes |
|---|---|
|  | <p>Each time you press DSP MODE on the front panel or SURROUND MODE on the remote control, the DSP modes change as follows:</p> <ul style="list-style-type: none"> • 3D THEATER • LIVE CLUB • DANCE CLUB • HALL • PAVILION • 3D ACTION (or 3D DIGITAL) • DSP OFF (DSP mode is canceled) |
|  | <p>Each time you press DSP MODE on the front panel or SURROUND MODE on the remote control, the DSP modes change as follows:</p> <div style="display: flex; justify-content: space-between;"> <div style="width: 45%;"> <p>By pressing DSP MODE:</p> <ul style="list-style-type: none"> • THEATER (or DIG THEATER) • LIVE CLUB • DANCE CLUB • HALL • PAVILION • 3D ACTION (or 3D DIGITAL) • DSP OFF (DSP mode is canceled) </div> <div style="width: 45%;"> <p>By pressing SURROUND MODE:</p> <ul style="list-style-type: none"> • DOLBY SURROUND (DOLBY PRO LOGIC, DOLBY DIGITAL) • THEATER (or DIG THEATER) • LIVE CLUB • DANCE CLUB • HALL • PAVILION • 3D ACTION (or 3D DIGITAL) • DSP OFF (DSP mode is canceled) </div> </div> |
|  | <div style="border: 1px solid black; padding: 5px; margin-bottom: 10px;"> <p>To activate the Surround mode, press DOLBY SURROUND button so that the lamp on the button lights up.</p> </div> <div style="border: 1px solid black; padding: 5px;"> <p>To activate the Surround mode, you can also use the SURROUND ON/OFF button.</p> </div> |
|  | <div style="border: 1px solid black; padding: 5px;"> <p>Note on the center speaker sound when using the DSP modes: Sounds come out of the center speaker only if the following take place at the same time;</p> <ul style="list-style-type: none"> • If "CENTER SPK" is set to "LARGE" or "SMALL." • If the center channel signals come into this receiver (C) of the signal indicators lights up — see page 10) while playing a multi-sound source encoded with Dolby Digital. <p>In this case, you cannot adjust the center speaker output level.</p> </div> |

IMPORTANT:

When using the remote control, check to see if its remote control mode selector is set to the correct position:

To operate this receiver, set it to "AUDIO/TV/VCR" (except when selecting the DBS tuner as the source).

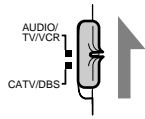

Adjusting the 3D-PHONIC Modes

Once you have adjusted the 3D-PHONIC modes, the adjustment is memorized for each 3D-PHONIC mode.

Before you start, remember...

- Make sure that you have set the speaker information correctly (see page 14).
- There is a time limit in doing the following steps. If the setting is canceled before you finish, start from step 1 again.

On the front panel:

1. Press **DSP MODE** repeatedly until "3D ACTION (or 3D DIGITAL)" or "3D THEATER" appears on the display.

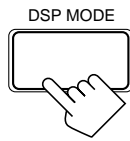

The 3D-PHONIC, DSP, PRO LOGIC and selected 3D-PHONIC mode indicators also light up on the display.

2. Adjust the effect level.

- 1) Press **BALANCE/SURROUND ADJUST** repeatedly until "DSP EFFECT" appears on the display.

The display changes to show the current setting.

- 2) Turn **MULTI JOG** to select the effect level.

- As you turn it, the effect level changes as follows:

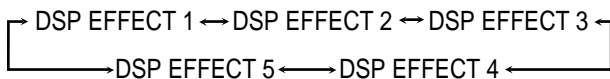
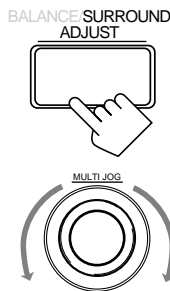

As the number increases, the selected 3D-PHONIC mode becomes stronger.

From the remote control:

1. Press **SURROUND MODE** repeatedly until "3D ACTION (or 3D DIGITAL)" or "3D THEATER" appears on the display.



The 3D-PHONIC, DSP, PRO LOGIC and selected 3D-PHONIC mode indicators also light up on the display.

2. Press **SOUND**.

The 10 keys are activated for sound adjustments.

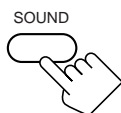

3. Press **EFFECT** to select an effect level you want.

- Each time you press the button, the effect level changes as follows:

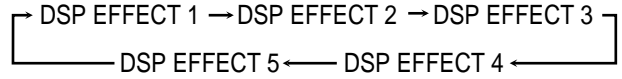

As the number increases, the selected 3D-PHONIC mode becomes stronger.

Adjusting the DAP Modes

Once you have adjusted the DAP modes, the adjustment is memorized for each DAP mode.

Before you start, remember...

- Make sure that you have set the speaker information correctly (see page 14).
- There is a time limit in doing the following steps. If the setting is canceled before you finish, start from step 1 again.
- You cannot adjust the rear speaker output level when you have set "REAR SPK" to "NONE." See page 14.
- When the DAP mode is used with the SEA mode (see page 19), sounds may be distorted. If this happens, turn off the SEA mode.

On the front panel:

1. Press **DSP MODE** repeatedly until the DAP mode — **LIVE CLUB, DANCE CLUB, HALL, or PAVILION** — appears on the display.



The DSP and selected DAP mode indicators also light up on the display.

- When you have set "REAR SPK" to "NONE," the 3D-PHONIC indicator also lights up.

2. Adjust the speaker output levels.

- 1) Press **BALANCE/SURROUND ADJUST** repeatedly until one of the indications appears on the display.

"REAR L LEVEL":

To adjust the left rear speaker level.

"REAR R LEVEL":

To adjust the right rear speaker level.

- 2) Turn **MULTI JOG** to adjust the selected speaker output level (from -10 dB to +10 dB).

- 3) Repeat 1) and 2) to adjust the other speaker output level.

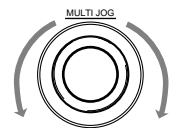

3. Adjust the effect level.

- 1) Press **BALANCE/SURROUND ADJUST** repeatedly until “**DSP EFFECT**” appears on the display.

The display changes to show the current setting.

- 2) Turn **MULTI JOG** to select the effect level.

- As you turn it, the effect level changes as follows:

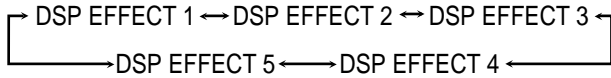

As the number increases, the selected DAP mode becomes stronger.

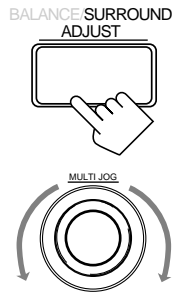

Adjusting the Surround Modes

Once you have adjusted the Surround modes, the adjustment is memorized for each Surround mode.

Dolby Surround adjustments

Before you start, remember...

- Make sure that you have set the speaker information correctly (see page 14).
- There is a time limit in doing the following steps. If the setting is canceled before you finish, start from step 1 again.
- You cannot adjust the rear speaker output levels when you have set “REAR SPK” to “NONE.” See page 14.
- You cannot adjust the center speaker output level when you have set “CENTER SPK” to “NONE.” See page 14.

From the remote control:

1. Press **SURROUND MODE** repeatedly until the DAP mode — **LIVE CLUB, DANCE CLUB, HALL, or PAVILION** — appears on the display.

The DSP and selected DAP mode indicators also light up on the display.



2. Press **SOUND**.

The 10 keys are activated for sound adjustments.

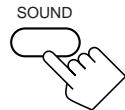

3. Adjust the speaker output levels.

- To adjust the left rear speaker level, press **REAR•L** -/+ (from -10 dB to +10 dB).
- To adjust the right rear speaker level, press **REAR•R** -/+ (from -10 dB to +10 dB).

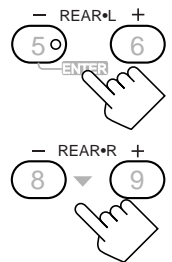

4. Press **EFFECT** to select an effect level you want.

- Each time you press the button, the effect level changes as follows:

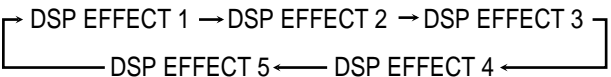

As the number increases, the selected DAP mode becomes stronger.



From the remote control:

1. Press **SURROUND MODE** repeatedly until the mode — **PRO LOGIC or DOLBY DIGITAL** — appears on the display.

- When “PRO LOGIC” is selected, the PRO LOGIC indicator lights up on the display.



Note:

You can also press **SURROUND ON/OFF** to activate an appropriate Surround mode — **PRO LOGIC** or **DOLBY DIGITAL**. Each time you press the button, the Surround mode turns on and off alternately.

2. Press **SOUND**.

The 10 keys are activated for sound adjustments.

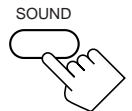

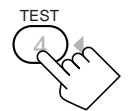
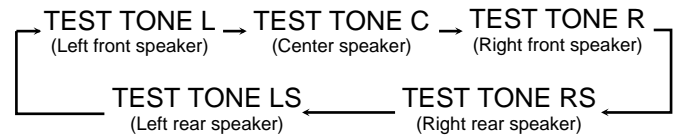

3. Press **TEST** to check the speaker output balance.

“TEST TONE L” starts flashing on the display, and a test tone comes out of the speakers in the following order:

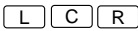

Notes:

- You can adjust the speaker output levels without outputting the test tone.
- No test tone comes out of the center speaker when "CENTER SPK" is set to "NONE" (see page 14).
- No test tone comes out of the rear speakers when "REAR SPK" is set to "NONE" (see page 14).
- If the TV is turned on and the proper video input is selected on the TV, the test tone screen will appear on the TV.
- The signal indicators also light on the display while the test tone comes out of the speakers.

- L: Lights when the test tone comes out of the left front speaker. 
- C: Lights when the test tone comes out of the center speaker. 
- R: Lights when the test tone comes out of the right front speaker.
- RS: Lights when the test tone comes out of the right rear speaker.
- LS: Lights when the test tone comes out of the left rear speaker.

4. Adjust the speaker output levels.

- To adjust the center speaker level, press CNTR $-/+$ (from -10 dB to $+10$ dB).
- To adjust the left rear speaker level, press REAR•L $-/+$ (from -10 dB to $+10$ dB).
- To adjust the right rear speaker level, press REAR•R $-/+$ (from -10 dB to $+10$ dB).

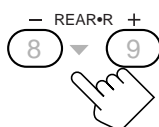
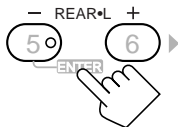
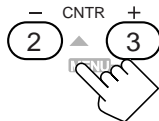

5. Press TEST again to stop the test tone.



On the front panel:

You can also use the buttons on the front panel to adjust the Surround modes. However, no test tone is available when using the buttons on the front panel. So, make adjustments while listening to the sound of the source played back.

1. Press DOLBY SURROUND to activate an appropriate Surround mode — PRO LOGIC or DOLBY DIGITAL.



- Each time you press the button, the Surround mode turns on and off alternately.
- When "PRO LOGIC" is selected, the PRO LOGIC indicator lights up on the display.

2. Adjust the speaker output levels.

- 1) Press **BALANCE/SURROUND ADJUST** repeatedly until one of the indications appears on the display.
 - "CENTER LEVEL": To adjust the center speaker level.
 - "REAR L LEVEL": To adjust the left rear speaker level.
 - "REAR R LEVEL": To adjust the right rear speaker level.
- 2) Turn **MULTI JOG** to adjust the selected speaker output level (from -10 dB to $+10$ dB).
- 3) Repeat 1) and 2) to adjust the other speaker output levels.

BALANCE/SURROUND ADJUST

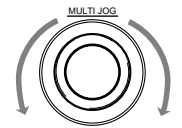

JVC Theater Surround adjustments

Before you start, remember...

- Make sure that you have set the speaker information correctly (see page 14).
- There is a time limit in doing the following steps. If the setting is canceled before you finish, start from step 1 again.
- You cannot adjust the rear speaker output levels when you have set "REAR SPK" to "NONE." See page 14.
- You cannot adjust the center speaker output level and center tone when you have set "CENTER SPK" to "NONE." See page 14.

From the remote control:

1. Press SURROUND MODE repeatedly until "THEATER" or "DIG THEATER" appears on the display.



- When "THEATER" is selected, the PRO LOGIC, DSP, and THEATER indicators also light up on the display.
- When "DIG THEATER" is selected, the DSP, THEATER and DIGITAL indicators also light up on the display.

2. Press SOUND.

The 10 keys are activated for sound adjustments.

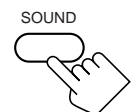

3. Press TEST to check the speaker output balance.

“TEST TONE L” starts flashing on the display, and a test tone comes out of the speakers in the following order:

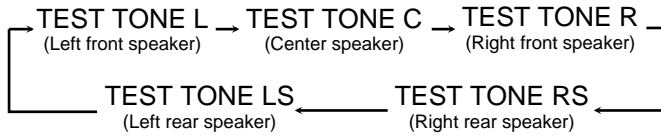
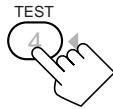

Notes:

- You can adjust the speaker output levels without outputting the test tone.
- No test tone comes out of the center speaker when “CENTER SPK” is set to “NONE” (see page 14).
- No test tone comes out of the rear speakers when “REAR SPK” is set to “NONE” (see page 14).
- If the TV is turned on and the proper video input is selected on the TV, the test tone screen will appear on the TV.
- The signal indicators also light on the display while the test tone comes out of the speaker.

- L: Lights when the test tone comes out of the left front speaker. L C R
- C: Lights when the test tone comes out of the center speaker. LS RS
- R: Lights when the test tone comes out of the right front speaker.
- RS: Lights when the test tone comes out of the right rear speaker.
- LS: Lights when the test tone comes out of the left rear speaker.

4. Adjust the speaker output levels.

- To adjust the center speaker level, press CNTR $-/+$ (from -10 dB to $+10$ dB).
- To adjust the left rear speaker level, press REAR•L $-/+$ (from -10 dB to $+10$ dB).
- To adjust the right rear speaker level, press REAR•R $-/+$ (from -10 dB to $+10$ dB).

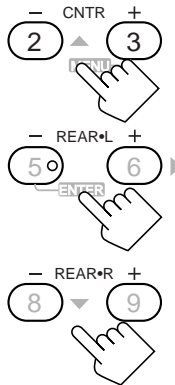

5. Press TEST again to stop the test tone.



6. Press EFFECT to select an effect level you want.

- Each time you press the button, the effect level changes as follows:

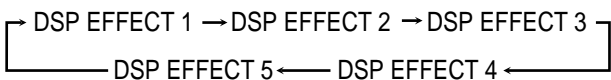

As the number increases, JVC Theater Surround becomes stronger.

On the front panel:

You can also use the buttons on the front panel to adjust the Surround modes. However, no test tone is available when using the buttons on the front panel. So, make adjustments while listening to the sound of the source played back.

1. Press DSP MODE repeatedly until “THEATER” or “DIG THEATER” appears on the display.



- When “THEATER” is selected, the PRO LOGIC, DSP, and THEATER indicators light up on the display.
- When “DIG THEATER” is selected, the DSP and THEATER indicators light up on the display.

2. Adjust the speaker output levels.

1) Press BALANCE/SURROUND ADJUST repeatedly until one of the indications appears on the display.



- “CENTER LEVEL”:
To adjust the center speaker level.
- “REAR L LEVEL”:
To adjust the left rear speaker level.
- “REAR R LEVEL”:
To adjust the right rear speaker level.

2) Turn MULTI JOG to adjust the selected speaker output level (from -10 dB to $+10$ dB).

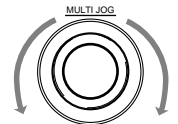

3) Repeat 1) and 2) to adjust the other speaker output levels.

3. Adjust the effect level.

1) Press BALANCE/SURROUND ADJUST repeatedly until “DSP EFFECT” appears on the display.



The display changes to show the current setting.

2) Turn MULTI JOG to select the effect level.

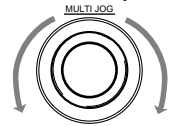

As you turn it, the effect level changes as follows:

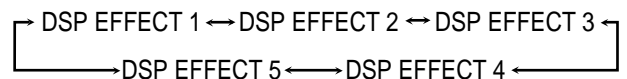

As the number increases, JVC Theater Surround becomes stronger.

Activating the DSP Modes

You can use only one DSP mode at a time. When a DSP mode is activated, another DSP mode is canceled if in use.

For Dolby Pro Logic and Dolby Digital Surround



On the front panel:

1. Press DOLBY SURROUND so that the lamp on the button lights up.

- Each time you press the button, the Dolby Surround turns on and off alternately.

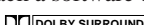

2. Select and play a sound source.

- To enjoy Dolby Pro Logic, play back a software encoded with Dolby Surround and labeled with  mark.
- To enjoy Dolby Digital, play back a software encoded with Dolby Digital and labeled with  mark.

To cancel the Dolby Surround mode

Press DOLBY SURROUND again so that the lamp on the button goes off. (“SURROUND OFF” appears on the display.)





From the remote control:

1. Press SURROUND ON/OFF so that the lamp on the DOLBY SURROUND button on the front panel lights up.

- Each time you press the button, the Dolby Surround turns on and off alternately.
- You can also turn on Dolby Surround by pressing SURROUND MODE. (See page 22 for more details.)

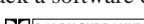

2. Select and play a sound source.

- To enjoy Dolby Pro Logic, play back a software encoded with Dolby Surround and labeled with  mark.
- To enjoy Dolby Digital, play back a software encoded with Dolby Digital and labeled with  mark.

To cancel the Dolby Surround mode

Press SURROUND ON/OFF again. (“SURROUND OFF” appears on the display.)



For the other DSP modes



On the front panel:

1. Press DSP MODE repeatedly until the mode you want appears on the display.

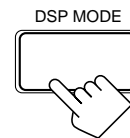
- Each time you press the button, the DSP modes change. (See page 22 for more details.)

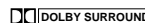

2. Select and play a sound source.

- To enjoy 3D-PHONIC and JVC Theater Surround, play back a software:
 - encoded with Dolby Surround and labeled with  mark.
 - encoded with Dolby Digital and labeled with  mark.

To cancel the DSP mode

Press DSP MODE repeatedly until “DSP OFF” appears on the display.

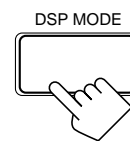



From the remote control:

1. Press SURROUND MODE repeatedly until the DSP mode you want appears on the display.

- Each time you press the button, the DSP modes change. You can also turn on Dolby Surround. (See page 22 for more details.)

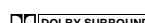

2. Select and play a sound source.

- To enjoy 3D-PHONIC and JVC Theater Surround, play back a software:
 - encoded with Dolby Surround and labeled with  mark.
 - encoded with Dolby Digital and labeled with  mark.

To cancel the DSP mode

Press SURROUND MODE repeatedly until “DSP OFF” appears on the display.



Using the On-Screen Menus

You can use the Menus on the TV screen to control the receiver.

To use this function, you need to connect the TV to the MONITOR OUT jack on the rear panel (see page 7), and set the TV's input mode to the proper position to which the receiver is connected.

- When the TV's input mode is incorrect; for example, a different video input or TV tuner mode is selected, you cannot show the Menus on the TV screen.

On-Screen Operation buttons (on the remote control)

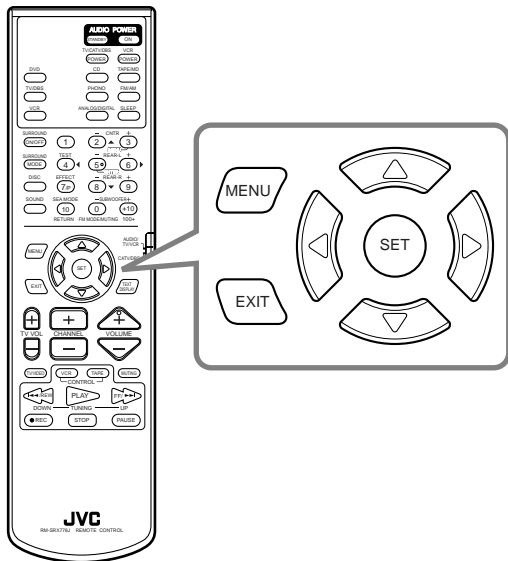

Selecting the Source to Play (Also see page 9)

1. Press MENU.

The MAIN MENU appears on the TV.

- Pressing one of the Δ / ∇ / \triangleleft / \triangleright buttons also displays the MAIN MENU.

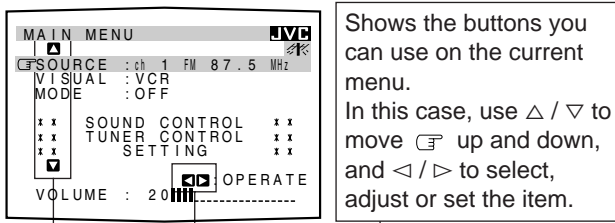

Note:

The on-screen display will disappear if no operation is done for about 1 minute.

2. Press Δ / ∇ to move to "SOURCE."

3. Press \triangleleft / \triangleright to select the source.

4. When you finish, press EXIT.

The menu disappears from the TV.

Selecting the Different Source for Picture and Sound (Also see page 10)

1. Press MENU.

The MAIN MENU appears on the TV.

- Pressing one of the Δ / ∇ / \triangleleft / \triangleright buttons also displays the MAIN MENU.

2. Press Δ / ∇ to move to "VISUAL."

3. Press \triangleleft / \triangleright to select a different video source.

4. When you finish, press EXIT.

The menu disappears from the TV.

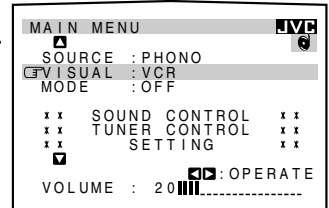

Activating the DSP Modes (Also see page 27)

1. Press MENU.

The MAIN MENU appears on the TV.

- Pressing one of the Δ / ∇ / \triangleleft / \triangleright buttons also displays the MAIN MENU.

2. Press Δ / ∇ to move to "MODE."

3. Press \triangleleft / \triangleright to select the DSP mode you want to use.

4. When you finish, press EXIT.

The menu disappears from the TV.

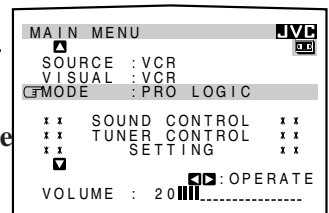

Adjusting the Front Speaker Output Balance (Also see page 12)

1. Press MENU.

The MAIN MENU appears on the TV.

- Pressing one of the Δ / ∇ / \triangleleft / \triangleright buttons also displays the MAIN MENU.

2. Press Δ / ∇ to move to "SOUND CONTROL," then press \triangleleft / \triangleright .

The SOUND CONTROL menu appears.

3. Press Δ / ∇ to move to "BAL." (Balance).

4. Press \triangleleft / \triangleright to adjust the balance.

5. When you finish, press EXIT repeatedly until the menu disappears from the TV.

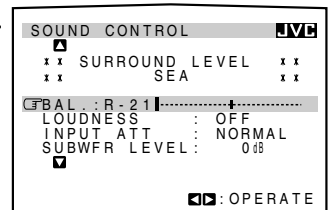

■ Listening at Low Volume (Loudness)

(Also see page 11)

1. Press MENU.

The MAIN MENU appears on the TV.

- Pressing one of the Δ / ∇ / \triangleleft / \triangleright buttons also displays the MAIN MENU.

2. Press Δ / ∇ to move \leftarrow to “SOUND CONTROL,” then press \triangleleft / \triangleright .

The SOUND CONTROL menu appears.

3. Press Δ / ∇ to move \leftarrow to “LOUDNESS.”

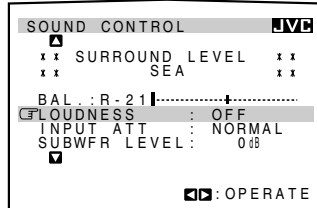

4. Press \triangleleft / \triangleright to turn the loudness “ON” or “OFF.”

5. When you finish, press EXIT repeatedly until the menu disappears from the TV.

■ Attenuating the Input Signal

(Also see page 11)

1. Press MENU.

The MAIN MENU appears on the TV.

- Pressing one of the Δ / ∇ / \triangleleft / \triangleright buttons also displays the MAIN MENU.

2. Press Δ / ∇ to move \leftarrow to “SOUND CONTROL,” then press \triangleleft / \triangleright .

The SOUND CONTROL menu appears.

3. Press Δ / ∇ to move \leftarrow to “INPUT ATT.”

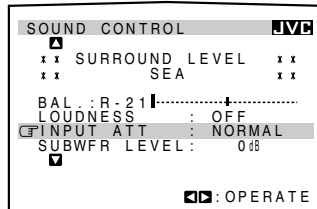

4. Press \triangleleft / \triangleright to turn the Input Attenuator mode “ATT ON” or “NORMAL.”

5. When you finish, press EXIT repeatedly until the menu disappears from the TV.

■ Adjusting the Subwoofer Output Level

(Also see page 11)

1. Press MENU.

The MAIN MENU appears on the TV.

- Pressing one of the Δ / ∇ / \triangleleft / \triangleright buttons also displays the MAIN MENU.

2. Press Δ / ∇ to move \leftarrow to “SOUND CONTROL,” then press \triangleleft / \triangleright .

The SOUND CONTROL menu appears.

3. Press Δ / ∇ to move \leftarrow to “SUBWFR LEVEL.”

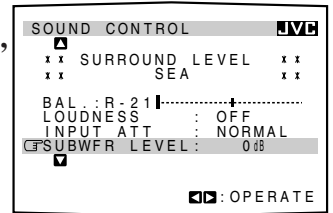

4. Press \triangleleft / \triangleright to adjust the subwoofer output level.

5. When you finish, press EXIT repeatedly until the menu disappears from the TV.

■ Adjusting the DSP Modes

(Also see pages 23 – 26)

1. Press MENU.

The MAIN MENU appears on the TV.

- Pressing one of the Δ / ∇ / \triangleleft / \triangleright buttons also displays the MAIN MENU.

2. Press Δ / ∇ to move \leftarrow to “MODE.”

3. Press \triangleleft / \triangleright to select the DSP mode you want to adjust.

- In this example, “THEATER” is selected.

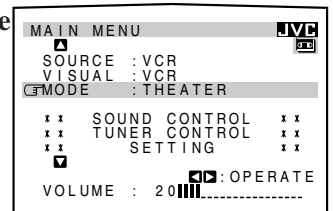

4. Press Δ / ∇ to move \leftarrow to “SOUND CONTROL,” then press \triangleleft / \triangleright .

The SOUND CONTROL menu appears.

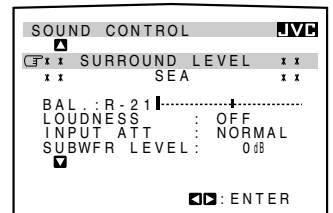

5. Press Δ / ∇ to move \leftarrow to “SURROUND LEVEL,” then press \triangleleft / \triangleright .

The SURROUND LEVEL menu appears.

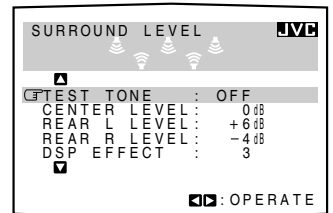

6. Press Δ / ∇ to move \leftarrow to the item you want to set or adjust, then press \triangleleft / \triangleright .

On these adjustment menus, you can do the following:

For 3D-PHONIC (3D ACTION, 3D DIGITAL, 3D THEATER):

“DSP EFFECT”: Select the effect level.

For DAP (LIVE CLUB, DANCE CLUB, HALL, PAVILION):

“REAR L LEVEL”: Adjust the left rear speaker output level. *

“REAR R LEVEL”: Adjust the right rear speaker output level. *

“DSP EFFECT”: Select the effect level.

For Dolby Pro Logic:

- “TEST TONE”: Output a test tone.
- “CENTER LEVEL”: Adjust the center speaker output level. **
- “REAR L LEVEL”: Adjust the left rear speaker output level. *
- “REAR R LEVEL”: Adjust the right rear speaker output level. *

For Dolby Digital Surround:

- “TEST TONE”: Output a test tone.
- “CENTER LEVEL”: Adjust the center speaker output level. **
- “REAR L LEVEL”: Adjust the left rear speaker output level. *
- “REAR R LEVEL”: Adjust the right rear speaker output level. *

For JVC Theater Surround:

- “TEST TONE”: Output a test tone.
- “CENTER LEVEL”: Adjust the center speaker output level. **
- “REAR L LEVEL”: Adjust the left rear speaker output level. *
- “REAR R LEVEL”: Adjust the right rear speaker output level. *
- “DSP EFFECT”: Select the effect level.

Notes:

- * Not displayed when “REAR SPK” is set to “NONE” (see page 14).
- **Not displayed when “CENTER SPK” is set to “NONE” (see page 14).

- When you finish, press EXIT repeatedly until the menu disappears from the TV.

Selecting Your Favorite SEA Mode

(Also see page 19)

- Press MENU.

The MAIN MENU appears on the TV.
• Pressing one of the $\Delta / \nabla / \triangleleft / \triangleright$ buttons also displays the MAIN MENU.

- Press Δ / ∇ to move \square to “SOUND CONTROL,” then press $\triangleleft / \triangleright$.

The SOUND CONTROL menu appears.

- Press Δ / ∇ to move \square to “SEA,” then press $\triangleleft / \triangleright$.

The SEA menu appears.

- Press Δ / ∇ to move \square to “SEA MODE.”

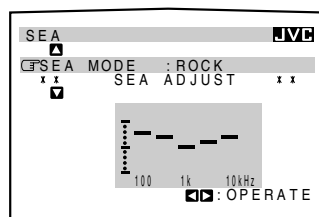

- Press $\triangleleft / \triangleright$ to select the SEA mode you want.
- When you finish, press EXIT repeatedly until the menu disappears from the TV.

Creating Your Own SEA Mode

(Also see page 19)

- Press MENU.

The MAIN MENU appears on the TV.

- Pressing one of the $\Delta / \nabla / \triangleleft / \triangleright$ buttons also displays the MAIN MENU.

- Press Δ / ∇ to move \square to “SOUND CONTROL,” then press $\triangleleft / \triangleright$.

The SOUND CONTROL menu appears.

- Press Δ / ∇ to move \square to “SEA,” then press $\triangleleft / \triangleright$.

The SEA menu appears.

- Press Δ / ∇ to move \square to “SEA ADJUST.”

The SEA ADJUST menu appears.

- Press $\Delta / \nabla / \triangleleft / \triangleright$ to adjust the SEA mode as you want.

$\triangleleft / \triangleright$: Select the frequency ranges.

Δ / ∇ : Adjust the frequency levels.

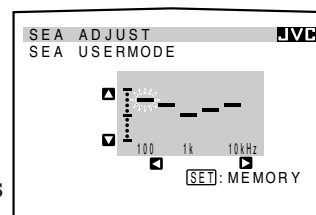

- Press SET to store the setting into the SEA USERMODE.

- If you press EXIT, without pressing SET in this step, you can return to the SEA menu. (The adjustment you have made is active but not stored.)

- When you finish, press EXIT repeatedly until the menu disappears from the TV.

■ Setting the Basic Setting Items (Also see pages 12 – 15)

1. Press MENU.

The MAIN MENU appears on the TV.

- Pressing one of the Δ / ∇ / \triangleleft / \triangleright buttons also displays the MAIN MENU.

2. Press Δ / ∇ to move \leftarrow to “SETTING,” then press \triangleleft / \triangleright .

The SETTING 1 or SETTING 2 menu appears.

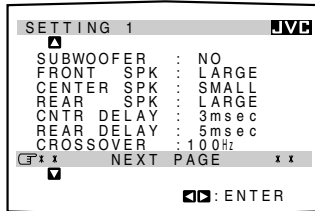

3. Press Δ / ∇ to move \leftarrow to the item you want to set or adjust, then press \triangleleft / \triangleright .

- To go to the SETTING 2 menu, move \leftarrow to “NEXT PAGE,” then press \triangleleft / \triangleright .
- To go back to the SETTING 1 menu, move \leftarrow to “PREVIOUS PAGE,” then press \triangleleft / \triangleright .

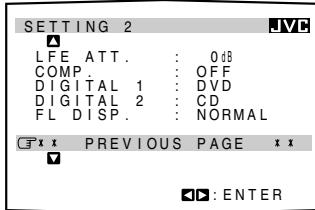

On the SETTING 1 and 2 menus, you can do the following:

- “SUBWOOFER”: Set the subwoofer information (see page 12).
- “FRONT SPK”: Set the front speaker information (see page 14).
- “CENTER SPK”: Set the center speaker information (see page 14).
- “REAR SPK”: Set the rear speaker information (see page 14).
- “CNTR DELAY”: Adjust the delay time of the center speaker output (see page 14). *
- “REAR DELAY”: Adjust the delay time of the rear speaker output (see page 14). **
- “CROSSOVER”: Set the crossover frequency (see page 15).
- “LFE ATT.”: Set the low frequency effect attenuator level (see page 15).
- “COMP.”: Set the dynamic range compression (see page 15).
- “DIGITAL 1/2”:
- “FL DISP.”: Set whether or not to show the disc text information on the display (see page 13).

Notes:

- * Not adjustable when “CENTER SPK” is set to “NONE” (see page 14).
- **Not adjustable when “REAR SPK” is set to “NONE” (see page 14).

4. When you finish, press EXIT repeatedly until the menu disappears from the TV.

■ Operating the Tuner (Also see pages 17 and 18)

1. Press MENU.

The MAIN MENU appears on the TV.

- Pressing one of the Δ / ∇ / \triangleleft / \triangleright buttons also displays the MAIN MENU.

2. Press Δ / ∇ to move \leftarrow to “TUNER CONTROL,” then press \triangleleft / \triangleright .

The TUNER CONTROL menu appears.

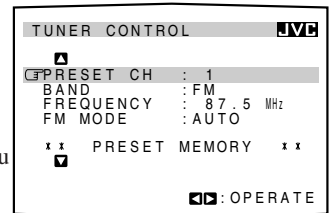

3. Press Δ / ∇ to move \leftarrow to the item you want to set or adjust, then press \triangleleft / \triangleright .

On the TUNER CONTROL menu, you can do the following:

- “PRESET CH”: Select a preset channel station.
- “BAND”:
- “FREQUENCY”:
- “FM MODE”:
- “PRESET MEMORY”: See “Storing the Preset Stations” on the next page.

Note:

- * Not displayed when an AM station is selected.

4. When you finish, press EXIT repeatedly until the menu disappears from the TV.

■ Storing the Preset Stations (Also see page 17)

1. Press MENU.

The MAIN MENU appears on the TV.

- Pressing one of the $\Delta / \nabla / \triangleleft / \triangleright$ buttons also displays the MAIN MENU.

2. Press Δ / ∇ to move \leftarrow to “TUNER CONTROL,” then press $\triangleleft / \triangleright$.

The TUNER CONTROL menu appears.

3. Tune into a station on the TUNER CONTROL menu, referring to “Operating the Tuner” on the previous page.

4. Press Δ / ∇ to move \leftarrow to “PRESET MEMORY,” then press $\triangleleft / \triangleright$.

The PRESET MEMORY menu appears.

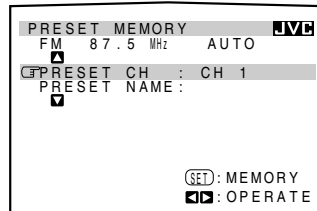

5. Press $\triangleleft / \triangleright$ to select a preset station number you want.

6. Press SET to store the setting.

7. When you finish, press EXIT repeatedly until the menu disappears from the TV.

■ Assigning Names to Preset Stations (Also see page 18)

1. Press MENU.

The MAIN MENU appears on the TV.

- Pressing one of the $\Delta / \nabla / \triangleleft / \triangleright$ buttons also displays the MAIN MENU.

2. Press Δ / ∇ to move \leftarrow to “TUNER CONTROL,” then press $\triangleleft / \triangleright$.

The TUNER CONTROL menu appears.

3. Press Δ / ∇ to move \leftarrow to “PRESET CH.”

4. Press $\triangleleft / \triangleright$ to select a preset station.

5. Press Δ / ∇ to move \leftarrow to “PRESET MEMORY,” then press $\triangleleft / \triangleright$.

The PRESET MEMORY menu appears.

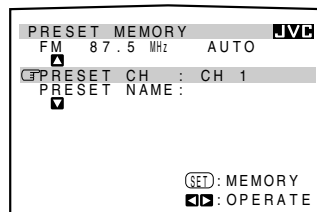

6. Press Δ / ∇ to move \leftarrow to “PRESET NAME,” then press SET.

The character entry screen appears.

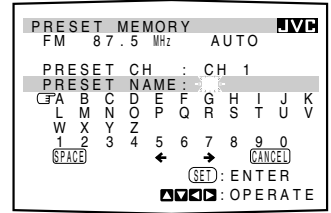

7. Press $\Delta / \nabla / \triangleleft / \triangleright$ to move \leftarrow in front of a character you want.

You can also select the following:

SPACE : To enter space

CANCEL : To erase the character

$\triangleleft \rightarrow$: To go back to the previous character position or go to the next character position

8. Press SET to enter the selected character.

9. Repeat steps 7 and 8 to enter up to four characters.

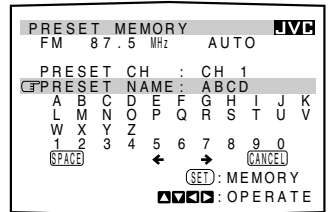

10. Press $\Delta / \nabla / \triangleleft / \triangleright$ to move \leftarrow to “PRESET NAME,” then press SET to store the setting.

The TUNER CONTROL menu appears again.

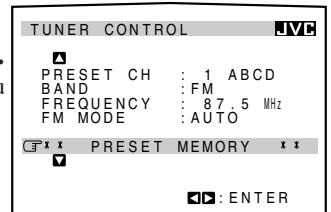

11. When you finish, press EXIT repeatedly until the menu disappears from the TV.

COMPU LINK Remote Control System

The COMPU LINK remote control system allows you to operate JVC audio components through the remote sensor on the receiver.

To use this remote control system, you need to connect JVC audio components through the COMPU LINK-3 (SYNCHRO) jacks (see below) in addition to the connections using cables with RCA pin plugs (see page 6).

- Make sure that the AC power cords of these components are unplugged before connection. Plug the AC power cords only after all connections are complete.

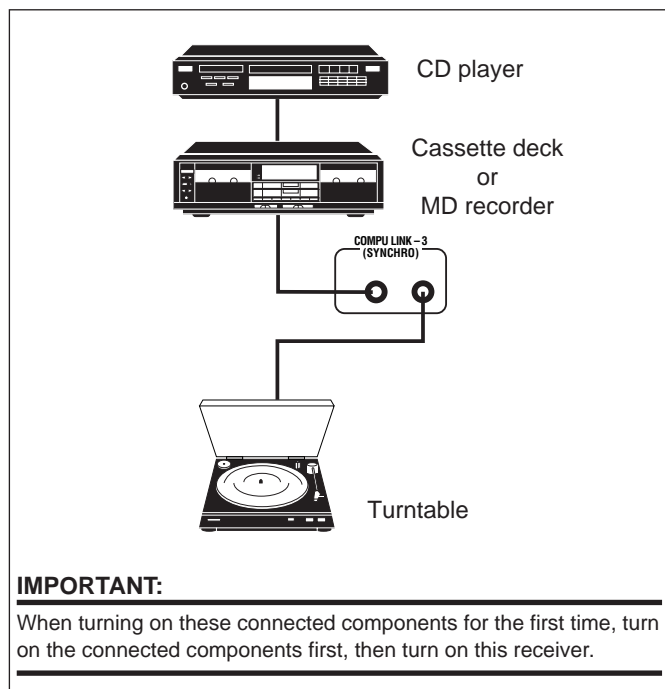

IMPORTANT:

When turning on these connected components for the first time, turn on the connected components first, then turn on this receiver.

Notes:

- If your audio component has two COMPU LINK-3 (SYNCHRO) jacks, you can use either one. If it has only one COMPU LINK-3 (SYNCHRO) jack, connect it so that it is the last item in the series of components. (For example, the turntable or CD player in the diagram above.)
- To operate the cassette deck or MD recorder using the COMPU LINK remote control system, set the source name correctly. (See page 12.)
- Refer also to the manuals supplied with your audio components.

This remote control system allows you to use four functions listed below.

Remote Control through the Remote Sensor on the Receiver

You can control the connected audio components through the remote sensor on the receiver using this remote control. Aim the remote control directly at the remote sensor on the receiver. For details, see pages 41 and 42.

Automatic Source Selection

When you press the play (▶) button on a connected component or on its own remote control, the receiver automatically turns on and changes the source to the component. On the other hand, if you select a new source on the receiver or on the remote control, the selected component begins playing immediately.

In both cases, the previously selected source continues playing without sound for a few seconds.

Automatic Power On/Off (Standby): only possible with the COMPU LINK-3 connection

Both the CD player and cassette deck (or MD recorder) turn on and off (standby) along with the receiver.

When you turn on the receiver, the CD player or cassette deck (or MD recorder) will turn on automatically, depending on which component has been previously selected.

When you turn off the receiver, both the CD player and cassette deck (or MD recorder) will turn off (standby).

Synchronized Recording

Synchronized recording means the cassette deck (or MD recorder) starts recording as soon as a CD or a record begins playing.

To use synchronized recording, follow these steps:

1. Put a tape in the cassette deck (or an MD in the MD recorder), and a disc in the CD player (or a record on the turntable).
2. Press the record (●) button and the pause (⏸) button on the cassette deck (or MD recorder) at the same time.

This puts the cassette deck (or MD recorder) into recording pause.

If you do not press the record (●) button and pause (⏸) button at the same time, the synchronized recording feature will not operate.

3. Press the play (▶) button on the CD player or on the turntable.

The source changes on the receiver, and as soon as play starts, the cassette deck (or MD recorder) starts recording. When the play ends, the cassette deck (or MD recorder) enters recording pause, and stops about 4 seconds later.

Notes:

- During synchronized recording, the selected source cannot be changed.
- If the power of any component is shut off during synchronized recording, the COMPU LINK remote control system may not operate properly. In this case, you must start again from the beginning.

TEXT COMPU LINK Remote Control System

The TEXT COMPU LINK remote control system has been newly developed to deal with the disc information recorded in the CD Text* and MDs. Using these information in the discs, you can operate the CD player or MD recorder equipped with the TEXT COMPU LINK remote control system through the receiver.

CONNECTIONS:

To use this remote control system, you need to connect the CD player and/or MD recorder you want to operate, following the procedures below.

1. If you have already plugged your CD player, MD recorder, and this receiver into the AC outlets, unplug their AC power cords first.
2. Connect your CD player, MD recorder, and this receiver as follows, through the COMPU LINK-3 (SYNCHRO) jacks and TEXT COMPU LINK jacks.

- 1) **COMPU LINK-3 (SYNCHRO) jacks:** Use the cables with the monaural mini-plugs (not supplied with this receiver).

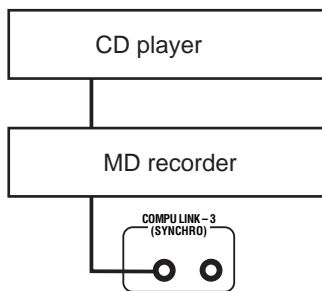

- 2) **TEXT COMPU LINK jacks:** Use the cables with the stereo mini-plugs (not supplied with this receiver).

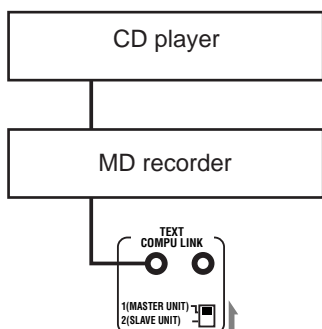

IMPORTANT:

Set the Master/Slave Selector on the rear to "1(MASTER UNIT)."

- "2(SLAVE UNIT)" is just for the serviceman's use. The TEXT COMPU LINK remote control system does not function with the selector set to "2(SLAVE UNIT)."

3. Connect your CD player, MD recorder and this receiver, using the cables with RCA pin plugs (see page 6).
4. Plug the AC power cords of these components above into the AC outlets.
5. When turning on these components for the first time, turn on the connected components first, then turn on this receiver.

FUNCTIONS:

This remote control system allows you to use the functions listed below.

Displaying the Disc Information on the TV screen

Disc information such as its performer and disc title (and track titles only when a CD Text is selected) is shown on the TV screen.

Disc Search: Only for CD Player

This remote control system can allow you to search discs by the performer, disc title, and music genre. With this disc search, you can easily find the disc you want to play.

Disc Title Input:

If your CD player or MD recorder has the disc memory function, you can input the following information about the normal audio CDs or MDs on the TV screen.

- For CDs: Performer, disc title, and music genre
- For MDs: Disc title and song titles

*What is a CD Text?

In a CD Text, some information about the disc (its disc title, performer, composer, arranger, etc.) is recorded.

Notes:

- If your audio component has two COMPU LINK-3 (SYNCHRO) jacks, you can use either one. If it has only one COMPU LINK-3 (SYNCHRO) jack, connect it so that it is the last item in the series of components. (For example, the CD player in the diagram to the left.)
- If your audio component has two TEXT COMPU LINK jacks, you can use either one. If it has only one TEXT COMPU LINK jack, connect it so that it is the last item in the series of components. (For example, the CD player in the diagram to the left.)
- "TEXT COMPULINK SOURCE NOT CONNECTED" appears on the display in the following cases:
 - When the connections explained to the left are not correctly done.
 - When you try to use the TEXT COMPULINK function a few seconds after you turn on the connected equipment. This is not a malfunction of the units.
- Refer also to the manuals supplied with your CD player or MD recorder.

IMPORTANT:

If you turn on the receiver before turning on the other components after connecting the components, the TEXT COMPU LINK remote control system does not work correctly.

If this happens:

1. Turn off all the components including this receiver.
2. Turn on the connected components.
3. Turn on this receiver.

OPERATIONS

To use this remote control system, you need to connect the TV to the MONITOR OUT jack on the rear panel (see page 7), and set the TV's input mode to the proper position to which the receiver is connected. **Make sure you have connected the CD player or MD recorder equipped with the TEXT COMPU LINK remote control system. If not, you cannot use the following functions.**

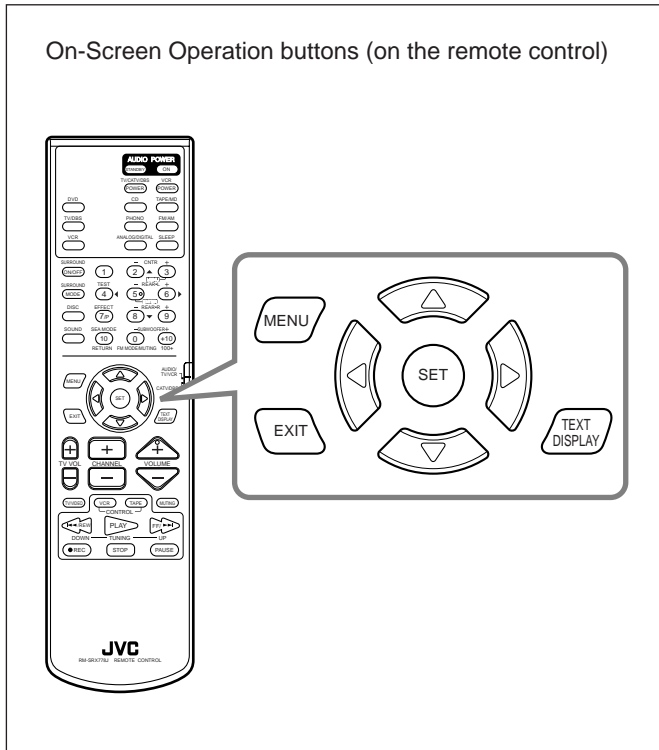

Showing the Disc Information on the TV Screen

Press **TEXT DISPLAY** while "CD" or "MD" is selected as the source.

The Disc Information screen appears on the TV.

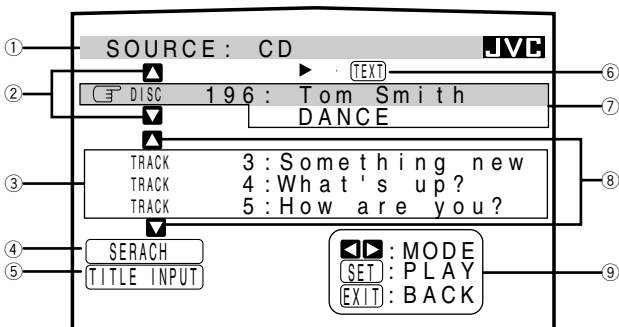

- ① Source name: CD or MD
- ② Select **▲** or **▼**, then press SET to change the disc.
- ③ Track numbers and track titles.
 - The current playing (selected) track is indicated in yellow.
 - When you move **←** to a track number, you can change the track information by pressing **◀/▶**. Each time you press the button, track information alternates between its track title and its performer. (You can also start playing the track by pressing SET.)
- ④ Select this (move **←** in front), then press SET to go to the DISC SEARCH screen (see page 36).
- ⑤ Select this (move **←** in front), then press SET to go to the TITLE INPUT screen (see page 37).
- ⑥ This appears only when a CD Text is selected.
- ⑦ Disc information such as the disc title, performer, and music genre.

When this is selected (**←** in front), you can change the disc information by pressing **◀/▶**. Each time you press the button, disc information (see "Note on ⑦") changes.
- ⑧ Select **▲** or **▼**, then press SET to change the track.
- ⑨ Usable buttons and their functions for the current selection.

Indication here will be changed according to what is currently selected (**←** in front) on the screen. See "Note on ⑨."

Note on ⑦:

The following information will appear on the display:

- For CD Text:
 - Disc title
 - Performer
 - Genre
 - Song writer
 - Composer
 - Arranger
 - Message
 - For MD: only Disc Title will appear
- Only recorded information will be shown. If there is no data, "NO DATA" will appear.

Note on ⑨:

For example, the SET button will be used to start play (PLAY), to go to the next screen (ENTER), and to determine the selection (ENTER).

To exit from the Disc information screen:

Press EXIT.

Notes:

- The on-screen display will disappear in the following case:
 - if no operation is done for about 10 minutes.
 - if you do any operation other than explained in this section.
- To control the MD recorder using the TEXT COMPU LINK remote control system, you have to change the source name shown on the display from "TAPE" to "MD." (See page 12.)
- Some special characters and marks cannot be displayed correctly.

■ Searching a for Disc (Only for the CD player)

Search for a disc by its performer:

1. Press TEXT DISPLAY while “CD” is selected as the source.

The Disc Information screen appears on the TV.

2. Press Δ / ∇ to move \leftarrow to “SEARCH,” then press SET.

The DISC SEARCH screen appears.

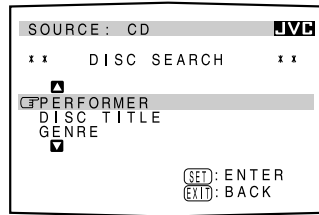

3. Press Δ / ∇ to move \leftarrow to “PERFORMER”, then press SET.

The PERFORMER SEARCH screen appears.

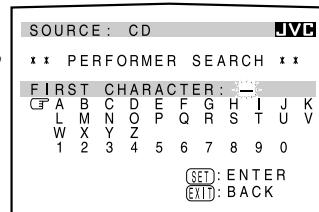

4. Press $\Delta / \nabla / \triangleleft / \triangleright$ to move \leftarrow in front of the first character of the performer you want to search, then press SET.

To correct the incorrect entry, press $\Delta / \nabla / \triangleleft / \triangleright$ to move \leftarrow in front of the correct character, then press SET.

Note:

Symbols such as @, # or \$ cannot be available for search.

5. Press SET again.

Disc search starts, then the SEARCH RESULT screen, showing the performers, appears.

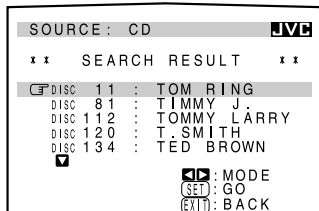

6. On the SEARCH RESULT screen, you can do the following:

- **Changing the indication of the disc information:** Press Δ / ∇ to move \leftarrow to a searched disc, then press $\triangleleft / \triangleright$. Each time you press $\triangleleft / \triangleright$, the disc information alternates between its performer and its disc title.
- **Starting a disc play and going to the Disc Information screen (see page 35):** Press Δ / ∇ to move \leftarrow to a searched disc, then press SET.
- **Showing unseen disc information (if more than 5 discs are listed as a result of the search):** Press Δ / ∇ until they appear.
- **Going back to the PERFORMER SEARCH screen:** Press EXIT.

Search for a disc by its disc title:

1. Press TEXT DISPLAY while “CD” is selected as the source.

The Disc Information screen appears on the TV.

2. Press Δ / ∇ to move \leftarrow to “SEARCH,” then press SET.

The DISC SEARCH screen appears.

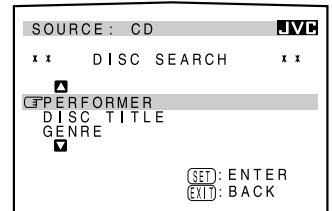

3. Press Δ / ∇ to move \leftarrow to “DISC TITLE,” then press SET.

The DISC TITLE SEARCH screen appears.

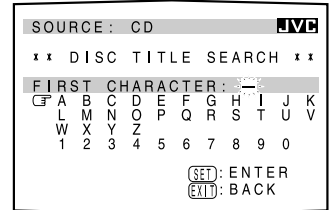

4. Press $\Delta / \nabla / \triangleleft / \triangleright$ to move \leftarrow in front of the first character of the disc title you want to search, then press SET.

To correct the incorrect entry, press $\Delta / \nabla / \triangleleft / \triangleright$ to move \leftarrow in front of the correct character, then press SET.

Note:

Symbols such as @, # or \$ cannot be available for search.

5. Press SET again.

Disc search starts, then the SEARCH RESULT screen, showing the disc titles, appears.

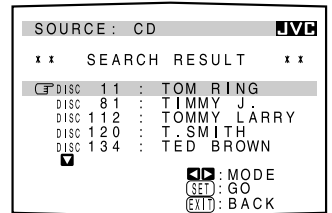

6. On the SEARCH RESULT screen, you can do the following:

- **Changing the indication of the disc information:** Press Δ / ∇ to move \leftarrow to a searched disc, then press $\triangleleft / \triangleright$. Each time you press $\triangleleft / \triangleright$, the disc information alternates between its disc title and its performer.
- **Starting a disc play and going to the Disc Information screen (see page 35):** Press Δ / ∇ to move \leftarrow to a searched disc, then press SET.
- **Showing unseen disc information (if more than 5 discs are listed as a result of the search):** Press Δ / ∇ until they appear.
- **Going back to the DISC TITLE SEARCH screen:** Press EXIT.

Search for a disc by its genre:

1. Press TEXT DISPLAY while “CD” is selected as the source.

The Disc Information screen appears on the TV.

2. Press Δ / ∇ to move \leftarrow to “SEARCH,” then press SET.

The DISC SEARCH screen appears.

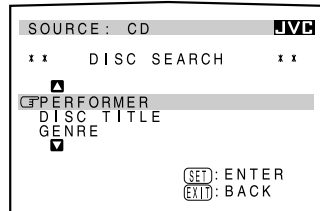

3. Press Δ / ∇ to move \leftarrow to “GENRE”, then press SET.

The GENRE SEARCH screen appears.

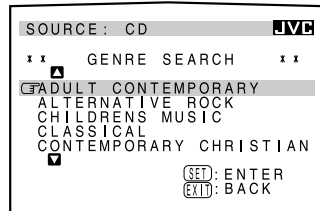

4. Press Δ / ∇ to move \leftarrow to the genre you want to search, then press SET.

To show the unseen genres, press Δ / ∇ until they appear.

Disc search starts, then the SEARCH RESULT screen, showing the disc titles, appears.

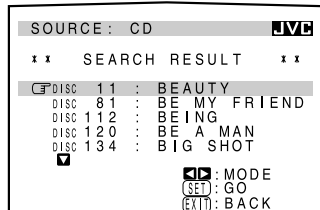

5. On the SEARCH RESULT screen, you can do the following:

- **Changing the indication of the disc information:** Press Δ / ∇ to move \leftarrow to a searched disc, then press \triangleleft / \triangleright . Each time you press \triangleleft / \triangleright , the disc information alternates between its disc title and its performer.
- **Starting a disc play and going to the Disc Information screen (see page 35):** Press Δ / ∇ to move \leftarrow to a searched disc, then press SET.
- **Showing unseen disc information (if more than 5 discs are listed as a result of the search):** Press Δ / ∇ until they appear.
- **Going back to the GENRE SEARCH screen:** Press EXIT.

Entering the Disc Information

For the CD Player with the disc memory function:

You can use the disc memory function through this receiver.

The disc information (its performer, disc title, and music genre) of normal audio CDs will be stored into the memory built in the CD player.

For the disc memory function, refer to the manual supplied with your CD player.

- The performer, disc title, and music genre information are usually recorded in a CD Text. However, if a CD Text has no genre information recorded in the disc itself, you can input its music genre by yourself.

Note:

You can enter the TITLE INPUT screens for a CD Text and input its titles. However, you cannot store the titles you have input for a CD Text.

Example: Entering the following information for Disc 1
Performer: “MICHAEL”
Disc title: “MY FAVORITE”

1. Press TEXT DISPLAY while “CD” is selected as the source.

The Disc Information screen appears on the TV.

2. Press Δ / ∇ to move \leftarrow to “TITLE INPUT,” then press SET.

The TITLE INPUT: PERFORMER screen appears.

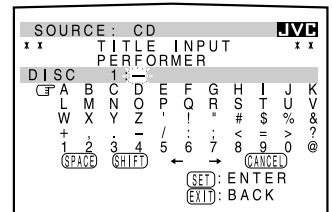

3. Press Δ / ∇ / \triangleleft / \triangleright to move \leftarrow in front of a character you want, then press SET to enter the character.

- If the current CD is a CD Text, go to step 5 without entering the performer.

To use the lower case letters, press Δ / ∇ / \triangleleft / \triangleright to move \leftarrow to (SHIFT), then press SET.

To use the upper case letters again, press Δ / ∇ / \triangleleft / \triangleright to move \leftarrow to (SHIFT), then press SET.

4. Repeat step 3 until you finish putting a performer name (up to 32 characters).

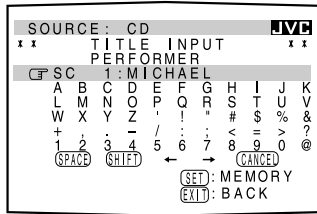

To insert a space, press Δ / ∇ / $\triangleleft / \triangleright$ to move CF to SPACE , then press SET.

To correct an incorrect character:

- 1) Press Δ / ∇ / $\triangleleft / \triangleright$ to move CF to \leftarrow or \rightarrow , then press SET until the incorrect character is selected.
- 2) Press Δ / ∇ / $\triangleleft / \triangleright$ to move CF to **CANCEL**, then press SET to erase the character.
- 3) Press Δ / ∇ / $\triangleleft / \triangleright$ to move CF in front of the correct character, then press SET to enter a correct character.

5. Press Δ / ∇ / $\triangleleft / \triangleright$ to move CF to "DISC 1: MICHAEL (in this example)," then press SET.

The TITLE INPUT: DISC TITLE screen appears.

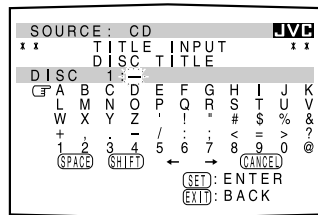

6. Enter the disc title, referring to steps 3 and 4.

- If the current CD is a CD Text, go to the next step without entering the disc title.

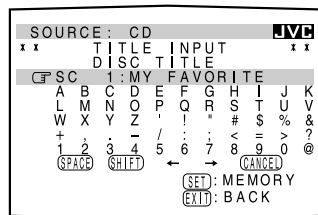

7. Press Δ / ∇ / $\triangleleft / \triangleright$ to move CF to "DISC 1: MY FAVORITE (in this example)," then press SET.

The TITLE INPUT: DISC 1 GENRE screen appears.

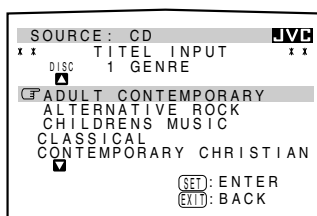

8. Press Δ / ∇ to move CF to the genre you want, then press SET.

The Disc Information screen appears again.

To show the unseen genres, press Δ / ∇ until they appear.

For the MD recorder:

You can write the disc information (disc title and song titles) into the disc. You can only write the song title for the song currently selected.

- If you have the CD-MD combination deck, you can also enter the disc information (its performer, disc title, and its music genre) of normal audio CDs into the memory built in the CD-MD combination deck. (To do this, follow the procedure of "For the CD Player with the disc memory function" to the left.)
- If you change the disc or song title with more than 32 characters, the characters following 32nd will be erased from the title.

1. Press TEXT DISPLAY while "MD" is selected as the source.

The Disc Information screen appears on the TV.

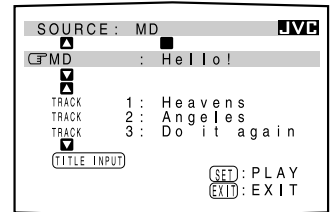

2. Press Δ / ∇ to move CF to "TITLE INPUT," then press SET.

The DISC TITLE INPUT screen appears.

3. Enter the title, referring to steps 3 and 4 of "For the CD Player with the disc memory function" to the left.

- You can enter up to 32 characters for the disc title.

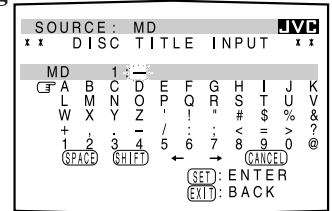

4. Press Δ / ∇ / $\triangleleft / \triangleright$ to move CF to the disc title you have just entered, then press SET.

The disc title is stored into the memory, and the SONG TITLE INPUT screen for the currently selected song appears.

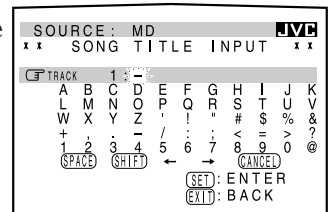

- You can enter a song title for the song currently selected (indicated in yellow on the TV screen).

5. Enter the song title, referring to steps 3 and 4 of "For the CD Player with the disc memory function" to the left.

- You can enter up to 32 characters for the song title.

6. Press Δ / ∇ / $\triangleleft / \triangleright$ to move CF to the song title you have just entered, then press SET.

The song title is stored into the memory, and the Disc Information screen appears again.

AV COMPU LINK Remote Control System

The AV COMPU LINK remote control system allows you to operate JVC video components (TV, VCR, and DVD player) through the receiver.

To use this remote control system, you need to connect the video components you want to operate, follow the diagrams below and the procedure on the next page.

CONNECTIONS 1:

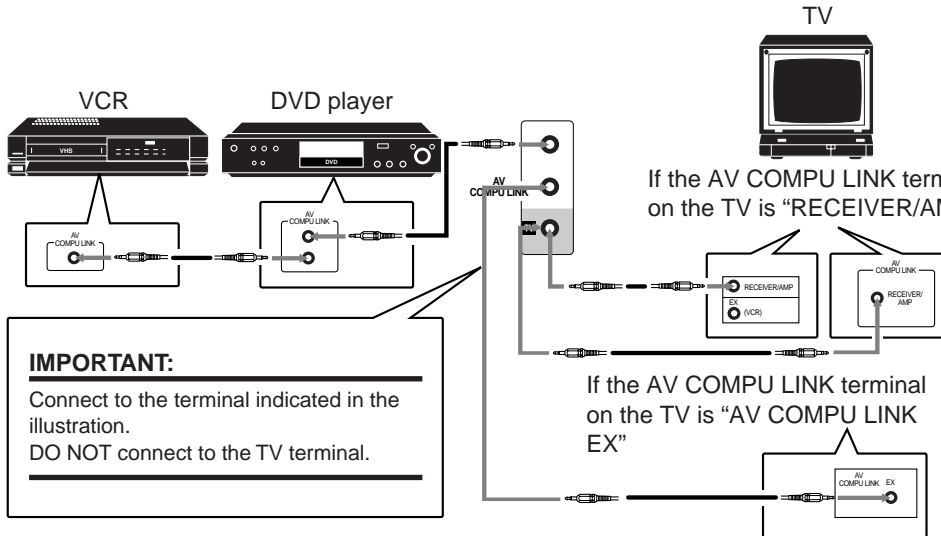

IMPORTANT:

Connect to the terminal indicated in the illustration.
DO NOT connect to the TV terminal.

CAUTION:

The AV COMPU LINK remote control system cannot control the DBS tuner connected to the TV SOUND/DBS jacks.

Notes:

- When connecting only the VCR or DVD player to this receiver, connect it directly to the receiver using cable with the monaural mini-plugs.
- Refer also to the manual supplied with your video components.

CONNECTIONS 2:

CASE1: If the DVD player is equipped with the S-video terminals

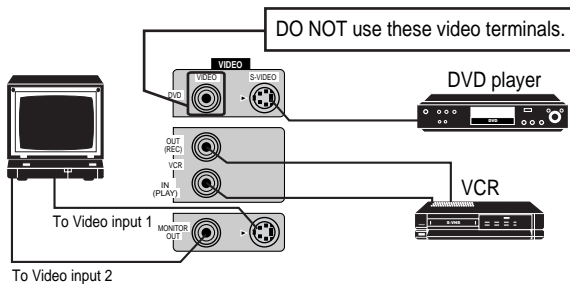

CASE2: If the DVD player is not equipped with the S-video terminals

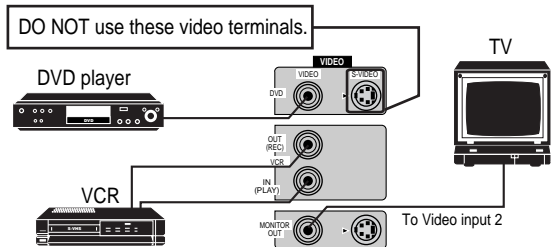

1. **If you have already plugged your VCR, DVD player, TV, and this receiver into the AC outlets, unplug their AC power cords first.**
2. **Connect your VCR, DVD player, TV, and this receiver, using the cables with the monaural mini-plugs (not supplied).**
 - See “CONNECTIONS 1” on the previous page.
3. **Connect the audio input/output jacks on VCR, DVD player, TV, and this receiver using the cables with RCA pin plug**
 - See page 7.
4. **Connect the video input/output jacks on VCR, DVD player, TV, and this receiver, using the cables with RCA pin plug or with S-video plug.**
 - See “CONNECTIONS 2” on the previous page.
5. **Plug the AC power cords of the components into the AC outlets.**
6. **When turning on the TV for the first time after the AV COMPU LINK connection, turn the TV volume to the minimum using the TV volume control on the TV.**
7. **Turn on the other connected components first, then turn on this receiver.**
 - When turning on the VCR, use the remote control supplied with this receiver (press VCR POWER).

The AV COMPU LINK remote control system allows you to use the five basic functions listed below.

Remote Control of the TV, DVD player, and VCR Using This Remote Control

See page 42 for details.

For the DVD player and the VCR:

- Aim the remote control directly at the remote sensor on each component.

For the TV having AV COMPU LINK terminal “RECEIVER/AMP”:

- Aim the remote control directly at the remote sensor on the receiver when operating the TV.

For the TV having AV COMPU LINK terminal “AV COMPU LINK EX”:

- Aim the remote control directly at the remote sensor on the TV when operating the TV.

One-Touch Video Play

Simply by inserting a video cassette without its safety tab into the VCR, you can enjoy the video playback without setting other switches manually. The receiver automatically turns on and changes the source to “VCR.”

The TV automatically turns on and changes the input mode to the position so that you can view the playback picture.

When you insert a video cassette with its safety tab, press the play (▶) button on the VCR or on the remote control. So, you can get the same result.

One-Touch DVD Play

Simply by starting playback on the DVD player, you can enjoy the DVD playback without setting other switches manually.

- When the DVD player is connected through the analog input jacks on this receiver (and analog input is selected), the receiver automatically turns on and changes the source to “DVD.”
- When the DVD player is connected through the digital input terminal on this receiver (and digital input is selected), the receiver automatically turns on and changes the source to “DVD DIGITAL.”

The TV automatically turns on and changes the input mode to the position so that you can view the playback picture.

Automatic Selection of TV's Input Mode

- When you select “TV SOUND” as the source to play on the receiver, the TV automatically changes the input mode to the TV tuner so that you can watch TV.
- When you select “DVD” (or “DVD DIGITAL”), “VCR,” or “DBS” (or “DBS DIGITAL”) as the source to play on the receiver, the TV automatically changes the input mode to the appropriate position (either Video Input 1 or Video Input 2) so that you can view the playback picture.

Note:

When you select “TV SOUND” as the source on the receiver, you cannot see the menu on the TV screen since the AV COMPU LINK remote control system automatically changes the TV's input mode to the TV tuner.

If you do not mind stopping listening to the TV sounds, you can then show the on-screen displays after changing the TV's input mode to the appropriate position (either Video Input 1 or Video Input 2) the receiver is connected to.

Automatic Power On/Off

The TV, VCR, and DVD player turn on and off along with the receiver.

When you turn on the receiver;

- If the previously selected source is “VCR,” the TV and VCR will turn on automatically.
- If the previously selected source is “TV SOUND” or “DBS” (or “DBS DIGITAL”), only the TV will turn on automatically.
- If the previously selected source is “DVD” (or “DVD DIGITAL”), the TV and DVD player will turn on automatically.

When you turn off the receiver, the TV, VCR and the DVD player will turn off.

Note:

If you turn off the receiver while recording on the VCR, the VCR will not turn off, but continue recording.

Operating JVC's Audio/Video Components

You can operate JVC's audio and video components with this receiver's remote control, since control signals for JVC components are preset in the remote control.

IMPORTANT:

To operate JVC's audio components using this remote control:

- You need to connect JVC audio components through the COMPU LINK-3 (SYNCHRO) jacks (see page 33) in addition to the connections using cables with RCA pin plugs (see page 6).
- Aim the remote control directly at the remote sensor on the receiver.
- If you use the buttons on the front panel or the menu function to choose a source, the remote control will not operate that source. To operate a source with the remote control, the source must be selected using source selecting buttons on the remote control.
- To operate the cassette deck or MD recorder using the COMPU LINK remote control system, set the source name correctly. (See page 12.)
- Refer also to the manuals supplied with your components.

Sound control section (Amplifier)

You can always perform the following operations (with the remote control mode selector set to "AUDIO/TV/VCR"):

- SURROUND ON/OFF: Turns on or off the Surround modes – Dolby Pro Logic and Dolby Digital.
- SURROUND MODE: Selects the DSP modes.

After pressing SOUND (with the remote control mode selector set to "AUDIO/TV/VCR"), you can perform the following operations:

- SEA MODE: Changes the SEA modes.
- SUBWOOFER – / +: Adjusts the subwoofer output level.
- CNTR – / +: Adjusts the center speaker output level.
- REAR•L – / +: Adjusts the left rear speaker output level.
- REAR•R – / +: Adjusts the right rear speaker output level.
- EFFECT: Selects the effect level.
- TEST: Turns on or off the test tone output.

Note:

After adjusting sounds, press the corresponding source selecting button or DISC to operate your target source by using the 10 keys; otherwise, the 10 keys cannot be used for operating your target source.

CD player

After pressing CD (with the remote control mode selector set to "AUDIO/TV/VCR"), you can perform the following operations on the CD player:

- PLAY: Starts playing.
- ◀◀: Returns to the beginning of the current (or previous) track.
- ▶▶: Skips to the beginning of the next track.
- STOP: Stops playing.
- PAUSE: Pauses playing. To release it, press PLAY.
- 1 – 10, +10: Selects a track number directly.
For track number 5, press 5.
For track number 15, press +10, then 5.
For track number 20, press +10, then 10.
For track number 30, press +10, +10, then 10.

CD player-changer

After pressing DISC (with the remote control mode selector set to "AUDIO/TV/VCR"), you can perform the following operations on a CD player-changer:

- PLAY: Starts playing.
- ◀◀: Returns to the beginning of the current (or previous) track.
- ▶▶: Skips to the beginning of the next track.
- STOP: Stops playing.
- PAUSE: Pauses playing. To release it, press PLAY.
- 1 – 6, 7/P: Select the number of a disc installed in a CD player-changer.

After pressing CD (with the remote control mode selector set to "AUDIO/TV/VCR"), you can perform the following operations on the CD player-changer:

- 1 – 10, +10: Selects a track number directly.
For track number 5, press 5.
For track number 15, press +10, then 5.
For track number 20, press +10, then 10.
For track number 30, press +10, +10, then 10.

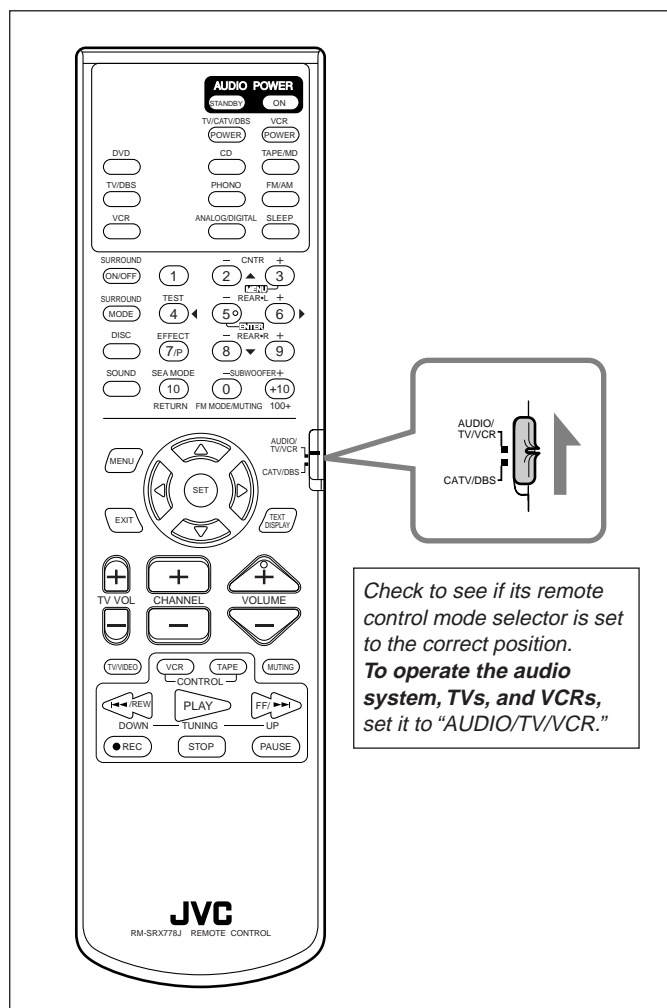

Tuner

After pressing FM/AM (with the remote control mode selector set to "AUDIO/TV/VCR"), you can perform the following operations:

- FM/AM: Alternates between FM and AM.
- 1 – 10, +10: Selects a preset channel number directly.
For channel number 5, press 5.
For channel number 15, press +10, then 5.
For channel number 20, press +10, then 10.
- TUNING UP/TUNING DOWN: Tunes into stations.
- FM MODE/MUTING: Changes the FM reception mode.

Turntable

After pressing PHONO (with the remote control mode selector set to "AUDIO/TV/VCR"), you can perform the following operations on a turntable:

PLAY: Starts playing.
STOP: Stops operations.

Cassette deck

After pressing TAPE/MD or TAPE CONTROL (with the remote control mode selector set to "AUDIO/TV/VCR"), you can perform the following operations on a cassette deck:

PLAY: Starts playing.
◀◀: Fast winds the tape from right to left.
▶▶: Fast winds the tape from left to right.
STOP: Stops operations.
PAUSE: Pauses playing. To release it, press PLAY.
● REC: Press this button with the PLAY button to start recording.
Press this button with the PAUSE button to enter recording pause.

MD recorder

After pressing TAPE/MD or TAPE CONTROL (with the remote control mode selector set to "AUDIO/TV/VCR"), you can perform the following operations on the MD recorder:

PLAY: Starts playing.
◀◀: Returns to the beginning of the current (or previous) track.
▶▶: Skips to the beginning of the next track.
STOP: Stops playing.
PAUSE: Pauses playing. To release it, press PLAY.
● REC: Press this button with the PLAY button to start recording.
Press this button with the PAUSE button to enter recording pause.

Note:

You can use either TAPE/MD button or the TAPE CONTROL button to activate the buttons listed above. If you press TAPE/MD, the playing source also changes. On the other hand, if you press TAPE CONTROL, the playing source does not change.

IMPORTANT:

To operate JVC's video components using this remote control:

- You need to connect JVC video components through the AV COMPU LINK terminals (see page 39) in addition to the connections using cables with RCA pin plugs (see page 7).
- Some JVC VCRs can accept two types of the control signals — remote code "A" and "B." Before using this remote control, make sure that the remote control code of the VCR connected to the VCR jacks is set to code "A."
- When using the remote control:
 - For the DVD player and VCR operations, aim the remote control directly at the remote sensor on each component, not on the receiver.
 - For the TV operations:
 - If the TV having the AV COMPU LINK terminal "RECEIVER/AMP," aim the remote control directly at the remote sensor on the receiver.
 - If the TV having the AV COMPU LINK terminal "AV COMPU LINK EX," aim the remote control directly at the remote sensor on the TV.

VCR

You can always perform the following operations (with the remote control mode selector set to "AUDIO/TV/VCR"):

VCR POWER: Turns on or off the VCR.

After pressing VCR or VCR CONTROL (with the remote control mode selector set to "AUDIO/TV/VCR"), you can perform the following operations on the VCR:

1 – 9, 0: Selects the TV channels on VCR.
PLAY: Starts playing.
◀◀: Rewinds a tape.
▶▶: Fast winds a tape.
STOP: Stops operations.
PAUSE: Pauses playing. To release it, press PLAY.
● REC: Press this button with the PLAY button to start recording.
Press this button with the PAUSE button to enter recording pause.
CHANNEL +/-: Changes the TV channels on the VCR.

Note:

You can use either VCR button or the VCR CONTROL button to activate the buttons listed above. If you press VCR, the playing source also changes. On the other hand, if you press VCR CONTROL, the playing source does not change.

DVD player

After pressing DVD (with the remote control mode selector set to "AUDIO/TV/VCR"), you can perform the following operations on a DVD player:

PLAY: Starts playing.
◀◀: Returns to the beginning of the current (or previous) track.
▶▶: Skips to the beginning of the next track.
STOP: Stops playing.
PAUSE: Stops playing temporarily. To release it, press PLAY.

After pressing DVD, these buttons can be used for the DVD menu operations.

Note:

For detailed menu operations, refer to the instructions supplied with the discs or the DVD player.

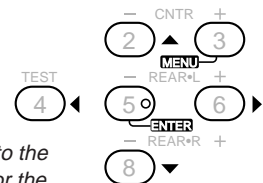

TV

You can always perform the following operations (with the remote control mode selector set to "AUDIO/TV/VCR"):

TV/CATV/DBS POWER: Turns on or off the TV.
TV VOL +/-: Adjusts the volume.
TV/VIDEO: Sets the input mode (either TV or VIDEO).

After pressing TV/DBS (with the remote control mode selector set to "AUDIO/TV/VCR"), you can perform the following operations on a TV:

CHANNEL +/-: Changes the channels.
1 – 9, 0, 100+: Selects the channels.
RETURN: Alternates between the previously selected channel and the current channel.

Operating Other Manufacturers' Video Equipment

This remote control supplied with the receiver can transmit control signals for other manufacturers' VCRs, TVs, CATV converters and DBS tuners. By changing the transmittable signals from preset ones to the other manufacturers', you can operate the other manufacturer's components using this remote control.

When operating the other manufacturers' components, refer also to the manuals supplied with them. To operate these components with the remote control, first you need to set the manufacturer's code each for VCR, TV, CATV converters, and DBS tuner.

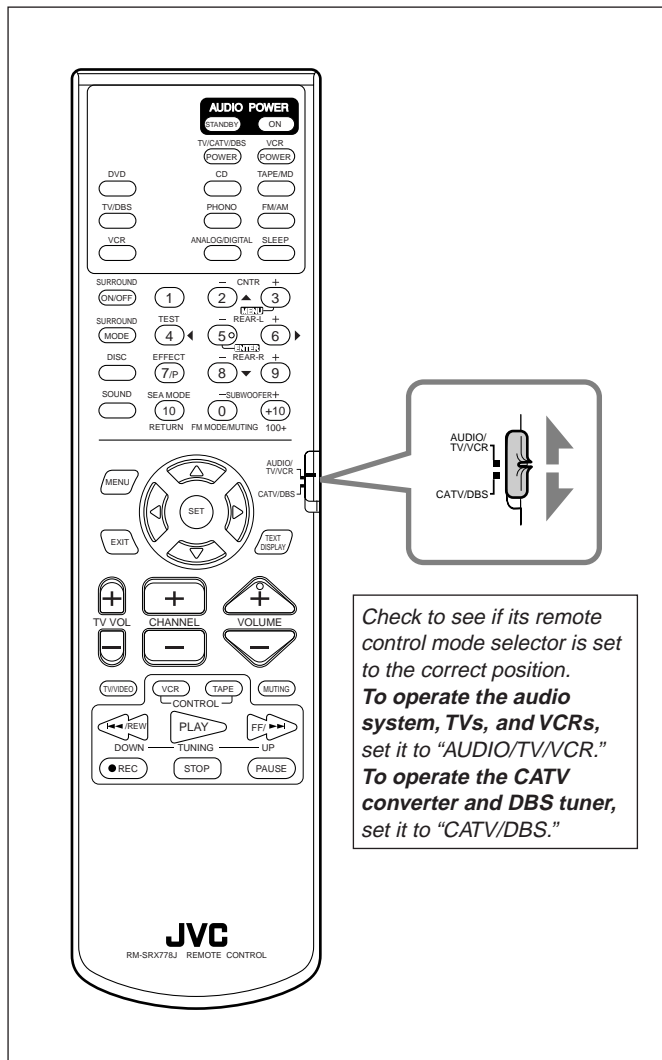

To change the transmittable signals for operating another manufacturer's TV

1. Set the remote control mode to "AUDIO/TV/VCR."
2. Press and hold TV/CATV/DBS POWER.
3. Press TV/DBS.
4. Enter manufacturer's code (two digits) using buttons 1-9, and 0.

See the list below.

Examples: For a JVC product, press 0, then 1.
For a Hitachi product, press 1, then 0.

5. Release TV/CATV/DBS POWER.

The following buttons can be used for operating the TV (with the remote control mode selector set to "AUDIO/TV/VCR"):

TV/CATV/DBS POWER

Turns on and off the TV.

TV VOL +/- Adjusts the volume.

TV/VIDEO Sets the input mode (either TV or VIDEO).

After pressing TV/DBS (with the remote control mode selector set to "AUDIO/TV/VCR"), you can perform the following operations on a TV:

CHANNEL +/- Changes the channels.

1 - 10, 0, 100+ (+10) Selects the channels.
100+ (+10) button will function as the ENTER button if your TV requires pressing ENTER after selecting a channel number.

Note:

Refer to the manual supplied with your TV.

6. Try to operate your TV by pressing TV/CATV/DBS POWER.

When your TV turns on or off, you have entered the correct code.

If there are more than one code listed for your brand of TV, try each one until the correct one is entered.

| Manufacturer | Code | Manufacturer | Code |
|--------------|--------|--------------|------|
| JVC | 01 | SAMSUNG | 12 |
| HITACHI | 10 | SANYO | 13 |
| MAGNAVOX | 02 | SHARP | 06 |
| MITSUBISHI | 03 | SONY | 07 |
| PANASONIC | 04, 11 | TOSHIBA | 08 |
| RCA | 05 | ZENITH | 09 |

Manufacturers' codes are subject to change without notice. If they are changed, this remote control cannot operate the equipment.

To change the transmittable signals for operating a CATV converter or DBS tuner

1. Set the remote control mode to “CATV/DBS.”
2. Press and hold TV/CATV/DBS POWER.
3. Press TV/DBS.
4. Enter manufacturer’s code (three digits) using buttons 1–9, and 0.

See the list below.

Examples: For a Pioneer product, press 1, then 3.
For a Sony product, press 2, then 0.

5. Release TV/CATV/DBS POWER.

After setting the remote control mode selector to “CATV/DBS,” you can perform the following operations on the CATV converter or on the DBS tuner:

- TV/CATV/DBS POWER Turns on and off the CATV converter or DBS tuner.
- CHANNEL +/- Changes the channels.
1 – 10, 0, 100+ (+10) Selects the channel.
100+ (+10) button will function as the ENTER button if your equipment requires pressing ENTER after selecting a channel number.

Note:

Refer to the manual supplied with your CATV converter or DBS tuner.

6. Try to operate your CATV converter or DBS tuner by pressing TV/CATV/DBS POWER.

When your CATV converter or DBS tuner turns on or off, you have entered the correct code.

If there are more than one code listed for your brand of CATV converter or DBS tuner, try each one until the correct one is entered.

| Manufacturer | Codes |
|--------------------|--------------------------------|
| GI/JERROLD | 01, 02, 03, 04, 05, 06, 07, 08 |
| HAMLIN/REGAL | 15, 16, 17, 18 |
| PIONEER | 13, 14 |
| RCA | 19 |
| SCIENTIFIC ATLANTA | 09, 10 |
| SONY | 20 |
| ZENITH | 11, 12 |

Manufacturers’ codes are subject to change without notice. If they are changed, this remote control cannot operate the equipment.

To change the transmittable signals for operating another manufacturer’s VCR

1. Set the remote control mode to “AUDIO/TV/VCR.”
2. Press and hold VCR POWER.

3. Press VCR.

4. Enter manufacturer’s code (two digits) using buttons 1–9, and 0.

See the list below.

Examples: For a JVC product, press 0, then 1.
For a Funai product, press 1, then 0.

5. Release VCR POWER.

Following button can be used for operating the VCR (with the remote control mode selector set to “AUDIO/TV/VCR”):

VCR POWER Turns on and off the VCR.

After pressing VCR or VCR CONTROL (with the remote control mode selector set to “AUDIO/TV/VCR”), you can perform the following operations on the VCR:

- CHANNEL +/- Changes the TV channels on the VCR.
1 – 10, 0, 100+ (+10) Selects the TV channels.
100+ (+10) button will function as the ENTER button if your VCR requires pressing ENTER after selecting a channel number.
- PLAY Starts playback.
- ◀◀ Rewinds a video tape.
- ▶▶ Fast winds a video tape.
- STOP Stops operation.
- PAUSE Pauses.
- REC: Starts recording or enters recording pause.

Notes:

- Refer to the manual supplied with your VCR.
- You can use either VCR button or the VCR CONTROL button to activate the buttons listed above. If you press VCR, the playing source also changes. On the other hand, if you press VCR CONTROL, the playing source does not change.

6. Try to operate your VCR by pressing VCR POWER.

When your VCR turns on or off, you have entered the correct code.

If there are more than one code listed for your brand of VCR, try each one until the correct one is entered.

| Manufacturer | Codes | Manufacturer | Codes |
|--------------|----------------|--------------|------------|
| JVC | 01, 02, 03 | PHILIPS | 09 |
| EMERSON | 11, 26 | RCA | 05, 06 |
| FISHER | 29 | SAMSUNG | 24 |
| FUNAI | 10, 14, 15, 16 | SANYO | 21, 22, 23 |
| GOLD STAR | 12 | SHARP | 27, 28 |
| HITACHI | 04 | SHINTOM | 30 |
| MITSUBISHI | 13 | SONY | 18, 19, 20 |
| NEC | 25 | TOSHIBA | 26 |
| PANASONIC | 07, 17 | ZENITH | 08 |

Manufacturers’ codes are subject to change without notice. If they are changed, this remote control cannot operate the equipment.

Troubleshooting

Use this chart to help you solve daily operational problems. If there is any problem you cannot solve, contact your JVC service center.

| PROBLEM | POSSIBLE CAUSE | SOLUTION |
|---|--|--|
| The display does not light up. | The power cord is not plugged in. | Plug the power cord into an AC outlet. |
| No sound from speakers. | Speaker signal cables are not connected. | Check speaker wiring and reconnect if necessary. |
| | The SPEAKERS 1 and 2 buttons are not set correctly. | Press SPEAKERS 1 and 2 correctly. |
| | An incorrect source is selected. | Select the correct source. |
| | Muting is activated. | Press MUTING to cancel the mute. |
| Sound from one speaker only. | Speaker signal cables are not connected properly. | Check speaker wiring and reconnect if necessary. |
| | The balance is set to one extreme. | Adjust the balance properly (see page 12). |
| Continuous hiss or buzzing during FM reception. | Incoming signal is too weak. | Connect an outside FM antenna or contact your dealer. |
| | The station is too far away. | Select a new station. |
| | An incorrect antenna is used. | Check with your dealer to be sure you have the correct antenna. |
| | Antennas are not connected properly. | Check connections. |
| Occasional cracking noise during FM reception. | Ignition noise from automobiles. | Move the antenna farther from automobile traffic. |
| No colors on the on-screen display. | The color system of the connected TV is not NTSC. | Connect an NTSC TV. |
| Howling during record playing. | Your turntable is too close to speakers. | Move speakers away from the turntable. |
| "OVERLOAD" starts flashing on the display. | Speakers are overloaded because of high volume. | Rotate the MASTER VOLUME control counterclockwise three or four times, then press POWER on the front panel. If "OVERLOAD" does not disappear, unplug the AC power cord, then plug it back again. |
| | Speakers are overloaded because of short circuit of speaker terminals. | Press POWER on the front panel, then check the speaker wiring. If "OVERLOAD" does not disappear, unplug the AC power cord, then plug it back again. If speaker wiring is not short-circuited, contact your dealer. |
| Remote control does not work. | The remote control mode selector is not set correctly. | Set the selector correctly either to "AUDIO/TV/VCR" or to "CATV/DBS." |
| | There is an obstruction in front of the remote sensor on the receiver. | Remove the obstruction. |
| | Batteries are weak. | Replace batteries. |

Specifications

Amplifier

Output Power

At Stereo operation:

Front channels: **110 watts per channel, min. RMS, driven into 8 ohms, 20 Hz to 20 kHz with no more than 0.06% total harmonic distortion.**

At Surround operation:

Front channels: 100 watts per channel, min. RMS, driven into 8 ohms at 1 kHz with no more than 0.8% total harmonic distortion.

Center channel: 100 watts, min. RMS, driven into 8 ohms at 1 kHz, with no more than 0.8% total harmonic distortion.

Rear channels 100 watts per channel, min. RMS, driven into 8 ohms at 1 kHz, with no more than 0.8% total harmonic distortion.

Audio

Audio Input Sensitivity/Impedance (1 kHz): PHONO (MM): 2.5 mV/47 k ohms
CD, TAPE/MD, TV SOUND/DBS, VCR, DVD: 200 mV/47 k ohms

Audio Input (DIGITAL IN)*: Optical: DIGITAL 1 (DVD), DIGITAL 2 (CD): -21 dBm to -15 dBm (660 nm \pm 30 nm)
* Corresponding to Linear PCM and Dolby Digital (with sampling frequency — 32 kHz, 44.1 kHz, 48 kHz).

Audio Output Level: TAPE/MD, VCR: 200 mV

Signal-to-Noise Ratio ('66 IHF/'78 IHF): PHONO: 70 dB/78 dB (at REC OUT)
CD, TAPE/MD, TV SOUND/DBS, VCR, DVD: 87 dB/80 dB

Frequency Response (8 ohms) PHONO: 20 Hz to 20 kHz (\pm 1 dB)
CD, TAPE/MD, TV SOUND/DBS, VCR, DVD: 20 Hz to 20 kHz (\pm 1 dB)

RIAA Phono Equalization: \pm 1.0 dB (20 Hz to 20 kHz)

Loudness Control (Volume Control at -30 dB): +6 \pm 1.0 dB at 100 Hz
+4 \pm 1.0 dB at 10 kHz

SEA: Center frequencies: 100 Hz, 1 kHz, 10 kHz
Control range: \pm 10 dB \pm 2 dB

Video

Video Input Sensitivity/Impedance:
Composite video: TV SOUND/DBS, VCR, DVD: 1 V_{p-p}/75 ohms
S-video: DVD: (Y: luminance): 1 V_{p-p}/75 ohms
(C: chrominance, burst): 0.286 V_{p-p}/75 ohms

Video Output Level:
Composite video: VCR, MONITOR OUT: 1 V_{p-p}/75 ohms
S-video: MONITOR OUT: (Y: luminance): 1 V_{p-p}/75 ohms
(C: chrominance, burst): 0.286 V_{p-p}/75 ohms

Synchronization: Negative

Signal-to-Noise Ratio: 45 dB

On-Screen Color System: NTSC

FM tuner (IHF)

| | | |
|---|-----------------------------------|---------------------------------|
| Tuning Range: | 87.5 MHz to 108.0 MHz | |
| Usable Sensitivity: | Monaural: | 17.0 dBf (1.95 μ V/75 ohms) |
| 50 dB Quieting Sensitivity: | Monaural: | 21.3 dBf (3.2 μ V/75 ohms) |
| | Stereo: | 41.3 dBf (31.5 μ V/75 ohms) |
| Signal-to-Noise Ratio (IHF-A weighted): | Monaural: | 78 dB at 85 dBf |
| | Stereo: | 73 dB at 85 dBf |
| Total Harmonic Distortion: | Monaural: | 0.4% at 1 kHz |
| | Stereo: | 0.6% at 1 kHz |
| Stereo Separation at REC OUT: | 35 dB at 1 kHz | |
| Alternate Channel Selectivity: | 45 dB: (\pm 400 kHz) | |
| Frequency Response: | 30 Hz to 15 kHz: (+0.5 dB, -3 dB) | |

AM tuner

| | | |
|-----------------------|----------------------|---------------|
| Tuning Range: | 530 kHz to 1,710 kHz | |
| Usable Sensitivity: | Loop antenna | 400 μ V/m |
| Signal-to-Noise Ratio | 50 dB (100 mV/m) | |

General

| | | |
|-------------------------|--|--|
| Power Requirements: | AC 120V \sim , 60 Hz | |
| Power Consumption: | 320 watts/420 VA (at operation) | |
| | 2 watts (in standby mode) | |
| Dimensions (W x H x D): | 435 x 157 x 412.5 mm | |
| | (17 ³ / ₁₆ x 6 ³ / ₁₆ x 16 ¹ / ₄ inches) | |
| Mass: | 11.3 kg (25.0 lbs) | |

Designs & specifications are subject to change without notice.

HOW TO LOCATE YOUR JVC SERVICE CENTER

TOLL FREE : 1-800-537-5722

<http://www.jvcservice.com>

Dear customer:

In order to receive the most satisfaction from your purchase, read the instruction booklet before operating the unit. In the event that repair is necessary, or for the address nearest your location, please refer to the factory service center list below or within the Continental United States, Call 1-800-537-5722 for your authorized servicer. Remember to retain your Bill of Sale for Warranty Service.

—JVC

JVC SERVICE & ENGINEERING COMPANY OF AMERICA DIVISION OF JVC AMERICAS CORP.

FACTORY SERVICE CENTER LOCATIONS

107 Little Falls Road
Fairfield, NJ 07004-2105
(973) 808-9279

1500 Lakes Parkway
Lawrenceville, GA 30243-5857
(770) 339-2522

705 Enterprise Street
Aurora, IL 60504-8149
(630) 851-7855

5665 Corporate Avenue
Cypress, CA 90630-0024
(714) 229-8011

2969 Mapunapuna Place
Honolulu, HI 96819-2040
(808) 833-5828

10700 Hammerly, Suite 110
Houston, TX 77043
(713) 935-9331

13 Cummings Park
Woburn, MA 01801
(781) 376-9100

8192 State Road 84
Davie, FL 33324
(954) 472-1960

890 Dubuque Avenue
South San Francisco, CA 94080-1804
(650) 871-2666

Sophisticated electronic products may require occasional service. Just as quality is a keyword in the engineering and production of the wide array of JVC products, service is the key to maintaining the high level of performance for which JVC is world famous. The JVC service and engineering organization stands behind our products.

NATIONAL HEADQUARTERS
JVC SERVICE & ENGINEERING COMPANY OF AMERICA
DIVISION OF JVC AMERICAS CORP.
1700 Valley Road
Wayne, NJ 07470

If you ship the product •••

Pack your JVC unit in the original carton or one of equivalent size and strength. Enclose, with the unit, a letter stating the problem or symptom that exists and also a copy of the receipt or bill of sale you received when you purchased your JVC unit. Print your home return address on the outside and the inside of the carton. Send to the appropriate JVC Factory Service Center as listed above.

Don't service it yourself.

CAUTION

To prevent electrical shock, do not open the cabinet. No user serviceable parts inside.
Refer servicing to qualified service personnel.

ACCESSORIES

To purchase accessories for your JVC product, you may contact your local JVC Dealer.
Or from the 48 Continental United States call toll free : 800-882-2345



LIMITED WARRANTY AUDIO-2

JVC COMPANY OF AMERICA warrants this product and all parts thereof, except as set forth below ONLY TO THE ORIGINAL PURCHASER AT RETAIL to be FREE FROM DEFECTIVE MATERIAL AND WORKMANSHIP from the date of original retail purchase for the period as shown below. ("The Warranty Period.")

| | |
|-------|-------|
| PARTS | LABOR |
| 2YR | 2YR |

THIS LIMITED WARRANTY IS VALID ONLY IN THE FIFTY(50) UNITED STATES, THE DISTRICT OF COLUMBIA AND IN COMMONWEALTH OF PUERTO RICO.

WHAT WE WILL DO:

If this product is found to be defective, JVC will repair or replace defective parts at no charge to the original owner. Such repair and replacement services shall be rendered by JVC during normal business hours at JVC authorized service centers. Parts used for replacement are warranted only for the remainder of the Warranty Period. All products and parts thereof may be brought to a JVC authorized service center on a carry-in basis except for Television sets having a screen size 25 inches and above which are covered on an in-home basis.

WHAT YOU MUST DO FOR WARRANTY SERVICE:

Return your product to a JVC authorized service center with a copy of your bill of sale. For your nearest JVC authorized service center, please call toll free: (800)537-5722. If service is not available locally, box the product carefully, preferably in the original carton, and ship, insured, with a copy of your bill of sale plus and letter of explanation of the problem to the nearest JVC Factory Service Center, the name and location of which will be given to you by the toll-free number. If you have any questions concerning your JVC Product, please contact our Customer Relations Department.

WHAT IS NOT COVERED:

- This limited warranty provided by JVC does not cover:
1. Products which have been subject to abuse, accident, alteration, modification, tampering, negligence, misuse, faulty installation, lack of reasonable care, or if repaired or serviced by anyone other than a service facility authorized by JVC to render such service, or if affixed to any attachment not provided with the products, or if the model or serial number has been altered, tampered with, defaced or removed;
 2. Initial installation and installation and removal for repair;
 3. Operational adjustments covered in the Owner's Manual, normal maintenance, video and audio head cleaning;
 4. Damage that occurs in shipment, due to act of God, and cosmetic damage;
 5. Signal reception problems and failures due to line power surge;
 6. Video Pick-up Tubes/CCD Image Sensor, Cartridge, Stylus(Needle) are covered for 90 days from the date of purchase;
 7. Accessories;
 8. Batteries (except the Rechargeable Batteries are covered for 90 days from the date of purchase);

There are no express warranties except as listed above.

THE DURATION OF ANY IMPLIED WARRANTIES, INCLUDING THE IMPLIED WARRANTY OF MERCHANTABILITY, IS LIMITED TO THE DURATION OF THE EXPRESS WARRANTY HEREIN.

JVC SHALL NOT BE LIABLE FOR THE LOSS OF USE OF THE PRODUCT, INCONVENIENCE, LOSS OR ANY OTHER DAMAGES, WHETHER DIRECT, INCIDENTAL OR CONSEQUENTIAL (INCLUDING, WITHOUT LIMITATION, DAMAGE TO TAPES, RECORDS OR DISCS) RESULTING FROM THE USE OF THIS PRODUCT, OR ARISING OUT OF ANY BREACH OF THIS WARRANTY. ALL EXPRESS AND IMPLIED WARRANTIES, INCLUDING THE WARRANTIES OF MERCHANTABILITY AND FITNESS FOR PARTICULAR PURPOSE, ARE LIMITED TO THE WARRANTY PERIOD SET FORTH ABOVE.

Some states do not allow the exclusion of incidental or consequential damages or limitations on how long an implied warranty last, so these limitations or exclusions may not apply to you. This warranty gives you specific legal rights and you may also have other rights which vary from state to state.

JVC COMPANY OF AMERICA
DIVISION OF JVC AMERICAS CORP.

1700 Valley Road
Wayne, NJ 07470

REFURBISHED PRODUCTS CARRY A SEPARATE WARRANTY, THIS WARRANTY DOES NOT APPLY. FOR DETAILS OF REFURBISHED PRODUCT WARRANTY, PLEASE REFER TO THE REFURBISHED PRODUCT WARRANTY INFORMATION PACKAGED WITH EACH REFURBISHED PRODUCT.

For customer use:

Enter below the Model No. and Serial No. which is located either on the rear, bottom or side of the cabinet. Retain this information for future reference.

Model No.: _____

Serial No.: _____

Purchase date: _____

Name of dealer: _____

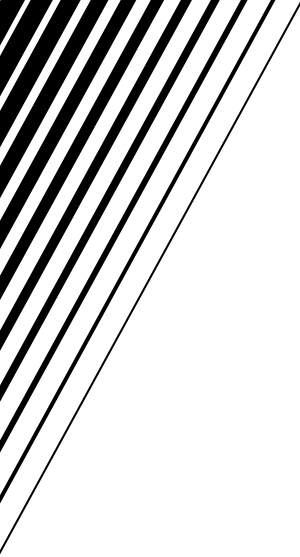

JVC
VICTOR COMPANY OF JAPAN, LIMITED