

# JVC



## COMPACT COMPONENT SYSTEM

# FS-H300

—Consists of CA-FSH300 and SP-FSH300

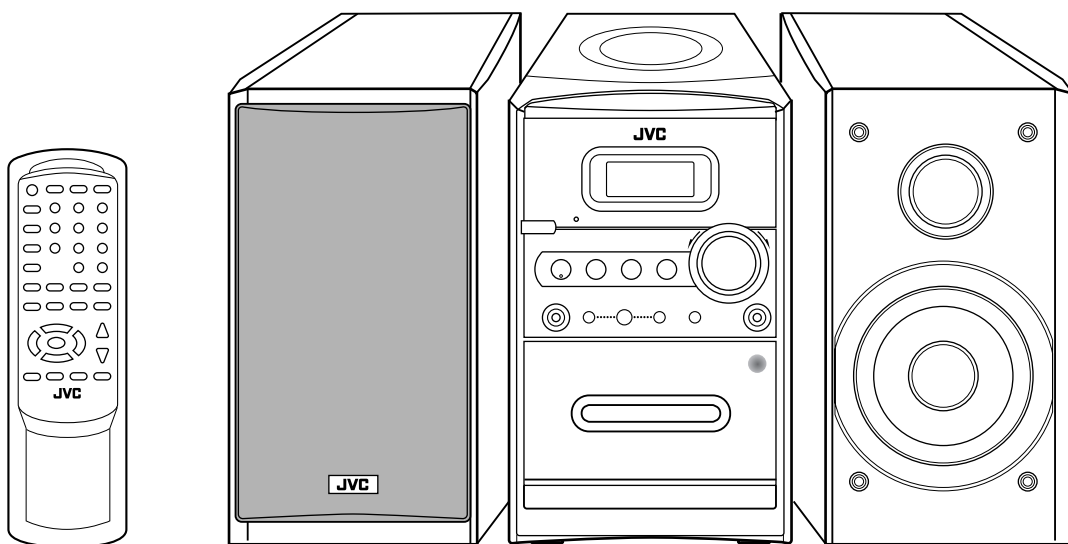

COMPACT  
**disc**  
DIGITAL AUDIO

**MP3**  
PLAYBACK

## INSTRUCTIONS

**For Customer Use:**

Enter below the Model No. and Serial No. which are located either on the rear, bottom or side of the cabinet. Retain this information for future reference.

Model No. \_\_\_\_\_

Serial No. \_\_\_\_\_

## Warnings, Cautions and Others

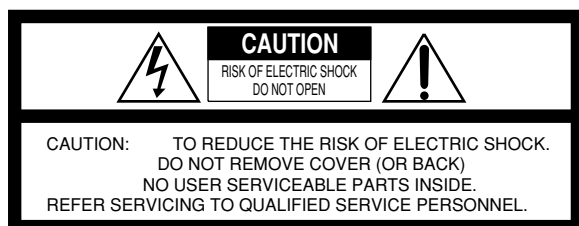

The lightning flash with arrowhead symbol, within an equilateral triangle is intended to alert the user to the presence of uninsulated "dangerous voltage" within the product's enclosure that may be of sufficient magnitude to constitute a risk of electric shock to persons.



The exclamation point within an equilateral triangle is intended to alert the user to the presence of important operating and maintenance (servicing) instructions in the literature accompanying the appliance.

### For U.S.A.

This equipment has been tested and found to comply with the limits for a Class B digital device, pursuant to part 15 of the FCC Rules. These limits are designed to provide reasonable protection against harmful interference in a residential installation.

This equipment generates, uses and can radiate radio frequency energy and, if not installed and used in accordance with the instructions, may cause harmful interference to radio communications. However, there is no guarantee that interference will not occur in a particular installation. If this equipment does cause harmful interference to radio or television reception, which can be determined by turning the equipment off and on, the user is encouraged to try to correct the interference by one or more of the following measures:

Reorient or relocate the receiving antenna.

Increase the separation between the equipment and receiver.

Connect the equipment into an outlet on a circuit different from that to which the receiver is connected.

Consult the dealer or an experienced radio/TV technician for help.

**WARNING: TO REDUCE THE RISK OF FIRE OR ELECTRIC SHOCK, DO NOT EXPOSE THIS APPLIANCE TO RAIN OR MOISTURE.**

### CAUTION— (STANDBY/ON) button!

Disconnect the mains plug to shut the power off completely (all lamps and indications go off). The  (STANDBY/ON) button in any position does not disconnect the mains line.

- When the unit is on standby, the STANDBY lamp lights red.
- When the unit is turned on, the STANDBY lamp goes off.

The power can be remote controlled.

### ATTENTION—Touche (STANDBY/ON)

Déconnectez la fiche secteur pour mettre l'appareil complètement hors tension (tous les témoins et toutes les indications s'éteignent). La touche  (STANDBY/ON) dans n'importe quelle position ne déconnecte pas l'appareil du secteur.

- Quand l'appareil est en mode d'attente, le témoin STANDBY est allumé en rouge.
- Quand l'appareil est sous tension, le témoin STANDBY s'éteint.

L'alimentation ne peut pas être commandée à distance.

### CAUTION

To reduce the risk of electrical shocks, fire, etc.:

1. Do not remove screws, covers or cabinet.
2. Do not expose this appliance to rain or moisture.

### ATTENTION

Afin d'éviter tout risque d'électrocution, d'incendie, etc.:

1. Ne pas enlever les vis ni les panneaux et ne pas ouvrir le coffret de l'appareil.
2. Ne pas exposer l'appareil à la pluie ni à l'humidité.

**For Canada/pour le Canada**

**CAUTION:** TO PREVENT ELECTRIC SHOCK, MATCH WIDE BLADE OF PLUG TO WIDE SLOT, FULLY INSERT.

**ATTENTION:** POUR EVITER LES CHOCS ELECTRIQUES, INTRODUIRE LA LAME LA PLUS LARGE DE LA FICHE DANS LA BORNE CORRESPONDANTE DE LA PRISE ET POUSSER JUSQU'AU FOND.

**For Canada/pour le Canada**

THIS DIGITAL APPARATUS DOES NOT EXCEED THE CLASS B LIMITS FOR RADIO NOISE EMISSIONS FROM DIGITAL APPARATUS AS SET OUT IN THE INTERFERENCE-CAUSING EQUIPMENT STANDARD ENTITLED "DIGITAL APPARATUS," ICES-003 OF THE DEPARTMENT OF COMMUNICATIONS.

CET APPAREIL NUMERIQUE RESPECTE LES LIMITES DE BRUITS RADIOELECTRIQUES APPLICABLES AUX APPAREILS NUMERIQUES DE CLASSE B PRESCRITES DANS LA NORME SUR LE MATERIEL BROUILLEUR: "APPAREILS NUMERIQUES", NMB-003 EDICTEE PAR LE MINISTRE DES COMMUNICATIONS.

1 CLASS 1 LASER PRODUCT

2 **CAUTION:** Do not open the top cover. There are no user serviceable parts inside the Unit; leave all servicing to qualified service personnel.

3 **CAUTION:** Visible and invisible laser radiation when open and interlock failed or defeated. Avoid direct exposure to beam.

4 REPRODUCTION OF LABEL: CAUTION LABEL, PLACED INSIDE UNIT.

1 PRODUIT LASER CLASSE 1

2 **ATTENTION:** N'ouvrez pas le couvercle supérieur. Il n'y a aucune pièce réparable par l'utilisateur à l'intérieur de l'appareil; confiez toute réparation à un personnel qualifié.

3 **ATTENTION:** Risque de radiations laser visible et invisible quand l'appareil est ouvert et que le système de verrouillage ne fonctionne pas ou a été mis hors service. Évitez toute exposition directe au rayon.

4 REPRODUCTION DE L'ÉTIQUETTE: ÉTIQUETTE DE PRÉCAUTION PLACÉE À L'INTERIEUR DE L'APPAREIL.

**CAUTION -** INVISIBLE LASER RADIATION WHEN OPEN AND INTERLOCKS DEFEATED. AVOID EXPOSURE TO BEAM.  
**VORSICHT !** UNSICHTBARE LASERSTRAHLUNG TRITTS AUS, WENN DECKEL, GEÖFFNET UND WENN SICHERHEITSVERRIEGELUNG ÜBERBRÜCKT IST. NICHT DEM STRAHL AUSSETZEN!  
**WARNING -** OSYNLIG LASERSTRÅLNING NÄR DENNA DEL ÄR ÖPPNAD OCH SPÄRR ÄR URKOPPLAD STRÅLEN ÄR FARLIG.  
**ADVARSEL -** USYNLIG LASERSTRÅLING VED ÅBNING NÄR SIKKERHEDSAFBRYDERE ER UDE AF FUNKTION. UNDGÅ UDSÆTTELSE FOR STRÅLING.

**CAUTION: Proper Ventilation**

To avoid risk of electric shock and fire, and to prevent damage, locate the apparatus as follows:

1 Front:

No obstructions and open spacing.

2 Sides/ Top/ Back:

No obstructions should be placed in the areas shown by the dimensions below.

3 Bottom:

Place on the level surface. Maintain an adequate air path for ventilation by placing on a stand with a height of 10 cm or more.

**Front view**

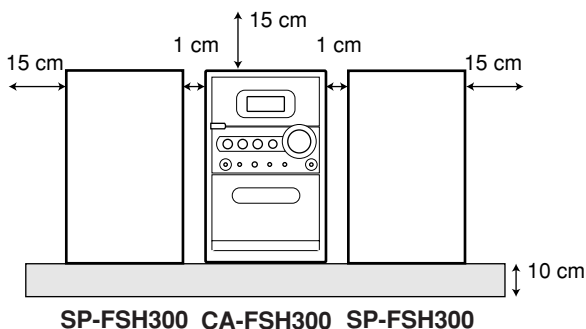

**Side view**

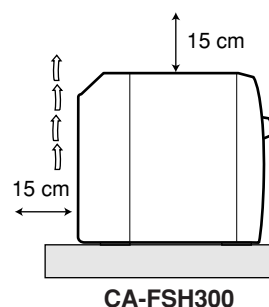

# Introduction

---

We would like to thank you for purchasing one of our JVC products. Before operating this unit, read this manual carefully and thoroughly to obtain the best possible performance from your unit, and retain this manual for future reference.

## About This Manual

---

This manual is organized as follows:

- **This manual mainly explains operations using the buttons on the remote control. You can use the buttons both on the remote control and on the unit for the same operations if they have the same or similar names (or marks), unless mentioned otherwise.**
- Basic and common information that is the same for many functions is grouped in one place, and is not repeated for each procedure. For instance, we do not repeat the information about turning on/off the unit, setting the volume, changing the sound effects, and others, which are explained in the section “Common Operations” on pages 8 and 9.
- The following symbols are used in this manual:



Gives you warning and caution to prevent damage or risk of fire/electric shock. In addition, we put information here about conditions which will prevent getting the best possible performance from the unit.



Gives you information and hints you need to know.

## Precautions

---

### Installation

- Install in a place which is level, dry and neither too hot nor too cold—between 5°C (41°F) and 35°C (95°F).
- Install the unit in a location with adequate ventilation to prevent internal heat buildup.
- Leave sufficient distance between the unit and the TV.
- Keep the speakers away from the TV to avoid interference with TV.



DO NOT install the unit in a location near heat sources, or in a place subject to direct sunlight, excessive dust or vibration.

### Power sources

- When unplugging the unit from the wall outlet, always pull on the plug, not the AC power cord.



DO NOT handle the AC power cord with wet hands.

### Moisture condensation

Moisture may condense on the lenses inside the unit in the following cases:

- After starting to heat the room.
- In a damp room.
- If the unit is brought directly from a cold to a warm place. Should this occur, the unit may malfunction. In this case, leave the unit turned on for a few hours until the moisture evaporates, unplug the AC power cord, then plug it in again.

### Others

- Should any metallic object or liquid fall into the unit, unplug the AC power cord and consult your dealer before operating any further.
- If you are not going to operate the unit for an extended period of time, unplug the AC power cord from the wall outlet.
- Rating label is placed on the exterior of the bottom.



DO NOT disassemble the unit since there are no user serviceable parts inside.

If anything goes wrong, unplug the AC power cord and consult your dealer.

# Contents

---

<b>Location of the Buttons and Controls .....</b>	<b>3</b>
Main Unit .....	3
Remote Control .....	5
<b>Getting Started .....</b>	<b>6</b>
Unpacking .....	6
Connecting AM and FM Antennas .....	6
Connecting Speakers .....	6
Connecting Other Equipment .....	7
Putting the Batteries into the Remote Control .....	7
<b>Common Operations .....</b>	<b>8</b>
Setting the Clock .....	8
Turning On the Power .....	8
Turning Off the Unit Automatically (Auto Standby) .....	8
Selecting the Source .....	9
Adjusting the Volume .....	9
Fade-Out Muting (FADE MUTING) .....	9
Selecting the Sound Modes .....	9
Reinforcing the Bass Sound .....	9
Checking the Clock Time During Play .....	9
<b>Playing Back Discs .....</b>	<b>10</b>
Playing Back the Entire Disc—Normal Play .....	10
Basic Disc Operations .....	11
Programming the Track Playing Order—Program Play .....	11
Repeating Tracks—Repeat Play .....	12
Playing at Random—Random Play .....	13
Displaying the Remaining Time during Playback .....	13
<b>Playing Back Tapes .....</b>	<b>14</b>
Playing Back a Tape .....	14
<b>Listening to FM and AM Broadcasts .....</b>	<b>15</b>
Tuning in to a Station .....	15
Presetting Stations .....	15
Tuning in to a Preset Station .....	16
<b>Using an External Equipment .....</b>	<b>16</b>
Listening to the External Equipment .....	16
<b>Recording .....</b>	<b>17</b>
Recording on a Tape .....	17
Recording Discs—Disc Synchronized Recording .....	18
<b>Using the Timers .....</b>	<b>19</b>
Using Daily Timer and Recording Timer .....	19
Using Snooze Timer .....	20
Using Sleep Timer .....	21
<b>Maintenance .....</b>	<b>22</b>
<b>Troubleshooting .....</b>	<b>23</b>
<b>Specifications .....</b>	<b>24</b>

# Location of the Buttons and Controls

Become familiar with the buttons and controls on your unit.

## Main Unit

Top view

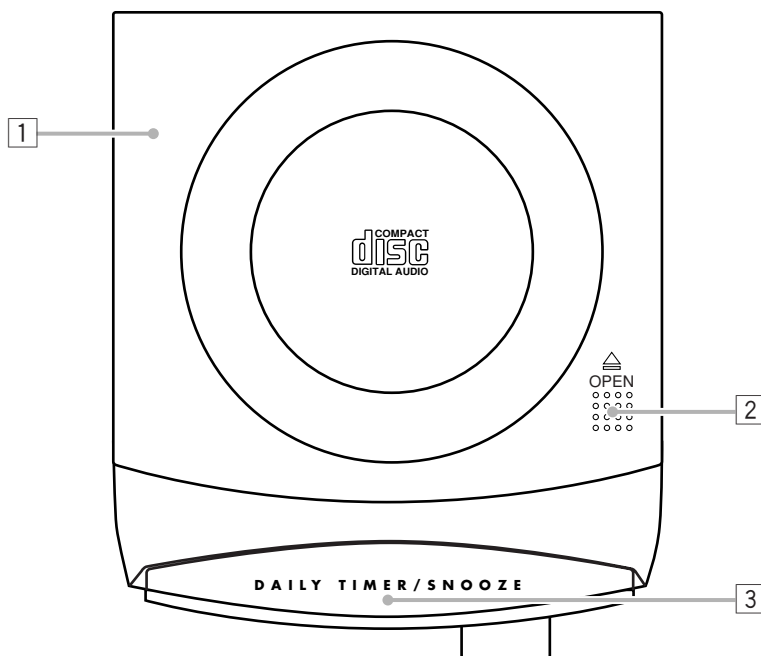



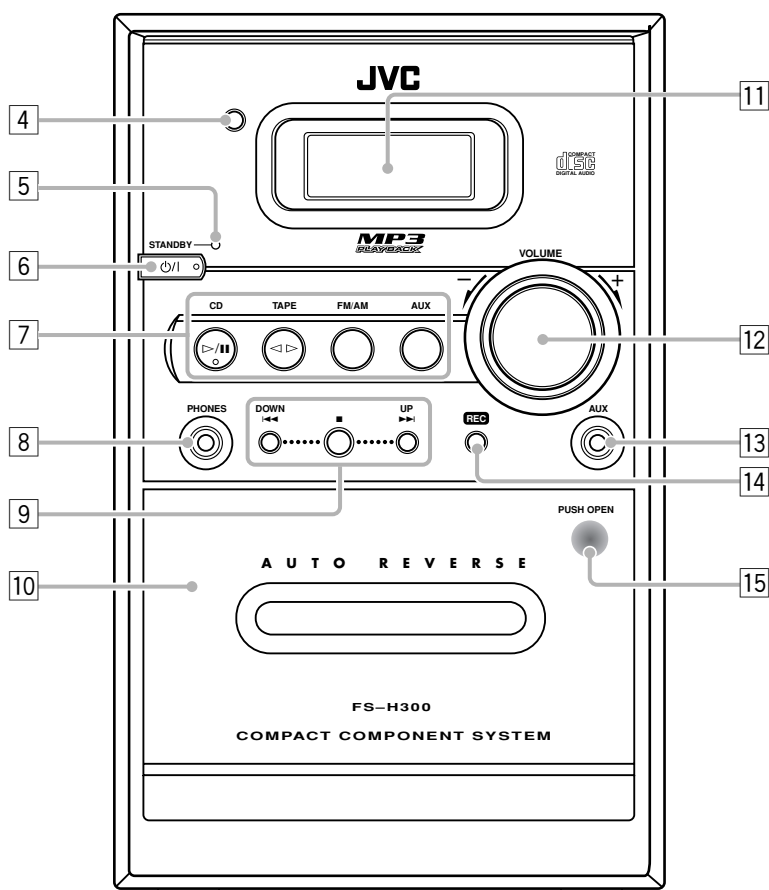

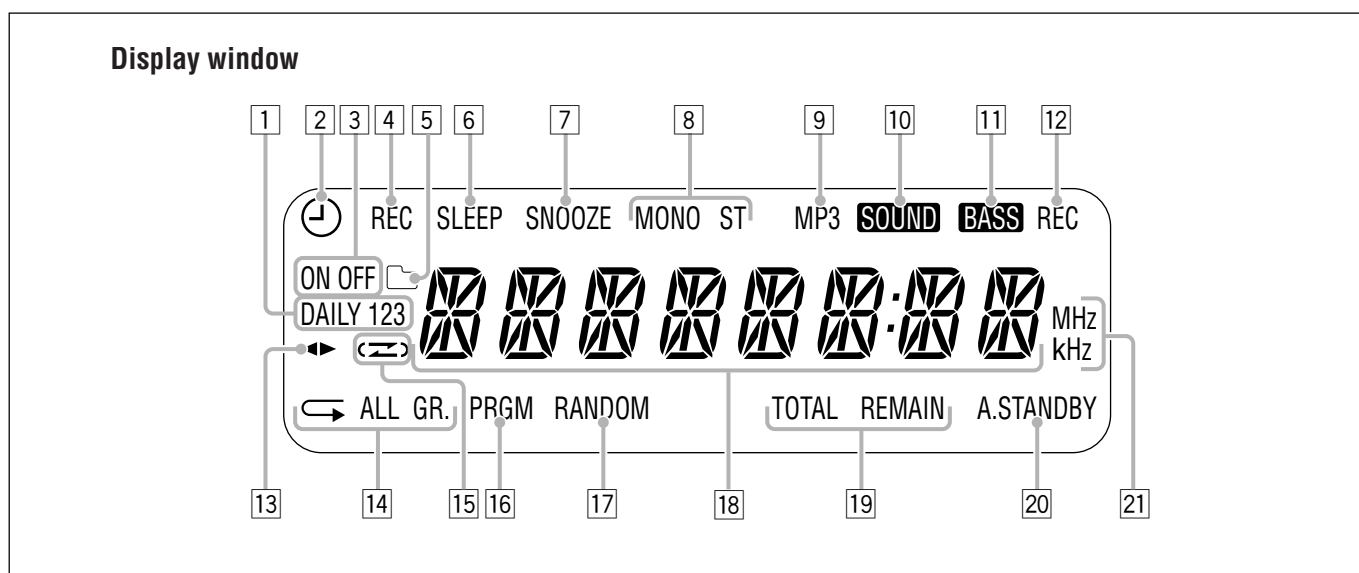

Front view









See pages in parentheses for details.

### Main unit

- 1 Disc cover (10)
- 2  OPEN (disc cover open) (10)
- 3 DAILY TIMER/SNOOZE button (20)
- 4 Remote sensor (5)
- 5 STANDBY lamp (8)
- 6  (STANDBY/ON) button (8)
- 7 Source buttons
  - CD , TAPE , FM/AM, AUX
  - Pressing one of these buttons also turns on the unit.*
- 8 PHONES jack (9)
- 9 Multi control buttons
  - DOWN , , UP 
- 10 Cassette holder (14, 17, 18)
- 11 Display window
- 12 VOLUME + / - control (9)
- 13 AUX jack (7, 17)
- 14 REC button (17, 18)
- 15 PUSH OPEN button (14, 17)

### Display window

- 1 DAILY 1/2/3 (timer number) indicator
- 2  (timer) indicator
- 3 ON/OFF (timer on-time/off-time) indicators
- 4 REC (recording timer) indicator
- 5  (group folder) indicator
- 6 SLEEP indicator
- 7 SNOOZE indicator
- 8 FM mode indicators
  - MONO, ST (stereo)
- 9 MP3 indicator
- 10 **SOUND** indicator
- 11 **BASS** indicator
- 12 REC (recording) indicator
- 13  (tape direction) indicator
- 14 Repeat indicators
  - , ALL, GR. (group)
- 15  (reverse mode) indicator
- 16 PRGM (program) indicator
- 17 RANDOM indicator
- 18 Main display
- 19 Remain indicators
  - TOTAL, REMAIN
- 20 A.STANDBY indicator
- 21 Frequency indicators
  - MHz, kHz

## Remote Control

See pages in parentheses for details.

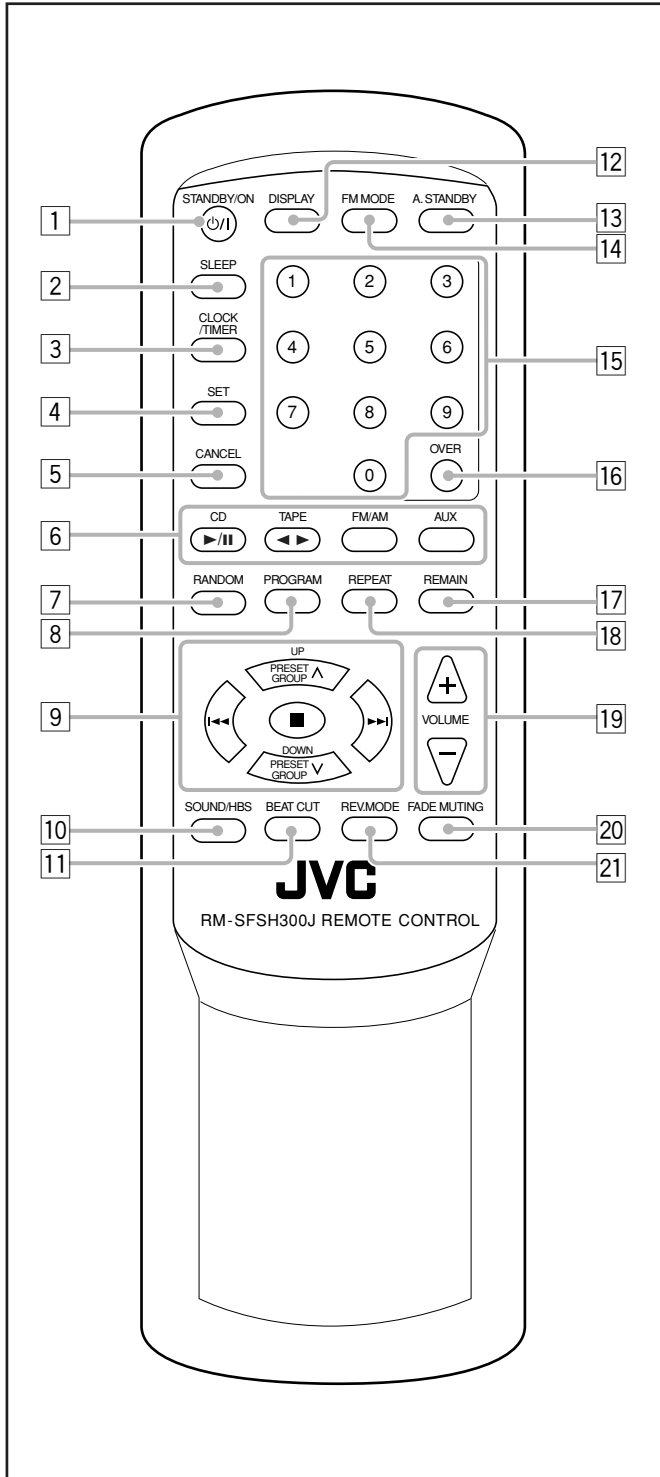

- 1 STANDBY/ON button (8, 20)
- 2 SLEEP button (21)
- 3 CLOCK/TIMER button (8, 19)
- 4 SET button (8, 15, 19, 20)
- 5 CANCEL button (19, 20)
- 6 Source buttons
  - CD , TAPE , FM/AM, AUX
  - Pressing one of these buttons also turns on the unit.*
- 7 RANDOM button (13)
- 8 PROGRAM button (11, 12)
- 9 Multi control buttons
  - PRESET GROUP , PRESET GROUP
  - , ,
- 10 SOUND/HBS button (9)
- 11 BEAT CUT button (17)
- 12 DISPLAY button (9)
- 13 A. (auto) STANDBY button (8)
- 14 FM MODE button (15)
- 15 Number buttons (11, 15, 16)
- 16 OVER button (11, 15, 16)
- 17 REPEAT button (13)
- 18 REPEAT button (12)
- 19 VOLUME + / - buttons (9, 20)
- 20 FADE MUTING button (9)
- 21 REV. (reverse) MODE button (14, 17, 18)

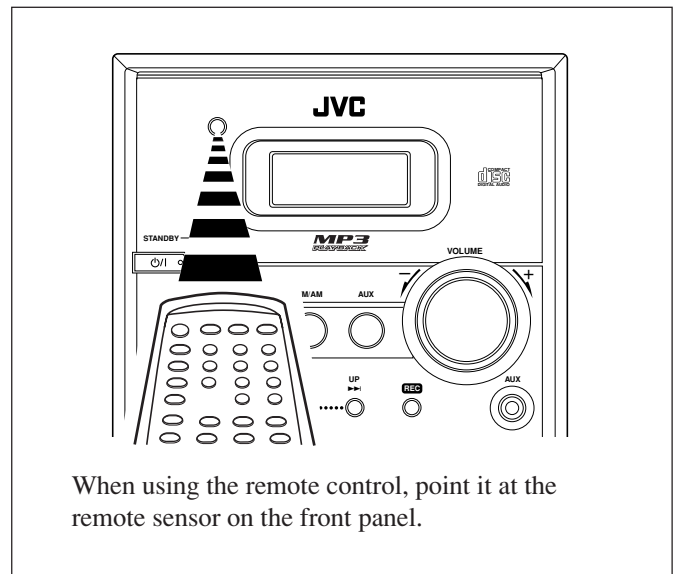

When using the remote control, point it at the remote sensor on the front panel.



## Unpacking

After unpacking, check to be sure that you have all the following items.

The number in parentheses indicates the quantity of each piece supplied.

- AM loop antenna (1)
- Remote control (1)
- Batteries (2)

If any item is missing, consult your dealer immediately.

## Connecting AM and FM Antennas

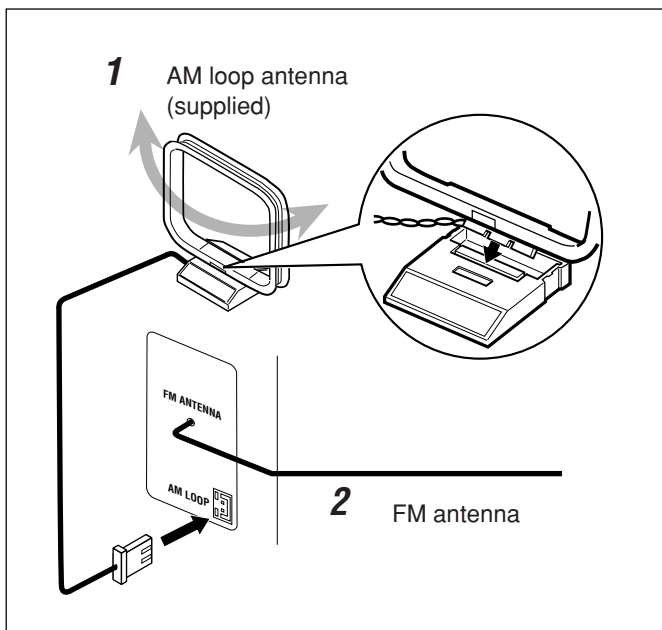

### 1 Connect the supplied AM loop antenna to the AM LOOP terminal.

Place the antenna away from the unit and adjust its position for the best reception.

### 2 Adjust the position for the FM antenna for the best reception.



#### For better reception of both FM and AM

- Make sure the antenna conductors do not touch any other terminals or connecting cords.
- Keep the antennas away from metallic parts of the unit, connecting cords, and the AC power cord.

## Connecting Speakers

You can connect the speakers using the speaker cords.

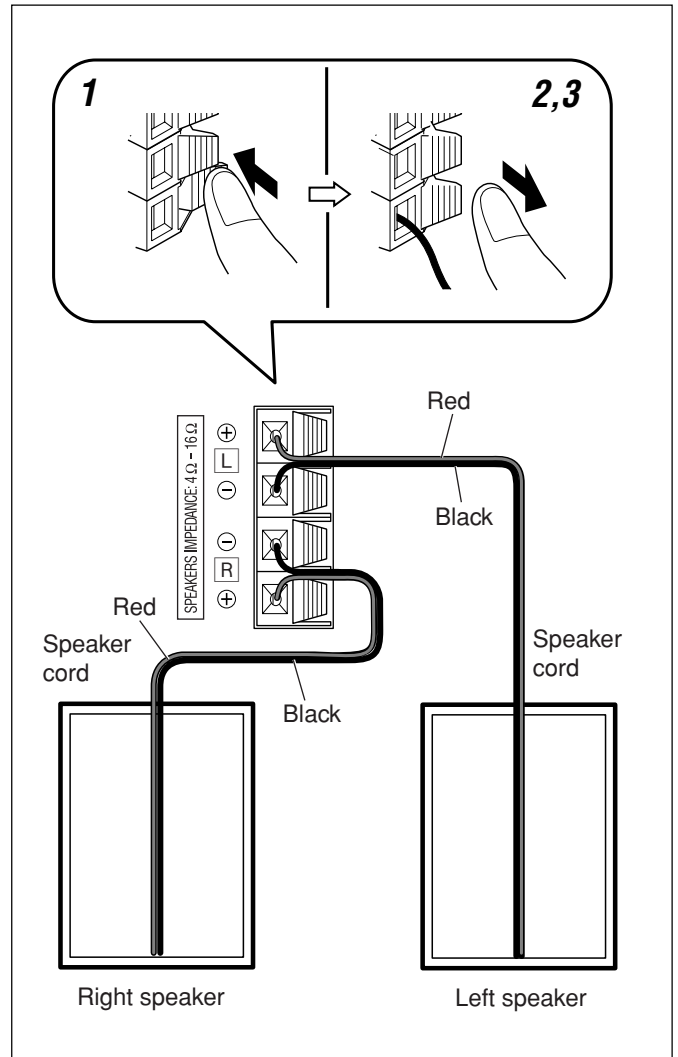

### 1 Hold the clamp of the speaker terminal.

### 2 Insert the end of the speaker cord into the terminal.

Match the polarity of the speaker terminals: red cord to ⊕ and black cord to ⊖.

### 3 Release your finger from the clamp.

#### IMPORTANT:

- Use only speakers with the same speaker impedance as indicated by the speaker terminals on the rear of the unit.
- DO NOT connect more than one speaker to one speaker terminal.

Do not connect the AC power cord until all other connections have been made.

## To remove the speaker grilles

The speaker grilles are removable as the illustration below.

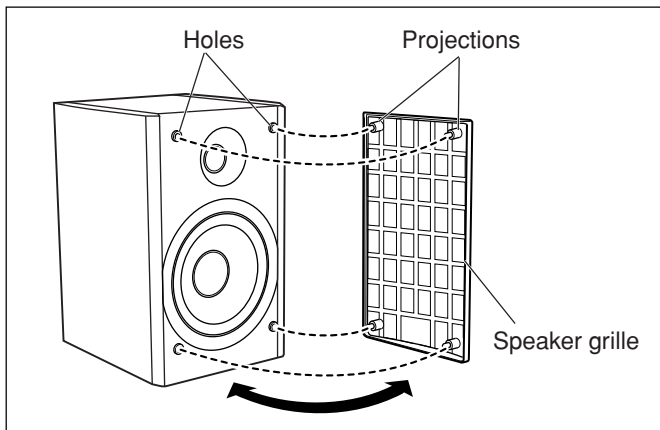

**To remove the speaker grille**, insert your fingers around the projection at the top of the speaker grille, then pull gently towards you while holding the side.

Do the same for the rest of projections one at a time.

**To attach the speaker grille**, put the projections of the speaker grille into the holes of the speaker.

## Connecting Other Equipment

### To connect an audio equipment

You can connect audio equipment—used only as a playback device.



- DO NOT connect any equipment while the power is on.
- DO NOT plug in any equipment until all connections are complete.

**For playing other equipment through this unit**, connect between the audio output jacks on the other equipment and AUX jack by using audio cords with mini plugs (not supplied).

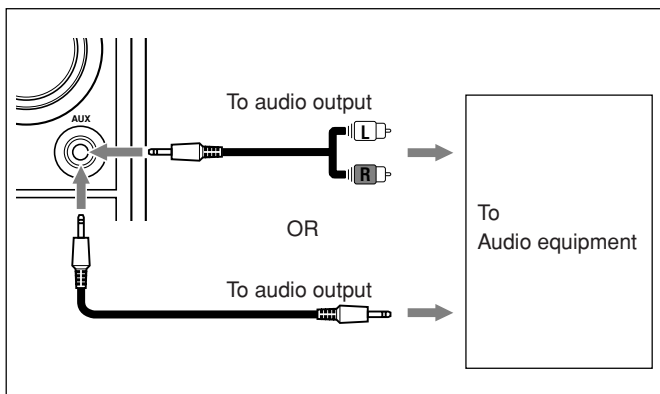

When the audio equipment has pin jacks for audio output: Be sure that the pin plugs of the audio cords are colored—white plugs and jacks are for left audio signals, and red ones for right audio signals.

## Putting the Batteries into the Remote Control

Insert the batteries—AAA/UM-4/R03—into the remote control by matching the polarity (+ and –) on the batteries with the + and – marking on the battery compartment.

When the remote control can no longer operate the unit, replace both batteries at the same time.

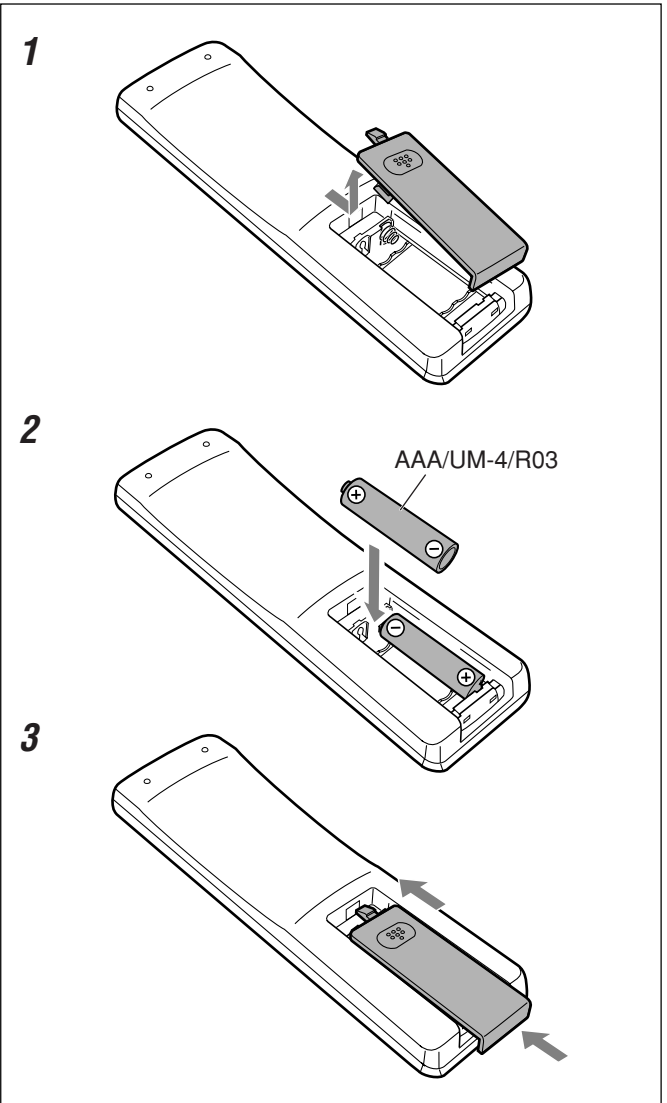

- DO NOT use an old battery together with a new one.
- DO NOT use different types of batteries together.
- DO NOT expose batteries to heat or flame.
- DO NOT leave the batteries in the battery compartment when you are not going to use the remote control for an extended period of time. Otherwise, the remote control will be damaged from battery leakage.

**NOW you are ready to plug in the unit.**

### IMPORTANT:

Be sure to check that all connections have been made before plugging in the power cord.

## Setting the Clock

Before operating the unit any further, first set the unit's clock. When you plug in the power cord, "AM 12:00" starts flashing on the display. You can set the clock when the unit is either turned on or in standby mode.

### On the remote control ONLY:

#### 1 Press CLOCK/TIMER.

The hour indication and AM (or PM) start flashing.

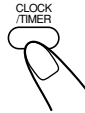

#### 2 Press UP or DOWN to adjust the hour, then press SET.

- When you press and hold UP or DOWN, the hour indication changes continuously.

The minute indication starts flashing.

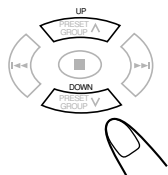

- The clock is working even while setting.

#### 3 Press UP or DOWN to adjust the minute, then press SET.

- When you press and hold UP or DOWN, the minute indication changes continuously.

The built-in clock starts.

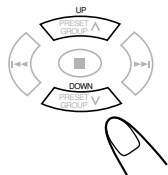
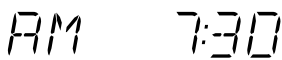

- **When you unplug the AC power cord or if a power failure occurs**  
The clock is reset to "AM 12:00." If this happens, set the clock again.
- **The clock may gain or lose 1 to 2 minutes per month**  
If this happens, reset the clock.

## To adjust the clock

### On the remote control ONLY:

#### 1 Press CLOCK/TIMER repeatedly to show the current time indication.



The hour indication and AM (or PM) start flashing.



#### 2 Repeat steps 2 and 3 on the left column.

## Turning On the Power

To turn on the unit, press STANDBY/ON . The STANDBY lamp on the unit goes off.

- When you press the source button—CD , TAPE , FM/AM and , the unit automatically turns on.

To turn off the unit (standby), press STANDBY/ON  again.

The STANDBY lamp on the unit lights red.

- "AM 12:00" flashes on the display until you set the built-in clock. After setting the clock, the clock time will appear on the display while the unit is in standby mode.
- A little power is always consumed even while the unit is in standby mode.



To switch off the power supply completely, unplug the AC power cord from the AC outlet.

## Turning Off the Unit Automatically (Auto Standby)

Using Auto Standby, the unit automatically turns itself off (on standby) about 3 minutes after playing back a disc or a tape.

- You can also turn off the unit automatically by using the Sleep Timer. (See page 21.)

### On the remote control ONLY:

To activate Auto Standby, press A.STANDBY. The A.STANDBY indicator appears on the display.

- When the playback is stopped, the A.STANDBY indicator starts flashing on the display.

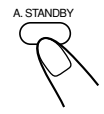

To deactivate Auto Standby, press A.STANDBY again. The A.STANDBY indicator goes off.

## Selecting the Source

To select the source, press CD ►/II, TAPE ◀►, FM/AM, or AUX.

- When you select CD as the source, playback starts automatically.

To operate the CD player, see pages 10 to 13.

To operate the tape deck, see page 14.

To operate the tuner (FM or AM), see pages 15 and 16.

To record on a tape, see pages 17 and 18.

To use an external equipment, see page 16.

## Adjusting the Volume

You can adjust the volume level only while the unit is turned on. The volume level can be adjusted between “VOL MIN,” “VOL 1” – “VOL 29,” and “VOL MAX.”

- The volume level has no effect on recording.

To increase the volume, press VOLUME + (or turn VOLUME control clockwise on the unit).

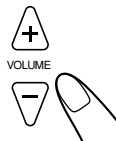

To decrease the volume, press VOLUME – (or turn VOLUME control counterclockwise on the unit).

- When you press and hold either button, you can change the volume level continuously.

VOL 10



### For private listening

Connect a pair of headphones to the PHONES jack. No sound comes out of the speakers. Be sure to turn down the volume before connecting or putting on the headphones.



DO NOT turn off (standby) the unit with the volume set to an extremely high level; otherwise, the sudden blast of sound can damage your hearing, speakers and/or headphones when you turn on the unit or start playing any source. REMEMBER you cannot adjust the volume level while the unit is in standby mode.

## Fade-Out Muting (FADE MUTING)

### On the remote control ONLY:

Press FADE MUTING.

The volume level decreases to “VOL MIN,” and “MUTING” appears on the display.



To release muting, press FADE MUTING again. The volume level resumes to the previous level.

## Selecting the Sound Modes

You can select one of the 4 sound modes.

- This function also affects the sound from headphones.
- This function only affects the playback sound, and does not affect your recording.

### On the remote control ONLY:

To select the sound modes, press SOUND/HBS repeatedly.

- Each time you press the button, the sound mode changes as follows:

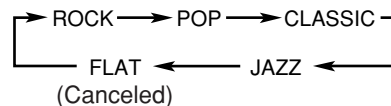

**ROCK:** Powerful sound emphasizing treble and bass.

**POP:** More presence in the vocals and midrange.

**CLASSIC:** Enriched sound with fine treble and ample bass.

**JAZZ:** Accented lower frequencies for jazz-type music.

**FLAT:** Equalizer effect is canceled.

**SOUND**  
ROCK

When the sound mode is activated, the **SOUND** indicator lights up on the display.

## Reinforcing the Bass Sound

You can boost the bass sound.

- This function only affects the playback sound, and does not affect your recording.

### On the remote control ONLY:

Press and hold SOUND/HBS.

- Each time you press and hold the SOUND/HBS, HBS turns on and off.



**BASS**  
HBS ON

When the HBS is activated, the **BASS** indicator lights up on the display.

## Checking the Clock Time During Play

### On the remote control ONLY:

Press DISPLAY.

- Each time you press the button, the display changes the clock indication and the normal indication alternately. After changing the display to the clock indication, operating any button or control also changes the display to the normal indication.

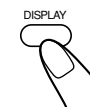

# Playing Back Discs

This unit has been designed to play back the following discs—CD, CD-R, and CD-RW.

You can play back the discs containing the tracks in music CD format or MP3 files in ISO 9660 format.

- In this instruction, we call a disc recorded MP3 files “MP3 disc,” and “file” is also referred to as “track.”

## When playing CD-Rs or CD-RWs

- Before playing CD-Rs or CD-RWs, read their instructions or cautions carefully.
- User-edited CD-Rs (CD-Recordable) and CD-RWs (CD-ReWritable) can be played only if they are already “finalized.”
- This unit supports “multi-session” discs (up to 5 sessions).
- This unit cannot play “packet write” discs.
- Some CD-Rs or CD-RWs may not play on this unit because of their disc characteristics, damage or stain on them, or if the player’s lens is dirty.
- CD-RWs may require a longer readout time. This is because the reflectance of CD-RWs is lower than for regular discs.

## Notes for MP3 files

- The player can only recognize files with “MP3” or “mp3” as the extensions, which can be in any combination of upper and lower case. The file name needs to be up to 20 characters.
- This unit recognizes files and folders on a disc in the following conditions:
  - up to 640 MP3 files.
  - up to 256 folders (including the root folder).
  - up to 8th layers (including the root folder).
- It is recommended that you record your material at a 44.1 kHz sampling rate, using the 128 kbps data transfer rate.
- Some MP3 files or discs may not be played back because of their characteristics or recording conditions.
- MP3 discs requires a longer readout time than normal discs because of the complexity of the folder/file configuration.
- MP3i and MP3 Pro are not available.

## General notes

In general, you will have the best performance by keeping your discs and the mechanism clean.

- Store discs in their cases, and keep them in cabinets or on shelves.
- Keep the unit’s disc cover closed when not in use.
- Continued use of irregular shape discs (heart-shape, octagonal, etc.) can damage the unit.



## Playing Back the Entire Disc—Normal Play

### 1 Press OPEN on top of the unit.

The disc cover opens.

- You can insert a disc while listening to another source.

### 2 Place a disc correctly with its label side up.

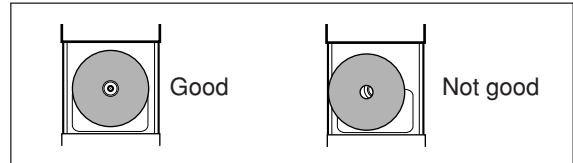

### 3 Close the disc cover gently.

### 4 Press CD .

The unit automatically turns on and the source changes to the CD player.

After loading the disc, the first track of the disc starts playing.

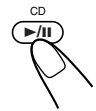

**When playing audio CD:**

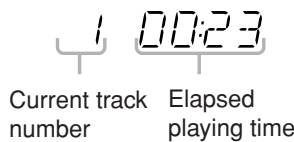

**When playing MP3 disc:**

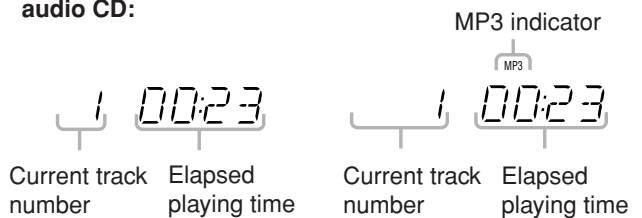

- The disc automatically stops when the last track has finished playing.



### While “READING” appears on the display

You cannot make any operation until the unit finishes reading the disc.



### While playing back an MP3 disc

ID3 Tag information (the name of the title, artist, and album up to 30 characters) will be shown on the display. When the name is too long to be displayed at once, it is scrolled.

### To stop playing, press .

The total track (or group) number and total playing time appear on the display.

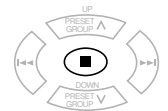

**When stop playing audio CD:**



**When stop playing MP3 disc:**

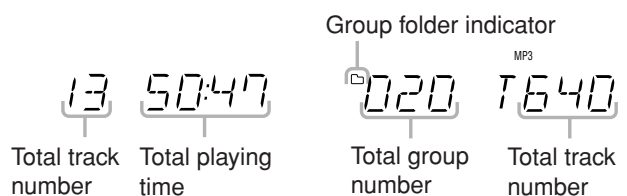

- Total playing time does not appear when MP3 disc is loaded.

To remove the disc, press  $\triangle$  OPEN on the unit, then take out the disc by holding it at the edges while pressing the unit's pivot lightly.



- If the disc cannot be read correctly (because it is scratched, for example) or an unreadable CD-R or CD-RW is inserted Playback will not start.
- If no disc is inserted "NO DISC" appears on the display.



DO NOT open the disc cover by hand as it will be damaged.

## Basic Disc Operations

While playing a disc, you can do the following operations.

### To stop playing for a moment

During play, press CD  $\blacktriangleright/\parallel$ .

While pausing, current track number and elapsed playing time flash on the display.



To resume playing, press CD  $\blacktriangleright/\parallel$  again.

### To go to another track

Before or during play, press  $\blacktriangleright\blacktriangleright$  or  $\blacktriangleleft\blacktriangleleft$  (or UP  $\blacktriangleright\blacktriangleright$  or DOWN  $\blacktriangleleft\blacktriangleleft$  on the unit) repeatedly.

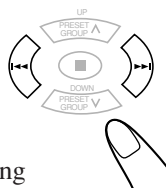

- $\blacktriangleright\blacktriangleright$  (UP  $\blacktriangleright\blacktriangleright$ ): Skips to the beginning of the next or succeeding tracks.
- $\blacktriangleleft\blacktriangleleft$  (DOWN  $\blacktriangleleft\blacktriangleleft$ ): Goes back to the beginning of the current or previous tracks.

### To go to another track directly using the number buttons

#### On the remote control ONLY:

Pressing the number button(s) before or during play allows you to start playing the track number you want.

Ex.: For track number 5, press 5.

For track number 15, press OVER, then press 1, 5.

For track number 20, press OVER, then press 2, 0.

(For MP3 disc only)

For track number 20, press OVER, then press 0, 2, 0.

For track number 156, press OVER, then press 1, 5, 6.

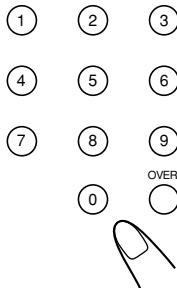

### To locate a particular point in a track

During play, press and hold  $\blacktriangleright\blacktriangleright\blacktriangleright$  or  $\blacktriangleleft\blacktriangleleft\blacktriangleleft$  (or UP  $\blacktriangleright\blacktriangleright\blacktriangleright$  or DOWN  $\blacktriangleleft\blacktriangleleft\blacktriangleleft$  on the unit).

- $\blacktriangleright\blacktriangleright\blacktriangleright$  (UP  $\blacktriangleright\blacktriangleright\blacktriangleright$ ): Fast-forwards the tracks.
- $\blacktriangleleft\blacktriangleleft\blacktriangleleft$  (DOWN  $\blacktriangleleft\blacktriangleleft\blacktriangleleft$ ): Fast-reverses the tracks.

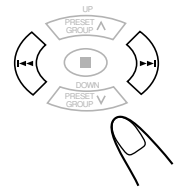

While playing back an MP3 disc This function is not available.

## Programming the Track Playing Order —Program Play

You can arrange the order in which tracks play before you start playing. You can program up to 40 tracks.

### On the remote control ONLY:

#### 1 Place a disc.

- If the current source is not the CD player, press CD  $\blacktriangleright/\parallel$ , then  $\blacksquare$  before going to the next step.

#### 2 Press PROGRAM.

The PRGM (program) indicator appears on the display.



0 P:01  
PRGM

#### 3 Press $\blacktriangleright\blacktriangleright$ or $\blacktriangleleft\blacktriangleleft$ to select the track number, then press PROGRAM.

Track number      Program step number  
5      P:01  
PRGM

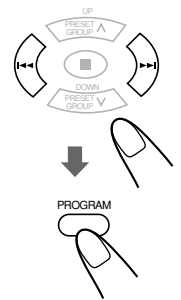

You can also use the number button(s) to select a track number.

- For the operation of the number buttons, see "To go to another track directly using the number buttons" on the left column.

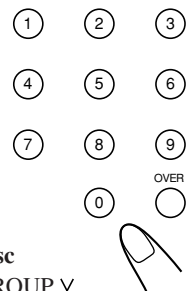

#### When you are programming from MP3 disc

Pressing PRESET GROUP  $\wedge$  or PRESET GROUP  $\vee$  selects the first track of each group.

**4 Repeat step 3 to program other tracks you want.**

**5 Press CD ►/II.**

The tracks are played in the order you have programmed.

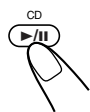

**If you try to program a 41st track**  
“-- FULL --” will appear on the display.

To stop playing, press ■.

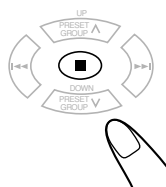

**To check the program contents**

You can check the program contents by pressing PROGRAM repeatedly before or after playback.



**To modify the program**

Press PROGRAM repeatedly until the program step number you want to modify appears. Then follow step 3 of the programming procedure.



- Pressing 0 deletes the selected step.

To add tracks in the program, press PROGRAM repeatedly until “0” appears as the track number. Then follow steps 3 of the programming procedure.



**To clear the program**

Press ■ before or after playback. The PRGM indicator disappears from the display and all the memory contents will be erased (resumes to Normal Play).

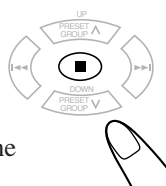

- The programmed tracks are also erased in the following cases:
  - Pressing  OPEN to open the disc cover.
  - Turning off the unit.
  - Changing the source.



**During Program Play**

Auto Standby function does not take effect.

**Repeating Tracks—Repeat Play**

You can have all the tracks, the program or individual track currently playing, repeat as many times as you like.

**On the remote control ONLY:**

Press REPEAT repeatedly before or during playback.

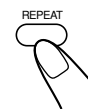

- Each time you press the button, Repeat Play changes as follows, and the following repeat indicators light up on the display:



5 00:23



Repeat indicators

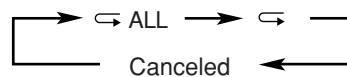

**When playing back audio CD:**

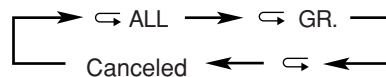

-  ALL: In Normal Play, repeats all the tracks. In Program Play, repeats all the tracks in the program.
-  : Repeats one track.

**When playing back MP3 disc:**



-  ALL: In Normal Play, repeats all the tracks. In Program Play and Random Play, repeats all the tracks in the program.
-  GR.: In Normal Play, repeats all the tracks in a group. In Program Play and Random Play, this function is not available.
-  : Repeats one track. In Random Play, this function is not available.

To cancel Repeat Play, press REPEAT repeatedly until the repeat indicator goes off.

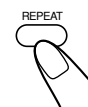

## Playing at Random—Random Play

You can play the tracks at random.

### On the remote control ONLY:

#### Press RANDOM.

The RANDOM indicator lights up on the display.



To exit from Random Play, press ■ or RANDOM.

The RANDOM indicator goes off.

- It is not possible to activate the Random Play function during Program Play.

## Displaying the Remaining Time during Playback

You can display the remaining time of the current track/disc and the elapsed time of the current track/disc during playing.

### On the remote control ONLY:

#### Press REMAIN repeatedly.

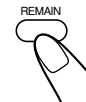

#### When playing back audio CD:

- Each time you press the button, the display changes as follows, and the following remain indicators light up on the display:



Remain indicators

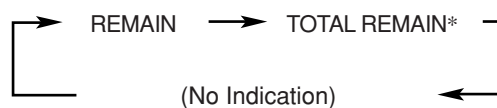

**REMAIN:** Shows the remaining time of the current track.

**TOTAL REMAIN:** Shows the remaining time of the disc.

**No indication:** Shows the elapsed time of the current track.

\* Remaining time of the disc (TOTAL REMAIN) will not be displayed in the following cases:

- During Random Play.
- During Program Play.

#### When playing back MP3 disc:

- Each time you press the button, the display changes as follows:

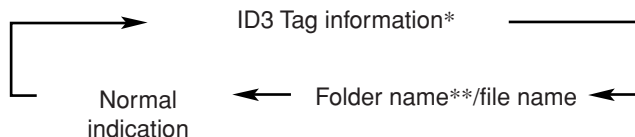

\* ID3 Tag information shows the name of the title, artist, and album in sequence. If the file does not have any information, “NO INFO” appears.

\*\* When a file does not belong in any folder, “ROOT” appears.



# Playing Back Tapes

## Playing Back a Tape

You can play back type I tapes only.

### 1 Press PUSH OPEN.

The cassette holder opens.

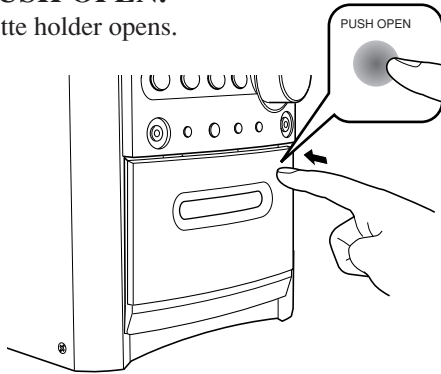

### 2 Put a cassette in with the exposed part of the tape down.

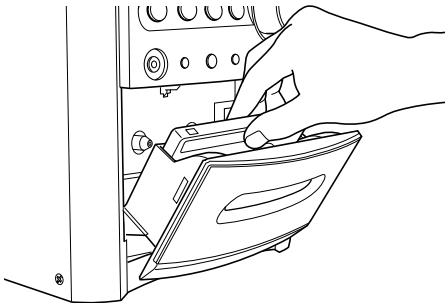

### 3 Close the cassette holder gently.

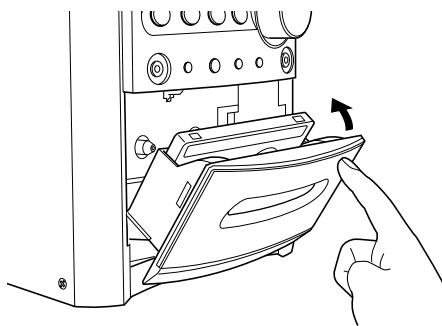

- When a tape is inside of the cassette holder, the tape direction indicator (▶) lights up on the display.

### 4 Press TAPE ◀▶.

Playback starts (if the unit has been on standby, the unit automatically turns on). The tape direction indicator (▶ or ◀) starts flashing slowly on the display.

- Each time you press the button, the tape direction changes:

- ▶: plays the front side.
- ◀: plays the reverse side.

When the tape plays to the end, the deck automatically stops if the Reverse Mode is set to or . (See “To play both sides—Reverse Mode.”)



If no cassette is inserted when you press TAPE ◀▶ “NO TAPE” appears on the display.

To stop playing, press ■.

To fast-wind to the left or to the right, press or (or UP or DOWN on the unit).

The tape direction indicator (▶ or ◀) starts flashing rapidly on the display.

To remove the cassette, press PUSH OPEN on the unit while playback is stopped.

### To play both sides—Reverse Mode

You can set the deck to play just one side of a tape, both sides once, or both sides continuously.

#### On the remote control ONLY:

#### Press REV.MODE (reverse mode).

- Each time you press the button, the Reverse Mode changes as follows:

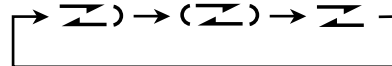

- : The deck automatically stops after playing both sides of the tape. Stops when playback in the 2 direction is finished.
- : The deck continues to play both sides of the tape 10 times, then stops playback automatically.
- : The deck automatically stops after playing one side of the tape.

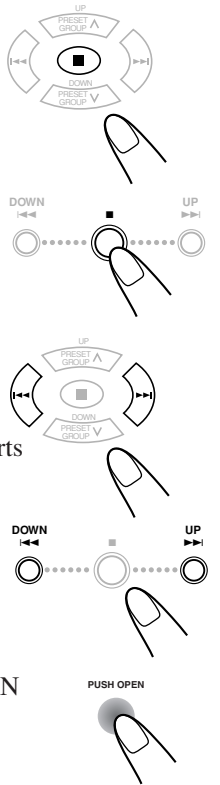

- DO NOT turn off the unit while playing back or recording a tape. The cassette deck or tapes may be damaged.
- The use of C-120 or longer tape is not recommended, since characteristic deterioration may occur and this tape easily jams in the pinch rollers and the capstans.
- This unit is not compatible with type II and type IV tapes.

# Listening to FM and AM Broadcasts

## Tuning in to a Station

### 1 Press FM/AM to select either “FM” or “AM.”



The unit automatically turns on and tunes in to the previously received station—either FM or AM.

- Each time you press the button, the band alternates between FM and AM.

FM 87.50 MHz

- If the station previously selected is stored in a preset number, the preset number will appear instead of “FM” or “AM.”

### 2 Press and hold ►►► or ◄◄◄ (or UP ►►► or DOWN ◄◄◄ on the unit) for more than 1 second.

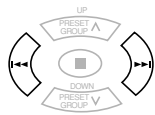

- ►►► (UP ►►►): Increases the frequencies.
- ◄◄◄ (DOWN ◄◄◄): Decreases the frequencies.

The unit starts searching for stations and stops when a station of sufficient signal strength is tuned in.

- If an FM program is broadcast in stereo, the ST (stereo) indicator lights up on the display (only when the reception is good).

To stop during searching, press ►►► or ◄◄◄ (or UP ►►► or DOWN ◄◄◄ on the unit).



When you repeatedly press ►►► or ◄◄◄ (or UP ►►► or DOWN ◄◄◄ on the unit)

The frequency changes step by step.

### To change the FM reception mode

#### On the remote control ONLY:

When an FM stereo broadcast is hard to receive or noisy, press FM MODE so that the “MONO” appears on the display. The MONO indicator also lights up. Reception will improve.



To restore the stereo effect, press FM MODE again so that “STEREO” appears on the display and the MONO indicator goes off. In stereo mode, you can hear stereo sound when a stereo program is broadcast.

The stereo effect also restores when:

- Changing the band (FM or AM).
- Changing the station frequency.
- Changing the playing source.
- Turning off (or on) the unit.

## Presetting Stations

You can preset 25 FM and 15 AM stations manually.

In some cases, test frequencies have been already stored for the tuner since the factory examined the tuner preset function before shipment. This is not a malfunction. You can preset the stations you want into memory by following the presetting method.

- There is a time limit in doing the following steps. If the setting is canceled before you finish, start again from step 2.

### On the remote control ONLY:

#### 1 Tune in to the station you want to preset.

- See “Tuning in to a Station” on the left column.

#### 2 Press SET.

“00” starts flashing on the display.

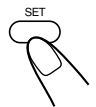

#### 3 Press PRESET GROUP ^ or PRESET GROUP v to select a preset number, then press SET.

The preset station is stored in memory.

- Even if you do not press SET, the station will automatically be stored on the selected preset number 5 seconds later.

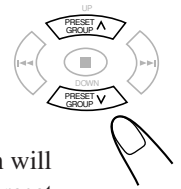

You can also use the number button(s) to select a preset number.

- In this case, you do not have to press SET.

Ex.: To select a preset number 5, press 5.

To select a preset number 15, press OVER, then press 1, 5.

To select a preset number 20, press OVER, then press 2, 0.

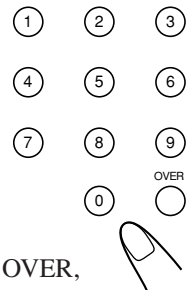

#### 4 To preset more stations, repeat steps 1 to 3 above, allocating a different preset number to each station.

- Storing a new station on an already assigned number erases the previously stored one.



When you unplug the AC power cord or if a power failure occurs

The preset stations will remain in the unit.

---

## Tuning in to a Preset Station

---

### On the remote control ONLY:

- 1** Press FM/AM to select either “FM” or “AM.”



The unit automatically turns on and tunes in to the previously received station—either FM or AM.

- Each time you press the button, the band alternates between FM and AM.

- 2** Press PRESET GROUP  $\wedge$  or PRESET GROUP  $\vee$  repeatedly to select a preset number.

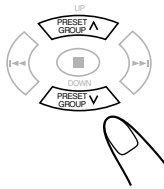

To tune in to a preset station directly using the number buttons

### On the remote control ONLY:

Pressing the number button(s) allows you to select the preset number you want.

Ex.: For preset number 5, press 5.

For preset number 15, press OVER, then press 1, 5.

For preset number 20, press OVER, then press 2, 0.

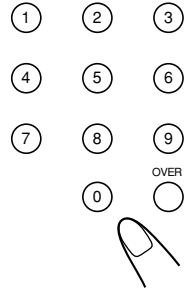

---

## Using an External Equipment

---

### Listening to the External Equipment

---

You can listen to the external equipment such as MD recorder, cassette deck, or other auxiliary.

- First, make sure that the external equipment is properly connected to the unit. (See page 7.)

- 1** Set the volume level to the minimum position.

- 2** Press AUX.

“AUX” appears on the display.



AUX

- 3** Start playing the external equipment.

- 4** Adjust the volume level to the level you want to listen to.

To exit AUX mode, select other source.



**For operation of the external equipment**

Refer to its instructions.

# Recording

## IMPORTANT:

- It should be noted that it may be unlawful to re-record pre-recorded tapes, records, or discs without the consent of the owner of copyright in the sound or video recording, broadcast or cable program and in any literary, dramatic, musical, or artistic embodied therein.
- The recording level is automatically set correctly, so it is not affected by the other sound settings. Thus, during recording you can adjust the sound you are actually listening to without affecting the recording level.
- If recordings you have made have excessive noise or static, the unit may be too close to a TV. Increase the distance between the TV and the unit.
- You can only use type I tape for recording.



- DO NOT turn off the unit while playing back or recording a tape. The cassette deck or tapes may be damaged.
- DO NOT use type II and type IV tapes since the unit is not compatible with such tapes.
- The use of C-120 or longer tape is not recommended, since characteristic deterioration may occur and this tape easily jams in the pinch rollers and the capstans.



### At the start and end of cassette tapes

There is leader tape which cannot be recorded onto. Thus, when recording from discs, FM/AM broadcasts, or external equipment, wind the leader tape first to ensure that the recording will be made without losing any music.

### To protect your recordings

Cassettes have two small tabs on the back to protect against unexpected erasure or re-recording. To protect your recording, remove these tabs. To re-record on a protected tape, cover the holes with adhesive tape.

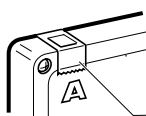

Adhesive tape

## Recording on a Tape

### On the unit ONLY:

- 1 Put a recordable cassette in with the exposed part of the tape down.**
  - See also page 14.
- 2 Close the cassette holder gently.**

- 3 Start playing the source—FM, AM, or auxiliary equipment connected to AUX jack.**
  - When the source is FM or AM, tune in to the station you want to record.
  - When recording from discs, see “Recording Discs—Disc Synchronized Recording” on page 18.

- 4 Press REC (recording).**
  - The REC indicator appears and ► indicator lights up on the display.



- 5 Press TAPE ◀▶.**
  - ► indicator starts flashing and the recording starts.



- If no cassette is inserted when you press REC “NO TAPE” appears on the display.
- If a protected tape is inserted when you press REC “PROTECT” appears on the display.



To stop recording for a moment, press REC. The recording is paused. To resume recording, press TAPE ◀▶.



To stop recording, press ■. The recording stops.

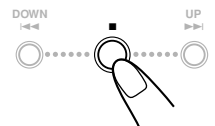

To remove the cassette, press PUSH OPEN while recording is stopped.

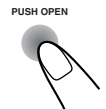

### To record on both sides—Reverse Mode

#### On the remote control ONLY:

Press REV.MODE (reverse mode) until ⤵ or ⤴ is lit.



- When using the Reverse Mode for recording, ⤴ lights up and start recording in the forward (►) direction first.

To cancel the Reverse Mode, press REV.MODE repeatedly until ⤵ is lit.

### To reduce the beat—Beat Cut

#### On the remote control ONLY:

If the beats are heard while recording an AM broadcast, press BEAT CUT repeatedly until the beats are reduced.



- Each time you press the button, the display alternates between “CUT-1” and “CUT-2.”

## Recording Discs —Disc Synchronized Recording

You can start disc play and recording at the same time.

### On the unit ONLY:

**1** Put a recordable cassette in with the exposed part of the tape down.

- See also page 14.

**2** Close the cassette holder gently.

**3** Press CD ▷/II to select the CD player as the source.

**4** Press ■ to stop the disc playback.

- You can make a program (see page 11) if you want.

**5** Press REC (recording).

- ▶ indicator lights up on the display.



**6** Press TAPE ◀▶.

“SYNC REC” appears and ▶ indicator starts flashing slowly on the display.

CD playback and tape recording starts automatically.



To stop recording for a moment, press REC.

Both the CD playback and tape recording are paused. To resume recording, press TAPE ◀▶.



To stop recording, press ■.

The recording stops and the CD playback is paused.

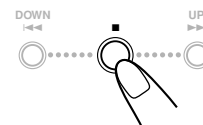

To record on both sides—Reverse Mode

On the remote control ONLY:

Press REV.MODE (reverse mode) repeatedly until ⤵ or ⤴ is lit.

- When using the Reverse Mode for Disc Synchronized Recording, ⤵ lights up and the recording starts in the forward (▶) direction first. When the tape reaches its end, the CD playback is paused until the tape recording changes to the reverse direction, then the recording continues.



To cancel the Reverse Mode, press REV.MODE repeatedly until ⤵ is lit.



**When making Sleep Timer settings while doing Disc Synchronized Recording**

Set enough time to allow for the disc to finish playing; otherwise, the power will go off before recording is completed.



- If no cassette is inserted when you press REC “NO TAPE” appears on the display.
- If a protected tape is inserted when you press REC “PROTECT” appears on the display.

# Using the Timers

There are four timers available—Daily Timer, Recording Timer, Snooze Timer, and Sleep Timer.

- Before using these timers, make sure the built-in clock is set correctly (see page 8).

## Using Daily Timer and Recording Timer

You can set the timer whether the unit is on or off.

### How the Timer actually works

When the on-time comes, the unit automatically turns on (the ☉ [timer] indicator flashes and continues flashing while the timer is operating). Then, when the off-time comes, the unit automatically turns off (standby). The timer setting remains in memory until you change it.

- When the ☉ (timer) and DAILY 1, 2, or 3 indicators are lit on the display, the timer acts as the Daily Timer. Once the timer has been set, it will be activated at the same time and automatically turns off (standby) after 60 minutes everyday until the timer is deactivated.
- When the ☉ (timer) and the REC indicators are lit on the display, the timer acts as the Recording Timer. After the timer-recording finishes, the details of the setting remain stored but the timer is turned off.

### Before you start...

When using “TUNER” as the source to play, make sure to select the desired station before turning off the power.

- There is a time limit in doing the following steps. If the setting is canceled before you finish, start again from step 1.

## On the remote control ONLY:

- 1 Press **CLOCK/TIMER** repeatedly to select the timer you want to adjust and activate—Daily 1, Daily 2, Daily 3, or Rec.



The timer setting and hour indication start flashing on the display.

Each time you press the button, the display changes as follows:

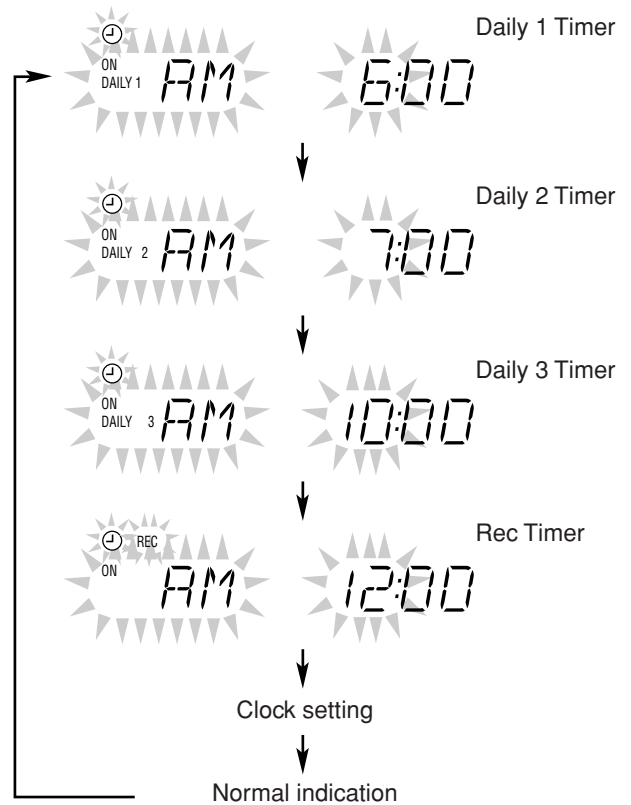

- 2 Set the on-time you want the unit to turn on.

- (1) Press UP or DOWN to set the hour, then press SET.
  - (2) Press UP or DOWN to set the minute, then press SET.
- If you want to change the time setting, press CANCEL.

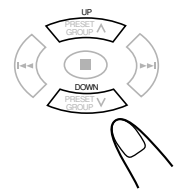

- If you are setting the Daily Timer, the source name starts flashing on the display. → Go to step 4.
- If you are setting the Recording Timer, the OFF indicator and hour indication start flashing on the display.

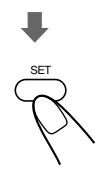

### 3 For the Recording Timer ONLY: Set the off-time you want the unit to turn off.



- (1) Press UP or DOWN to set the hour, then press SET.
  - (2) Press UP or DOWN to set the minute, then press SET.
- If you want to change the time setting, press CANCEL.
- The Recording Timer is activated. The  (timer) and REC indicators light up. The display returns to the normal indication.
- ➔ Go to step 7.

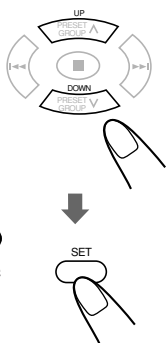

### 4 Press UP or DOWN to select the source to play.



Each time you press the button, the source changes as follows:



- Make sure the playing source (either a cassette tape or a disc) is inside when you select "TAPE" or "CD."

If you want to change the time setting, press CANCEL repeatedly to return step 2.

### 5 Press SET.

The  (timer) and active daily timer number indications lights up. The display returns to the normal indication.

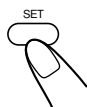

### 6 Press VOLUME +/- to adjust the volume for the on-time.

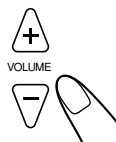

### 7 Press STANDBY/ON to turn off the unit if you have set the timer with the unit turned on.



#### On the unit ONLY:

To activate the timer, press and hold DAILY TIMER/SNOOZE on the unit repeatedly to select the timer number you want.



To deactivate the timer, press and hold DAILY TIMER/SNOOZE.



- Each time you press and hold the button, the timer setting changes as follows:

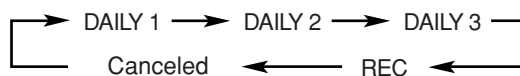

To change the timer, repeat steps 1 to 6 on pages 19 and this page.

- To activate the Daily Timer again without changing the setting, press DAILY TIMER/SNOOZE on the unit repeatedly to select the timer number you want.

**notes** When there is no playing source (either a cassette tape or a disc) inside when you select "TAPE" or "CD"

The source to play is changed to "TUNER" when the on-time comes.

**notes** If the unit is already turned on when the timer on-time comes

The timer does not work.

**notes** When you unplug the AC power cord or if a power failure occurs

The timer setting remains. Set the built-in clock and activate the timer again.

#### Using Snooze Timer

The Snooze Timer turns off the unit (standby) only for 5 minutes while Daily Timer is in operation.

- You can set the Snooze Timer only while the Daily Timer is in operation.

#### On the unit ONLY:

Press DAILY TIMER/SNOOZE while Daily Timer is in operation.



The unit turns off (standby) and the SNOOZE indicator appears on the display.

After 5 minutes, the unit automatically turns on with the source you selected in step 4 on the left column.

**notes** If the unit is turned on when the Snooze Timer is working

Both Snooze Timer and Daily Timer will be canceled.

**notes** If you set the Snooze Timer when there is less than 5 minutes until the Daily Timer off-time

The unit will not turn on even when 5 minutes passed.

**notes** When you unplug the AC power cord or if a power failure occurs

The timer will be canceled. You need to set the clock first, then the timer again.

## Using Sleep Timer

With Sleep Timer, you can fall asleep to your favorite music or radio program.

- You can set Sleep Timer only when the unit is turned on.
- You can also turn off the unit automatically by using Auto Standby. (See page 8.)

### How the Sleep Timer actually works

The unit automatically turns off after the specified length of time passes.

### On the remote control ONLY:

#### 1 Press SLEEP.

The SLEEP indicator starts flashing on the display.



90

- Each time you press the button, the length of time changes as follows:

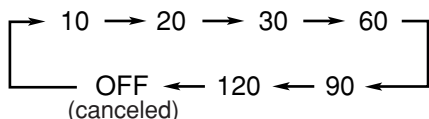

#### 2 Wait for about 5 seconds after specifying the length of time.

The SLEEP indicator remains lit on the display.

**To check the remaining time until shut-off time,** press SLEEP once. The remaining time until shut-off time appears for about 5 seconds.

**To change the shut-off time,** press SLEEP repeatedly until the length of time you want appears.

**To cancel the setting,** press SLEEP repeatedly until the SLEEP indicator goes off and display returns to the normal indication.

- Turning off the unit also cancels the Sleep Timer.



**When you set the Sleep Timer after the Daily Timer starts playing the selected source**

The unit turns off with either timer having an earlier shut-off time.



**If you set the Sleep Timer while playing back or recording a tape**

Do not shut the unit off with the Sleep Timer while a tape is running. If the unit turns off while playing back or recording a tape, the cassette deck or tapes may be damaged.



# Maintenance

To get the best performance of the unit, keep your discs, tapes and mechanism clean.

## General Notes

In general, you will have the best performance by keeping your discs, tapes and the mechanism clean.

- Store discs and tapes in their cases, and keep them in cabinets or on shelves.

## Cleaning the unit

### • Stains on the unit

Should be wiped off with a soft cloth. If the unit is heavily stained, wipe it with a cloth soaked in water-diluted neutral detergent and wrung well, then wipe clean with a dry cloth.

- **Since the unit may deteriorate in quality, become damaged or have its paint peel off, be careful about the following:**
  - DO NOT wipe it with a rough cloth.
  - DO NOT wipe it too vigorously.
  - DO NOT wipe it with thinner or benzine.
  - DO NOT apply any volatile substance such as an insecticide to it.
  - DO NOT allow any rubber or plastic to remain in contact with it for a long time.

## Handling discs



- Remove the disc from its case by holding it at the edge while pressing the center hole lightly.
- Do not touch the shiny surface of the disc, or bend the disc.
- Put the disc back in its case after use to prevent warping.

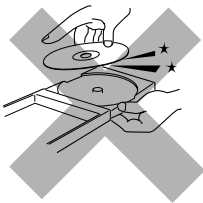

- Be careful not to scratch the surface of the disc when placing it back in its case.
- Avoid exposure to direct sunlight, temperature extremes, and moisture.

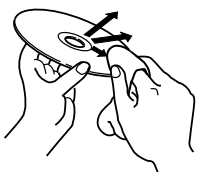

### To clean the disc

Wipe the disc with a soft cloth in a straight line from center to edge.



**DO NOT** use any solvent—such as conventional record cleaner, spray, thinner, or benzine—to clean the disc.

## Handling cassette tapes

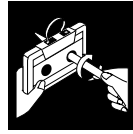

- If the tape is loose in its cassette, take up the slack by inserting a pencil in one of the reels and rotating.
- If the tape is loose, it may get stretched, cut, or caught in the cassette.



- Be careful not to touch the tape surface.



- Avoid storing tapes in any of the following places:
  - In dusty places
  - In direct sunlight or heat
  - In moist areas
  - On a TV or speaker
  - Near a magnet

## To keep the best recording and playback sound quality

You need to clean the heads.

- Clean the heads after every 10 hours of use with a wet-type head cleaning tape (available at electronic and audio shops).  
When the head becomes dirty, the following symptoms will occur:
  - Sound quality is reduced.
  - Sound level decreases.
  - Sound drops out.
- Do not play dirty or dusty tapes.
- Do not touch the highly-polished head with any metallic or magnetic tools.

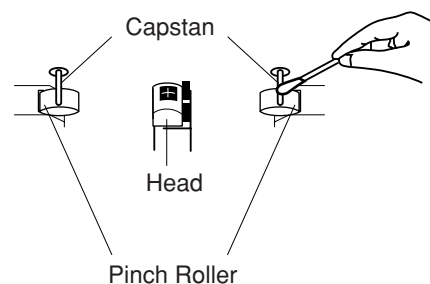

## To demagnetize the head

Turn off the unit, and use a head demagnetizer (available at electronic and audio shops).

# Troubleshooting

If you are having a problem with your unit, check this list for a possible solution before calling for service.

If you cannot solve the problem from the hints given here, or the unit has been physically damaged, call a qualified person, such as your dealer for service.

Symptom	Possible Cause	Action
Power does not come on.	The power cord is not connected to an AC outlet.	Insert the plug into the socket.
No sound is heard.	<ul style="list-style-type: none"> <li>• Connections are incorrect or loose.</li> <li>• A pair of headphones is connected.</li> <li>• MP3 disc is recorded with "packet writing."</li> </ul>	<ul style="list-style-type: none"> <li>• Check all connections and make corrections. (See pages 6 and 7.)</li> <li>• Unplug the headphones from the PHONES jack.</li> <li>• It cannot be played. Replace the disc.</li> </ul>
Hard to listen to broadcasts because of noise.	<ul style="list-style-type: none"> <li>• Antennas are disconnected.</li> <li>• The AM loop antenna is too close to the unit.</li> <li>• The FM antenna is not properly extended and positioned.</li> </ul>	<ul style="list-style-type: none"> <li>• Reconnect the antenna correctly and securely.</li> <li>• Change the position and direction of the AM loop antenna.</li> <li>• Extend FM antenna and orient to the best reception position.</li> </ul>
The disc does not play.	The disc is upside down.	Put the disc in with the label side up.
Impossible to record.	Small tabs on the back of the cassette are removed.	Cover the holes with adhesive tape.
Operations are disabled.	The built-in microprocessor has malfunctioned due to external electrical interference.	Unplug the AC power cord then plug it back in.
Unable to operate the unit by the remote control.	<ul style="list-style-type: none"> <li>• The path between the remote control and the remote sensor on the unit is blocked.</li> <li>• The batteries are exhausted.</li> <li>• You are using the remote control too far from the unit.</li> </ul>	<ul style="list-style-type: none"> <li>• Remove the obstruction.</li> <li>• Replace the batteries. (See page 7.)</li> <li>• Signals cannot reach the remote sensor. Move closer to the unit.</li> </ul>

## **Amplifier Section—CA-FSH300**

### **Output Power:**

**20 W per channel, min. RMS, driven into 4  $\Omega$  at 1 kHz with no more than 10% total harmonic distortion.**

Audio input sensitivity/Impedance (at 1 kHz)

AUX: 500 mV/50 k $\Omega$

Speakers Impedance: 4  $\Omega$  – 16  $\Omega$

### **Tuner**

FM tuning range: 87.5 MHz—108.0 MHz

AM tuning range: 530 kHz—1 710 kHz

### **CD player**

Dynamic range: 85 dB

Signal-to-noise ratio: 85 dB

Wow and flutter: Immeasurable

### **Cassette deck**

Frequency response:

Normal (type I): 100 Hz—10 000 Hz

Wow and flutter: 0.35% (WRMS)

### **General**

Power requirement: AC 120 V  $\sim$ , 60 Hz

Power consumption: 40 W (at operation)

2 W (on standby)

Dimensions (W/H/D) (approx.):

152 mm x 233 mm x 292 mm

(6 in. x 9 <sup>3</sup>/<sub>16</sub> in. x 11 <sup>1</sup>/<sub>2</sub> in.)

Mass (approx.): 3.9 kg (8.6 lbs)

### **Supplied accessories**

See page 6.

## **Speaker Section—SP-FSH300**

Type: Full range, bass-reflex type

Speakers: 10 cm cone x 1

Power handling capacity: 20 W

Impedance: 4  $\Omega$

Frequency range: 100 Hz—15 kHz

Dimensions (W/H/D) (approx.):

147 mm x 233 mm x 189 mm

(5 <sup>13</sup>/<sub>16</sub> in. x 9 <sup>3</sup>/<sub>16</sub> in. x 7 <sup>1</sup>/<sub>2</sub> in.)

Mass (approx.): 1.9 kg (4.2 lbs) each



# LIMITED WARRANTY

AUDIO-1

JVC COMPANY OF AMERICA warrants this product and all parts thereof, except as set forth below ONLY TO THE ORIGINAL PURCHASER AT RETAIL to be FREE FROM DEFECTIVE MATERIALS AND WORKMANSHIP from the date of original retail purchase for the period as shown below. ("The Warranty Period")

PARTS	<b>1 YR</b>	LABOR	<b>1 YR</b>
-------	-------------	-------	-------------

THIS LIMITED WARRANTY IS VALID ONLY IN THE FIFTY (50) UNITED STATES, THE DISTRICT OF COLUMBIA AND IN COMMONWEALTH OF PUERTO RICO.

**WHAT WE WILL DO:**

If this product is found to be defective, JVC will repair or replace defective parts at no charge to the original owner. Such repair and replacement services shall be rendered by JVC during normal business hours at JVC authorized service centers. Parts used for replacement are warranted only for the remainder of the Warranty Period. All products and parts thereof may be brought to a JVC authorized service center on a carry-in basis except for Television sets having a screen size 25 inches and above which are covered on an in-home basis.

**WHAT YOU MUST DO FOR WARRANTY SERVICE:**

Return your product to a JVC authorized service center with a copy of your bill of sale. For your nearest JVC authorized service center, please call toll free: (800) 537-5722.

If service is not available locally, box the product carefully, preferably in the original carton, and ship, insured, with a copy of your bill of sale plus a letter of explanation of the problem to the nearest JVC Factory Service Center, the name and location of which will be given to you by the toll-free number.

If you have any questions concerning your JVC Product, please contact our Customer Relations Department.

**WHAT IS NOT COVERED:**

This limited warranty provided by JVC does not cover:

1. Products which have been subject to abuse, accident, alteration, modification, tampering, negligence, misuse, faulty installation, lack of reasonable care, or if repaired or serviced by anyone other than a service facility authorized by JVC to render such service, or if affixed to any attachment not provided with the products, or if the model number or serial number has been altered, tampered with, defaced or removed;
2. Initial installation and installation and removal for repair;
3. Operational adjustments covered in the Owner's Manual, normal maintenance, video and audio head cleaning;
4. Damage that occurs in shipment, due to act of God, and cosmetic damage;
5. Signal reception problems and failures due to line power surge;
6. Video Pick-up Tubes/CCD Image Sensor, Cartridge, Stylus (Needle) are covered for 90 days from the date of purchase;
7. Accessories
8. Batteries (except that Rechargeable Batteries are covered for 90 days from the date of purchase);

There are no express warranties except as listed above.

THE DURATION OF ANY IMPLIED WARRANTIES, INCLUDING THE IMPLIED WARRANTY OF MERCHANTABILITY, IS LIMITED TO THE DURATION OF THE EXPRESS WARRANTY HEREIN.

JVC SHALL NOT BE LIABLE FOR THE LOSS OF USE OF THE PRODUCT, INCONVENIENCE, LOSS OR ANY OTHER DAMAGES, WHETHER DIRECT, INCIDENTAL OR CONSEQUENTIAL (INCLUDING, WITHOUT LIMITATION, DAMAGE TO TAPES, RECORDS OR DISCS) RESULTING FROM THE USE OF THIS PRODUCT, OR ARISING OUT OF ANY BREACH OF THIS WARRANTY. ALL EXPRESS AND IMPLIED WARRANTIES, INCLUDING THE WARRANTIES OF MERCHANTABILITY AND FITNESS FOR PARTICULAR PURPOSE, ARE LIMITED TO THE WARRANTY PERIOD SET FORTH ABOVE.

Some states do not allow the exclusion of incidental or consequential damages or limitations on how long an implied warranty lasts, so these limitations or exclusions may not apply to you. This warranty gives you specific legal rights and you may also have other rights which vary from state to state.

**JVC COMPANY OF AMERICA**                      1700 Valley Road  
 DIVISION OF JVC AMERICAS CORP.            Wayne, NJ 07470

REFURBISHED PRODUCTS CARRY A SEPARATE WARRANTY, THIS WARRANTY DOES NOT APPLY. FOR DETAILS OF REFURBISHED PRODUCT WARRANTY, PLEASE REFER TO THE REFURBISHED PRODUCT WARRANTY INFORMATION PACKAGED WITH EACH REFURBISHED PRODUCT.

**For customer use:**

Enter below the Model No. which is located either on the rear, bottom or side of the cabinet. Retain this information for future reference.

Model No. : \_\_\_\_\_ Serial No. : \_\_\_\_\_

Purchase data : \_\_\_\_\_ Name of dealer : \_\_\_\_\_

# Authorized Service Centers

---

QUALITY **JVC**<sup>®</sup> SERVICE  
*HOW TO LOCATE YOUR JVC SERVICE CENTER*  
**TOLL FREE: 1 (800) 537-5722**  
**<http://www.jvc.com>**

Dear Customer,

In order to receive the most satisfaction from your purchase, please read the instruction booklet before operating the unit. In the event that repairs are necessary, please call 1 (800)537-5722 for your nearest authorized servicer or visit our website at **[www.JVC.com](http://www.JVC.com)**

Remember to retain your Bill of Sale for Warranty Service.

---

**Do not service the television yourself**

---

## **Caution**

To prevent electrical shock, do not open the cabinet. There are no user serviceable parts inside. Please refer to qualified service personnel for repairs.

## **Accessories**

To purchase accessories for your JVC product, please call toll free: 1 (800)882-2345 or on the web at **[www.JVC.com](http://www.JVC.com)**

---

# MEMO

---

A series of horizontal dashed lines for writing.

# MEMO

---

A series of horizontal dashed lines for writing.

