

JVC®

I'Art™ PALETTE

Plasma Display Users Guide

**For Model:
PD-42WX84**

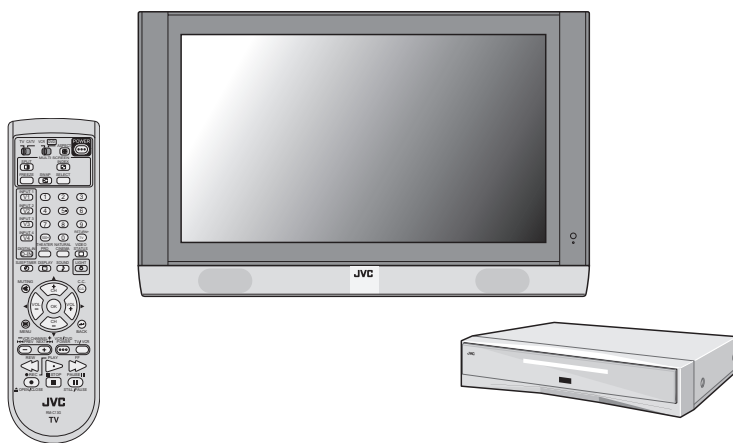

Illustration of PD-42WX84 and RM-C13G

Important Note:

In the spaces below, enter the model and serial number of your television (located at the rear of the television cabinet). Staple your sales receipt or invoice to the inside cover of this guide. Keep this user's guide in a convenient place for future reference. Keep the carton and original packaging for future use.

Model Number: _____

Serial Number: _____

LCT1480-001A
0803-KT-CR-VP

Important Safety Precautions



CAUTION
RISK OF ELECTRIC SHOCK
DO NOT OPEN



CAUTION: To reduce the risk of electric shock. Do not remove cover (or back). No user serviceable parts inside. Refer servicing to qualified service personnel.



The lightning flash with arrowhead symbol, within an equilateral triangle is intended to alert the user to the presence of uninsulated “dangerous voltage” within the product’s enclosure that may be of sufficient magnitude to constitute a risk of electric shock to persons.



The exclamation point within an equilateral triangle is intended to alert the user to the presence of important operating and maintenance (servicing) instructions in the literature accompanying the appliance.

WARNING: TO PREVENT FIRE OR SHOCK HAZARDS, DO NOT EXPOSE THIS TV SET TO RAIN OR MOISTURE.

CAUTION:

TO INSURE PERSONAL SAFETY, OBSERVE THE FOLLOWING RULES REGARDING THE USE OF THIS UNIT.

1. Operate only from the power source specified on the unit.
2. Avoid damaging the AC plug and power cord.
3. Avoid Improper installation and never position the unit where good ventilation is unattainable.
4. Do not allow objects or liquid into the cabinet openings.
5. In the event of trouble, unplug the unit and call a service technician. Do not attempt to repair it yourself or remove the rear cover.

Changes or modifications not approved by JVC could void the warranty.

- * When you don't use this TV set for a long period of time, be sure to disconnect both the power plug from the AC outlet and antenna for your safety.
- * To prevent electric shock do not use this polarized plug with an extension cord, receptacle or other outlet unless the blades can be fully inserted to prevent blade exposure.



- As an "ENERGY STAR®" partner, JVC has determined that this product or product model meets the "ENERGY STAR®" guidelines for energy efficiency.

Important Safeguards

CAUTION:

Please read and retain for your safety.

Electrical energy can perform many useful functions. This TV set has been engineered and manufactured to assure your personal safety. But **improper use can result in potential electrical shock or fire hazards**. In order not to defeat the safeguards incorporated in this TV set, observe the following basic rules for its installation, use and servicing. Also follow all warnings and instructions marked on your TV set.

INSTALLATION

- 1 Operate the TV set only from a power source as indicated on the TV set or refer to the operating instructions for this information. If you are not sure of the type of power supply to your home, consult your TV set dealer or local power company. For battery operation, refer to the operating instructions.
- 2 Overloaded AC outlets and extension cords are dangerous, and so are frayed power cords and broken plugs. They may result in a shock or fire hazard. Call your service technician for replacement.
- 3 Do not allow anything to rest on or roll over the power cord, and do not place the TV set where power cord is subject to traffic or abuse. This may result in a shock or fire hazard.
- 4 Do not use this TV set near water — for example, near a bathtub, washbowl, kitchen sink, or laundry tub, in a wet basement, or near swimming pool, etc.
- 5 Avoid improper installation and never position the unit where good ventilation is impossible. When installing this TV, distance recommendations must be maintained between the set and the wall, as well as inside a tightly enclosed area or piece of furniture. Keep to the minimum distance guidelines shown for safe operation.

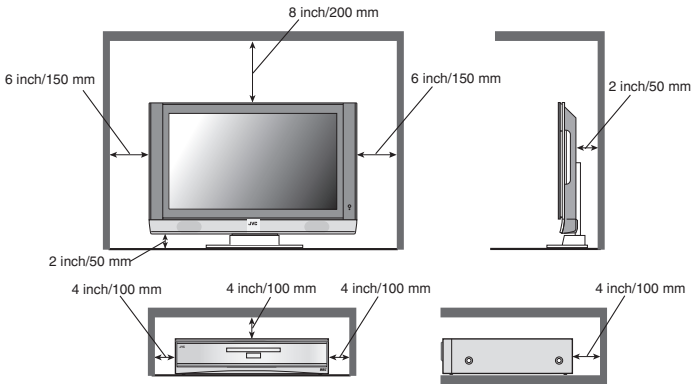

6 Cautions for installation

- Do not tilt the TV towards the left or right, or towards the back.
 - Install the TV in a corner on a wall or on the floor so as to keep cords out of the way.
 - The TV will generate a slight amount of heat during operation. Ensure that sufficient space is available around the TV to allow satisfactory cooling.
 - The ambient temperature for using this TV is 0° to 40°C (32° to 104°F). Using the TV outside of this range may lead to it not working correctly or being broken.
- 7 If an outside antenna is connected to the TV set, be sure the antenna system is grounded so as to provide some protection against voltage surges and built-up static charges. Section 810 of the National Electrical Code provides information with respect to proper grounding of the mast and supporting structure, grounding of the lead-in wire to an antenna discharge unit, size of grounding conductors, location of antenna discharge unit, connection requirements for the grounding electrode.

- 8 An outside antenna system should not be located in the vicinity of overhead power lines or other electric light or power circuits, or where it can fall into such power lines or circuits. When installing an outside antenna system, extreme care should be taken to keep from touching such power lines or circuits as contact with them might be fatal.

EXAMPLE OF ANTENNA GROUNDING AS PER NATIONAL ELECTRICAL CODE

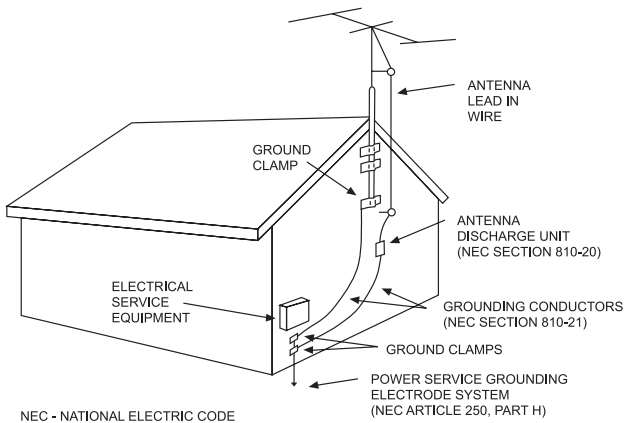

- 9 TV sets are provided with ventilation openings in the cabinet to allow heat generated during operation to be released.

Therefore:

- Never block the bottom ventilation slots of a portable TV set by placing it on a bed, sofa, rug, etc.
 - Never place a TV set in a “built-in” enclosure unless proper ventilation is provided.
 - Never cover the openings with a cloth or other material.
 - Never place the TV set near or over a radiator or heat register.
- 10 To avoid personal injury:
- Do not place a TV set on a sloping shelf unless properly secured.
 - Use only a cart or stand recommended by the TV set manufacturer.
 - Do not try to roll a cart with small casters across thresholds or deep pile carpets.
 - Wall or shelf mounting should follow the manufacturer’s instructions, and should use a mounting kit approved by the manufacturer.

Use

- 11 Caution children about dropping or pushing objects into the TV set through cabinet openings. Some internal parts carry hazardous voltages and contact can result in a fire or electrical shock.
- 12 Unplug the TV set from the wall outlet before cleaning. Do not use liquid or an aerosol cleaner.
- 13 Never add accessories to a TV set that has not been designed for this purpose. Such additions may result in a hazard.



PORTABLE CART WARNING
(Symbol provided by RETAC)

- 14 For added protection of the TV set during a lightning storm or when the TV set is to be left unattended for an extended period of time, unplug it from the wall outlet and disconnect the antenna. This will prevent damage to product due to lightning storms or power line surges.
- 15 A TV set and cart combination should be moved with care. Quick stops, excessive force, and uneven surfaces may cause the TV set and cart combination to overturn.

Service

- 16 Unplug this TV set from the wall outlet and refer servicing to qualified service personnel under the following conditions:
 - A. When the power cord or plug is damaged or frayed.
 - B. If liquid has been spilled into the TV set.
 - C. If the TV set has been exposed to rain or water.
 - D. If the TV set does not operate normally by following the operating instructions.
Adjust only those controls that are covered in the operating instructions as improper adjustment of other controls may result in damage and will often require extensive work by a qualified technician to restore the TV set to normal operation.
 - E. If the TV set has been dropped or damaged in any way.
 - F. When the TV set exhibits a distinct change in performance — this indicates a need for service.
- 17 Do not attempt to service this TV set yourself as opening or removing covers may expose you to dangerous voltage or other hazards. Refer all servicing to qualified service personnel.
- 18 When replacement parts are required, have the service technician verify in writing that the replacement parts he uses have the same safety characteristics as the original parts. Use of manufacturer's specified replacement parts can prevent fire, shock, or other hazards.
- 19 Upon completion of any service or repairs to this TV set, please ask the service technician to perform the safety check described in the manufacturer's service literature.
- 20 When a TV set reaches the end of its useful life, improper disposal could result in a picture tube implosion. Ask a qualified service technician to dispose of the TV set.
- 21 Note to CATV system installer.
This reminder is provided to call the CATV system installer's attention to Article 820-40 of the NEC that provides guidelines for proper grounding and, in particular, specifies that the cable ground shall be connected to the grounding system of the building, as close to the point of cable entry as practical.

WARNING

Burn-in

A characteristic of Plasma Display Panels (PDPs) is that displaying the same image for a long time causes a part of the image to stay on the screen (this is called phosphor burn-in).

Avoid burn-in as follows.

IMAGE SHIFT

The picture displayed on the screen is shifted up, down and to the left and right at regular intervals. In order to prevent burn-in, set this function to FAST or STD. (Refer to page 45.)

Even if the IMAGE SHIFT function is turned off, the picture will shift to the left or right when the channel or input is changed. This is only when the ASPECT function is in REGULAR mode.

VIDEO STATUS

The VIDEO STATUS function is initially set to DYNAMIC. Unless the TV is being watched in an extremely bright room, it is recommended to change the VIDEO STATUS setting to standard, theater or game. Doing so will reduce the chance of PDP burn-in and extend the life of the PDP. (Refer to page 58).

Do not display static images or characters for long periods of time.

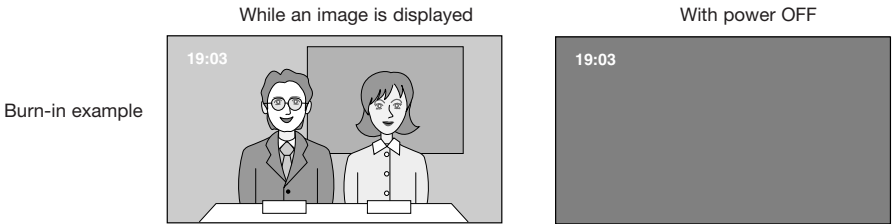

• Reduce PICTURE and BRIGHT on the PICTURE ADJUST menu (page 49) when viewing.

Do not view for long periods of time in the REGULAR mode (page 60).

Screen size is normally chosen to ensure that the picture is displayed on the entire screen. After viewing in the REGULAR mode in which black bands may occur at the left and right of the screen, it is recommended to change to the PANORAMA mode to display the picture on the entire screen.

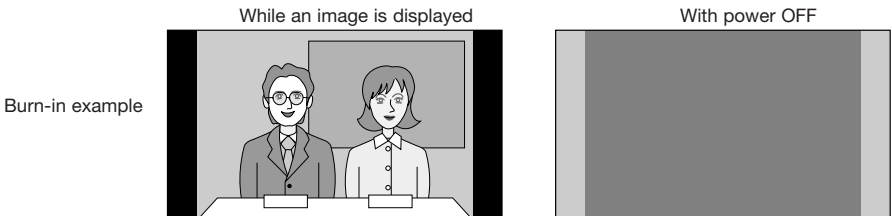

Do not view for long periods of time using the SPLIT function (page 54) or INDEX function (page 55).

WARNING

If Burn-in has occurred

If burn-in occurs, try the BURN-IN IMAGE REDUCER function (page 50). If burn-in is minimal it may gradually become less noticeable.

Note: Once burn-in occurs it will never disappear completely.

Point defects

PDPs use collections of fine pixels to display images. While there is no problem with more than 99.99% of these pixels, please understand that a very small number of pixels may not light or may light all the time.

Do not install the TV near electronic equipment that is susceptible to electromagnetic waves

It may cause interference in images, sound, etc. In particular, keep video equipment away from this product.

Effect on infrared devices

There may be interference while using infrared devices such as infrared cordless headphones.

The phenomenon described below is not a malfunction.

If the television is used at a location above an altitude of 2,000 m, a buzzing noise and image distortion may occur. This phenomenon is peculiar to PDP (Plasma Display Panel), and could occur with any television using PDP. It is not a malfunction.

Table of Contents

Quick Setup 10

Unpacking your TV	10
Attaching the stand to the TV	11
TV/Receiver	12
TV Remote Control	13
Getting Started	14
Set Up Your TV	14
The Remote Control	16
Connections	18
Connecting Your Devices	18
Plug-In Menu	25
The Interactive Plug In Menu	25

Remote Programming 28

Setting CATV, VCR and DVD Codes	28
Cable box or Satellite Codes	28
VCR Codes	29
DVD Codes	30
Search Codes	31

Onscreen Menus 32

Using the Guide	32
The Onscreen Menu System	33

Initial Setup 35

Auto Tuner Setup	35
Channel Summary	35
V-Chip	36
Set Lock Code	42
Auto Demo	43
Power Indicator	43
Position Adjustment	43
Digital-In	44
TV Speaker	44
Audio Out	45
Image Shift	45
Language	45
Closed Caption	46
Noise Muting	46
Front Panel Lock	47
V1 Smart Input	47
Auto Shut Off	48
XDS ID	48

Picture Adjust 49

Picture Settings	49
Adjust Picture Settings	49
Color Temperature	49
Digital Noise Clear	50
Color Management	50
Burn-in Image Reducer	50
Reset	50

Sound Adjust 51

Sound Settings	51
Adjust Sound Settings	51
MTS (Multi-Channel Television Sound)	51

Clock/Timers 52

Set Clock	52
On/Off Timer	53

Button Functions 54

Multi Screen Function	54
Split	54
Index	55
Freeze	55
Swap	55
Select	55
Power	56
Number Buttons	56
100+ Button	56
Input	56
Digital-In	56
Return +/TV	57
Sound	57
Muting	58
Video Status	58
Natural Cinema	58
TheaterPro D6500K	58
Sleep Timer	59
Display	59
Aspect	60
Aspect Ratios	60
C.C.	61
Menu	61
OK	61
Back	61
TV/CATV Slide Switch	62
VCR/DVD Slide Switch	62
VCR Buttons	62
DVD Buttons	62
Light	62

Appendices

Troubleshooting	65
Warnings	65
Warranty	66
Authorized Service Centers	68
Specifications	69

Quick Setup

Unpacking your TV

Thank you for your purchase of a JVC Color Television. Before you begin setting up your new television, please check to make sure you have all of the following items.



TV



Receiver

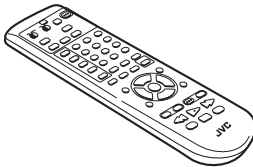

Remote control

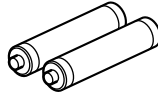

AA/R06-size batteries
(used to check operation)

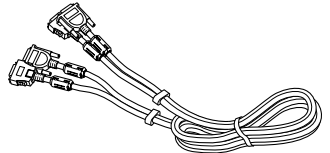

System cable

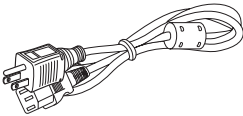

Power cord

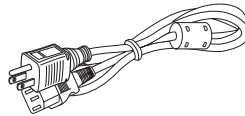

Ferrite core x 1



Screw (A) x 2



Screw (B) x 6



Screw (C) x 4

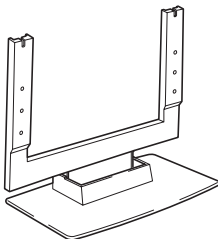

Stand x 1

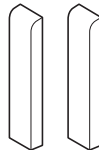

Cover x 2



Cable clamp x 1

Read the following instructions and then attach the supplied stand to the TV.

WARNING: The TV is heavy. It should always be carried by at least two people. Attempting to carry it by yourself may lead to it being dropped causing injuries and damage.

Required items: Phillips screwdriver

1. Attach the screws (A) to the back of the TV.

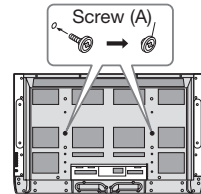

2. Attach the TV to the stand.

Insert the heads of the screws (A) into the top of the stand bar and temporarily secure the TV to the stand.

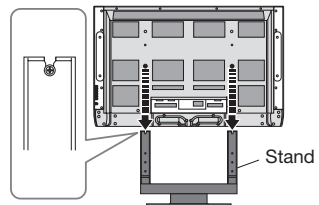

3. Secure the TV to the stand with the screws (B).

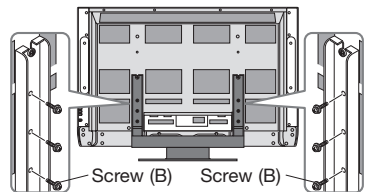

4. Insert the cover to the stand and fix with the screws (C).

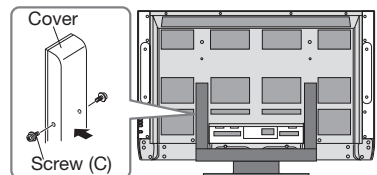

5. Remove the paper from the bottom of the cable clamp and attach the cable clamp to the stand.

- Clamp the system cable and power cord using the cable clamp after connecting the system cable and the power cord to the TV.

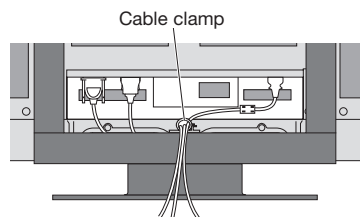

NOTE: Before you connect your receiver to another device, please refer to the proper diagrams for your specific TV and remote.

Display Front

Refer to the pages in parentheses for details.

- ① Remote control sensor
- ② Power lamp (page 17)
- ③ MENU ▼ button (pages 34)
- ④ INPUT button (page 56)
- ⑤ VOL (Volume) -/+ buttons
- ⑥ CH -/+ buttons (page 16)
- ⑦ POWER button

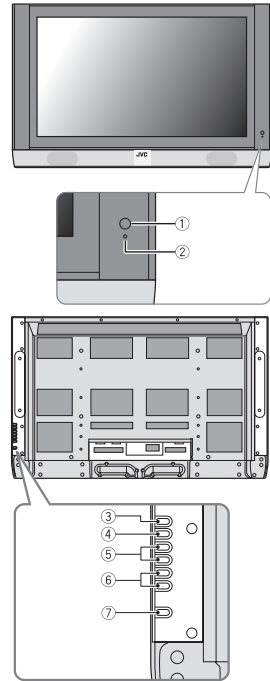

Receiver Front

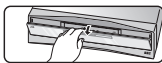

How to open the cover

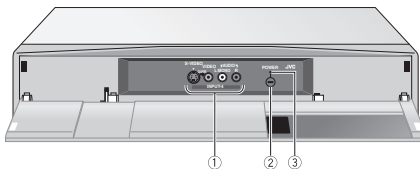

Refer to the pages in parentheses for details.

- ① INPUT-4 terminal (pages 22)
- ② POWER button (page 17)
- ③ Power lamp (page 17)

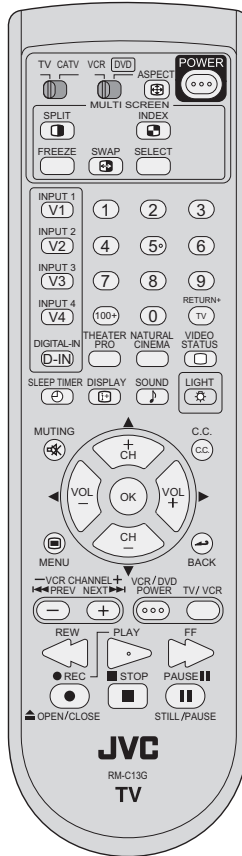

RM-C13G

- For information on remote control buttons, see pages 54-62.

Getting Started

These quick setup pages will provide you, in four easy steps, with the basic information you need to begin using your new television right away.

If you have questions, or for more detailed information on any of these steps, please consult other sections of this manual.

STEP 1 - Set Up Your TV

Caution

- Turn off all equipment (including the TV) before connecting anything.

Connection Diagram

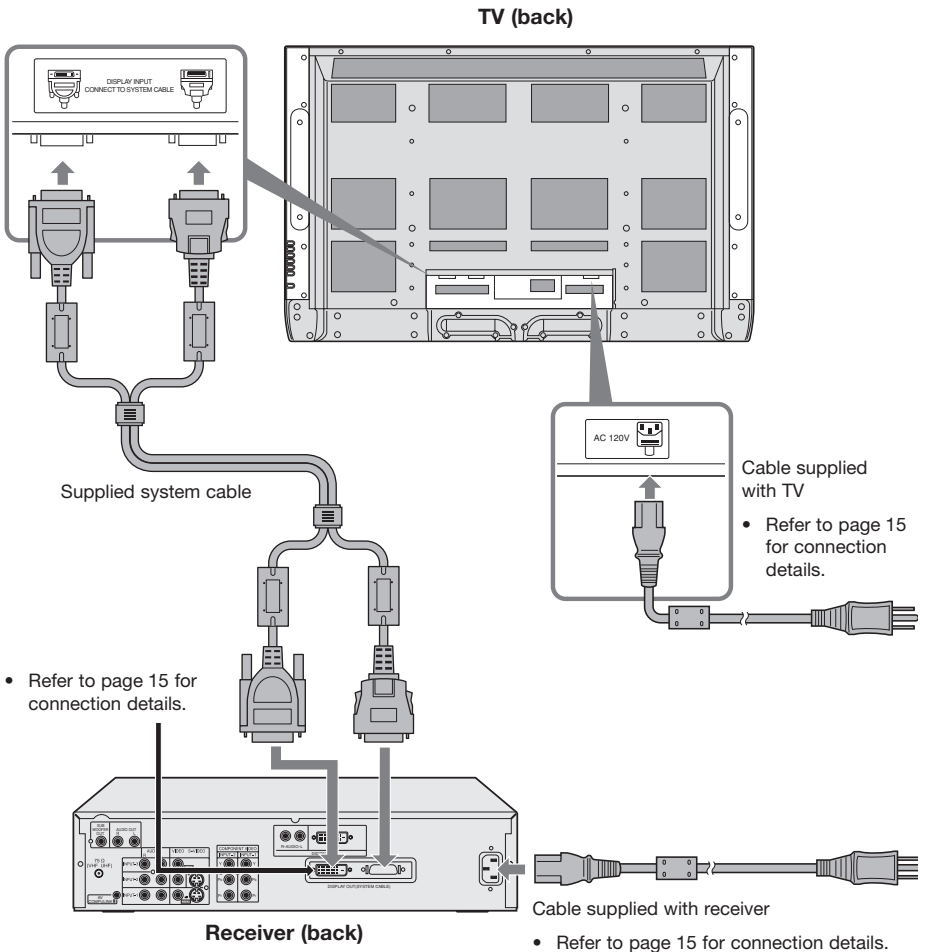

Connecting the TV and receiver

Use the supplied system cable to connect the TV to the receiver. The two connectors are of different shapes. Ensure that the pins on connector ① are oriented correctly, press the connector into the socket, and tighten the screws at left and right to lock it in place. Press connector ② firmly into place until it is locked.

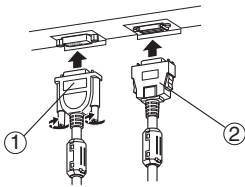

Disconnecting the system cable

Release connector ① by unscrewing the screws at left and right and removing it from the socket. Release connector ② by removing it from the socket while pressing the release bottoms on either side.

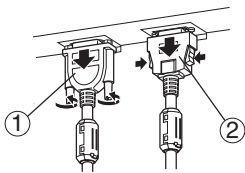

Connecting the power cord to the AC outlet

Insert the AC plugs on the power cords from the TV and receiver into AC outlets.

Caution

- Operate only from the power source specified (AC 120V, 60 Hz) on the unit.
- Failure to use the supplied power cord or to insert it into a correctly grounded outlet may result in electric shocks.

Use the supplied power cord which best suits the area in which you live.

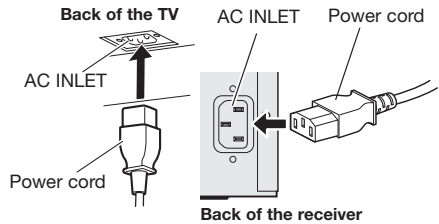

Insert the AC plug into a correctly grounded outlet.

- Remove the AC plug from the outlet to completely disconnect the TV from the power supply.

Receiver rear

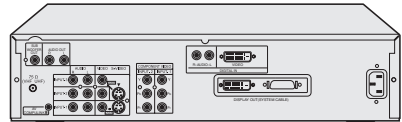

Step 2 – The Remote Control

Before you can operate your remote control, you first need to install the batteries (included).

Slide the cover on the back of the remote down towards the bottom of the remote control. Insert two batteries (included) carefully noting the “+” and “-” markings, placing the “-” end in the unit first. Slide the cover back into place.

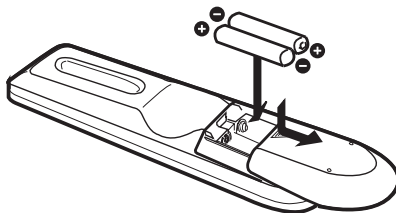

When you change the batteries, try to complete the task within three minutes. If you take longer than three minutes, the remote control codes for your VCR, DVD, and/or cable box/satellite receiver may have to be reset. See pages 28 - 31.

Key Feature Buttons

The four key feature buttons at the center of the remote can be used for basic operation of the television. The top and bottom buttons will scan forward and back through the available channels. To move rapidly through the channels using JVC's **Hyperscan** feature, press and hold CH+ or CH-. The channels will zip by at a rate of five channels per second. The right and left buttons will turn the volume up or down. These buttons are also marked with four arrows and are used with JVC's onscreen menu system. To use the onscreen menus, press the MENU button.

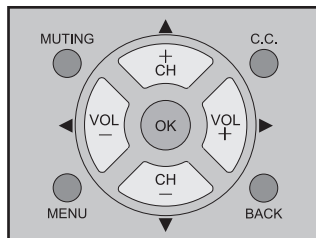

Basic Operation

Turn the television on and off by pressing the POWER button at the top right corner of the remote. If this is the first time you are turning on the TV, the interactive plug-in menu appears.

- Turn on the TV after connecting it to the other surrounding devices. (Refer to page 18.)
- Make sure the TV/CATV switch is set to TV. Move the switch to CATV only if you need to operate a cable box.
- Slide the VCR/DVD selector switch to VCR to control a VCR. Slide to DVD to control a DVD player. Please see pages 28 to 31 for instructions on programming your remote control to operate a cable box, VCR or DVD player.

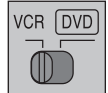
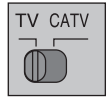
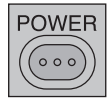

Display front

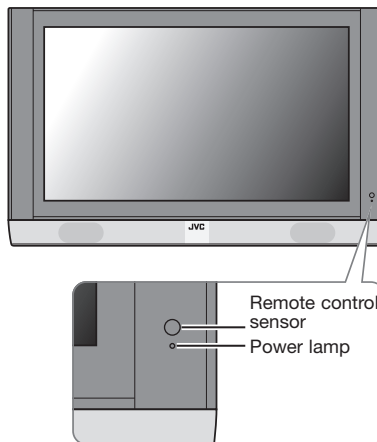

Receiver front

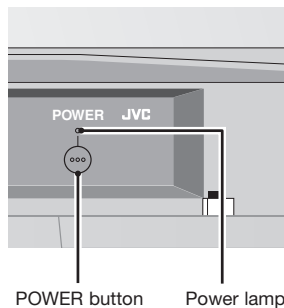

- When the TV is off, the TV and TUNER power lamps do not light. When the TV is on, the TV and TUNER power lamps light. However, when the POWER INDICATOR in the MENU is set to OFF, the power lamps do not light even when the TV is on. (Refer to “POWER INDICATOR” on page 43)

Step 3 – Connecting Your Devices

To make these connections, you will use plugs like the ones illustrated below.

Coaxial Cables

Ferrite core (accessory)

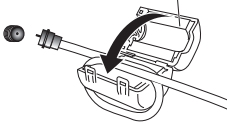

Used to connect an external antenna or cable TV system to your receiver.

Attach the ferrite core to the coaxial cable. Using it without the ferrite core may lead to noise (interference).

- Attach the ferrite core as close to the receiver as possible.

Component Cables Composite Cables Audio Cables

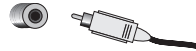

Used to connect audio/video devices like VCRs, DVD players, stereo amplifiers, game consoles, etc.

S-Video Cable



Used to make video connections with S-Video VCRs, Camcorders and DVD players.

Please follow the flow chart below to determine which connection setup is right for you. Then, refer to the appropriate diagrams to connect your receiver to other devices that you may have. After you are finished connecting your devices, plug the power cord into the nearest power outlet and turn on the TV.

A VCR is not necessary for operation of the television. If you follow these diagrams and the television does not work properly, contact your local cable operator.

- To connect a DVD player, see **Diagram #3**. A DVD player is optional.
- If you have a satellite television system, please refer to the satellite TV manual.

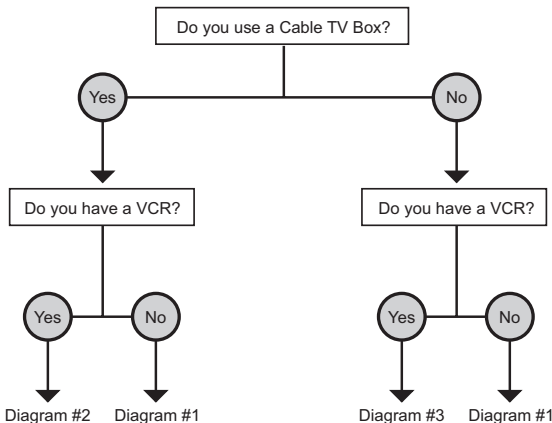
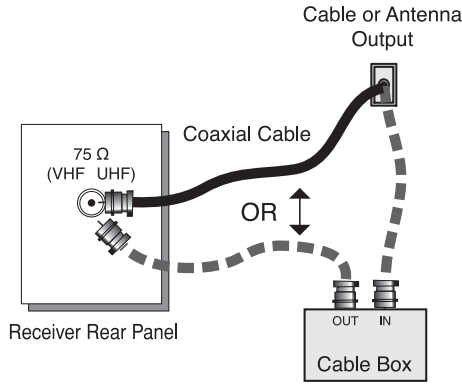

Diagram #1



Note:

- If you do not have a cable box, connect the cable wire from the wall outlet into the back of the receiver.

Diagram #2

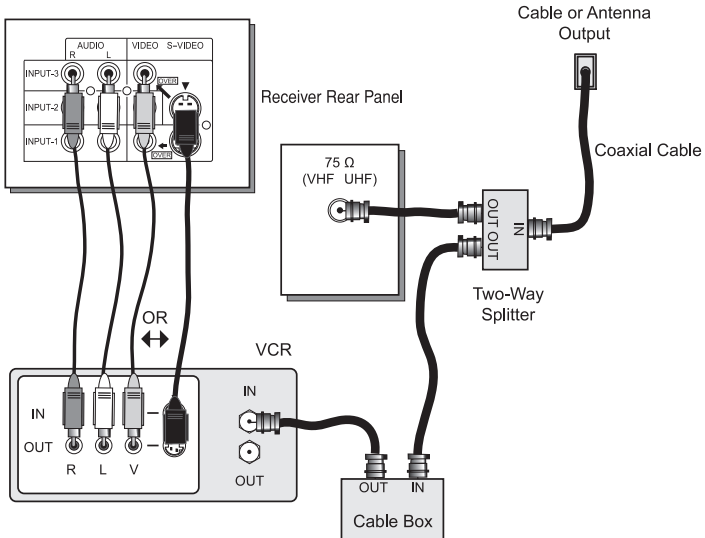

Notes:

- Use the S-Video connection if possible for superior picture quality.
- Your VCR must be turned on to view premium cable channels.

Notes:

- Green, blue and red are the most common colors for DVD cables. Some models may vary colors. Please consult the user's manual for your DVD player for more information.
- Be careful not to confuse the red DVD cable with the red audio cable. It is best to complete one set of connections (DVD or audio output) before starting the other to avoid accidentally switching the cables.
- You may also connect the DVD player to Input 1.

Diagram #3

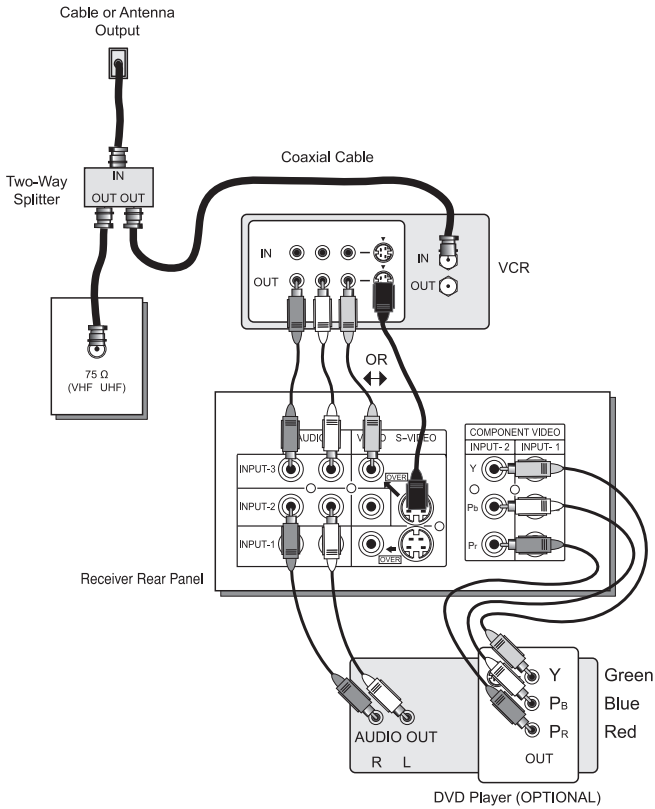

Connecting to JVC AV Compu Link

JVC's AV compu link feature makes playing video tapes or DVDs totally automatic. Simply insert a pre-recorded tape into your JVC brand VCR or DVD into your JVC DVD player and the device will automatically turn on and begin playback. At the same time, using the AV compu link, the VCR or DVD player sends a signal to the television telling it to turn on and switch to the proper video input.

- The AV compu link cable may be included with the JVC AV compu link unit you wish to connect. If it is not, contact JVC Parts Department at (800)-882-2345, or www.jvcservice.com for part # EWP 805-012.
- AV Compu Link can only be used with JVC brand products.

AV Compu Link Cable



To Connect: Plug one end of the AV compu link cable into the AV COMPU LINK INPUT on your VCR, DVD, or other compu link device. Plug the other end of the AV compu link cable into the AV COMPU LINK at the rear of the receiver.

Note:

- The AV compu link cable has a male 3.5 mm (mono) plug on each end.

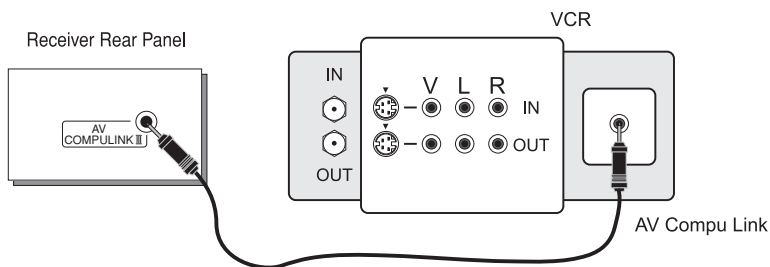

Notes:

- In order for the VCR playback to begin automatically, the recording tabs must be removed from the VHS tape. If the tab is in place, automatic switching will occur when you push the VCR's PLAY button.
- If your JVC brand VCR has "A code/B code remote control switching" (see your VCR's instruction book), using VCR A code will switch the TV to input 1.
- Refer to your DVD instruction book for detailed connection information.
- To connect a JVC HiFi receiver or amplifier for a completely automated home theater, see the receiver connection instructions for detailed connection information.
- AV compu link is compatible with select AV compu link receivers.

Connecting to a Camcorder

You may connect a camcorder, game console or other equipment to your television by using the front input jacks (Input 4) located under the front panel door. To access, pull on the door to open it. You can also connect these using the television's rear input jacks, using the same instructions.

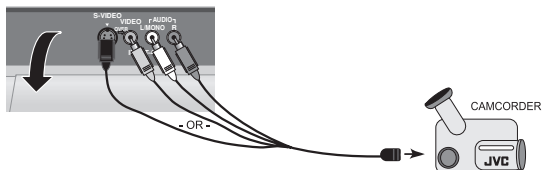

- 1) Connect a yellow composite cable from the camcorder VIDEO OUT, into the VIDEO IN on the front of the receiver, **OR** connect an S-Video cable from the front of the receiver to the camcorder.
- 2) Connect a white composite cable from the camcorder LEFT AUDIO OUT, into the LEFT AUDIO IN on the front of the receiver.
- 3) Connect a red composite cable from the camcorder RIGHT AUDIO OUT, into the RIGHT AUDIO IN on the front of the receiver.

Note:

- If your camcorder is a mono sound model it will have only one AUDIO OUT. Connect it to the LEFT AUDIO IN on the front of the receiver.

Connecting to an External Amplifier

Subwoofer Out - Use a powered subwoofer with the surround feature to simulate a home theater system. Simply connect the subwoofer to the back of the receiver.

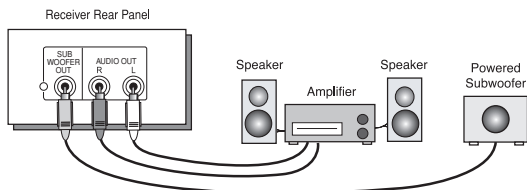

- 1) Connect a white composite cable from the LEFT AUDIO OUTPUT on the back of the receiver to the LEFT AUDIO INPUT on the amplifier.
- 2) Connect a red composite cable from the RIGHT AUDIO OUTPUT on the back of the receiver to the RIGHT AUDIO INPUT on the amplifier.
- 3) Connect a black composite cable from the SUBWOOFER OUT on the back of the receiver to the LINE INPUT of the subwoofer.

Notes:

- Refer to your amplifier's manual for more information.
- You can use AUDIO OUTPUT for your home theater system.

Connecting to a Digital TV Receiver w/HDCP

By inputting a high bandwidth digital content protection high definition picture source to the digital-in terminal of this television, high-definition pictures can be displayed on the screen in their digital form. (This terminal is for use in the future when high bandwidth digital content protection DTV decoders and DVD players and D-VHS are put on the market.)

After the connections have been made, tighten the screw to secure the cables.

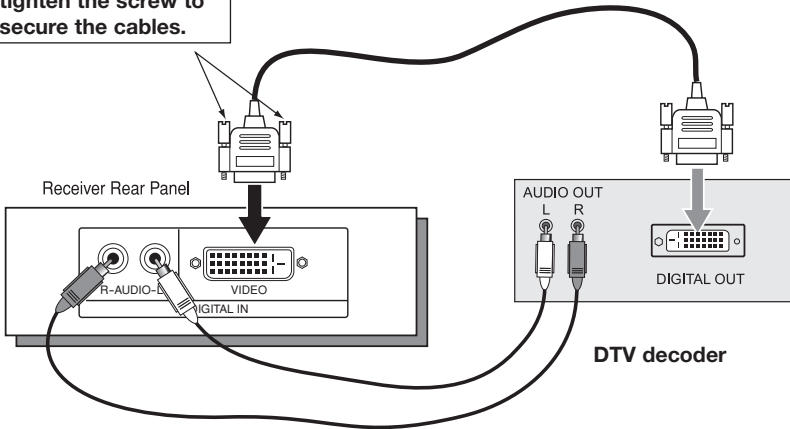

- 1) Connect the DTV DIGITAL RGB OUTPUT TERMINAL to the DIGITAL INPUT TERMINAL of the receiver, and then tighten the 2 screws.
 - 2) Connect the DTV decoder LEFT AUDIO OUTPUT to the DIGITAL-IN LEFT AUDIO INPUT.
 - 3) Connect the DTV decoder RIGHT AUDIO OUTPUT to the DIGITAL-IN RIGHT AUDIO INPUT.
- The Digital-In terminal can only be used with 1080i, 720p and 480p picture signals. Set the DTV decode digital-out terminal output setting to 1080i, 720p or 480p. For detailed information, refer to the DTV decoder instruction manual. If you can not display the picture because your DTV decoder does not have a digital-out terminal output setting, use the component video input (or the S-Video input or video input). Refer to page 20. In this case the picture will be displayed as an analog signal.
 - The digital-in terminal is not compatible with the picture signal of a personal computer.
 - Use a DVI-D single link 19-pin cable (commercially available) in order to digitally connect the receiver with a DTV decoder.

If 480p signals (640x480 or 720x480) are displayed on the screen, the horizontal balance may be slightly shifted. In cases such as this, the horizontal balance can be adjusted by accessing "DIGITAL-IN" in the INITIAL SETUP menu. (Refer to page 44.)

Connecting to an AV Receiver using your television's V1 Smart Input

By connecting your AV Receiver to your television's V1 smart Input, you can watch picture sources from many different devices, without having to change or use the other input connections on your TV. This allows you to free up other input connections so you can connect more devices to your television.

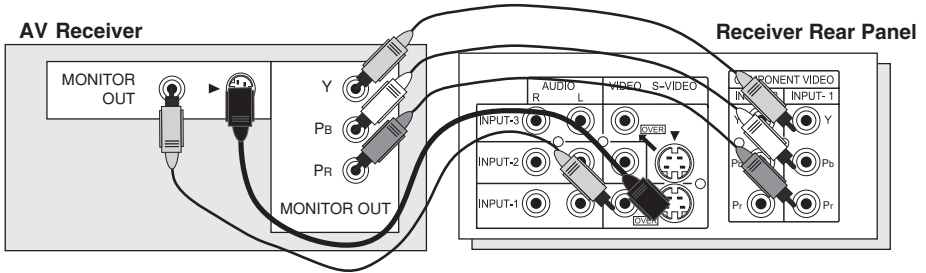

- 1) Connect an S-Video Cable from the AV Receiver's MONITOR OUT, to the S-Video INPUT-1 on the back of your receiver.
- 2) Connect a Yellow Component Cable from the AV Receiver's MONITOR OUT, into the VIDEO INPUT-1 on the back of your receiver.
- 3) Connect a Green Component Cable from the AV Receiver's Y MONITOR OUT, into the Y VIDEO INPUT-1 on the back of your receiver.
- 4) Connect a Blue Component Cable from the AV Receiver's Pb MONITOR OUT, into the Pb VIDEO INPUT-1 on the back of your receiver.
- 5) Connect a Red Component Cable from the AV Receiver's Pr MONITOR OUT, into the Pr VIDEO INPUT-1 on the back of your receiver.

Notes:

- Please refer to your AV Receiver instruction manual for more information on connecting your speakers and other devices like a DVD player.
- Use your AV Receiver's remote to switch to the different devices you have connected.
- Some AV Receiver's may not respond when the V1 Smart Input function is turned on.
- If you have video connections for each input device connected to your AV Receiver, you should not connect them using both S-Video and Composite connection at the same time when you are using V1 input as the V1 Smart Input. In this case we recommend using the S-Video connection.

Step 4 – The Interactive Plug In Menu

When you turn your television on for the first time the interactive plug-in menu will appear. The plug-in menu helps you to get your TV ready to use by letting you set your preferences for:

- The language in which you want the onscreen menus to appear.
- Setting the TV's clock to the correct time so your timer functions will work properly. You can choose "AUTO" or "MANUAL" for setting the clock.
- The auto tuner setup of which channels you wish to receive.

We recommend you complete the interactive plug-in items before you start using your television.

Language

After the "JVC INTERACTIVE PLUG IN MENU" has been displayed, the TV automatically switches to the LANGUAGE settings. You can choose to view your onscreen menus in three languages: English, French (Français) or Spanish (Español).

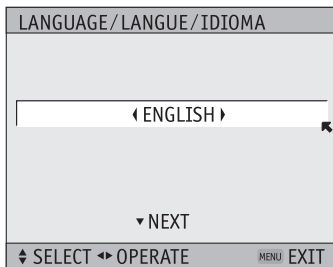

To choose a language:
(English, Français or Español)



To NEXT (To set clock)

(To be continued...)

Auto Clock Set

Before you use any of your TV's timer functions, you must first set the clock. You may precisely set your clock using the XDS time signal broadcast by most public broadcasting stations. If you do not have this in your area, you will have to set the clock manually. See manual clock set below. To set the clock using the XDS signal:

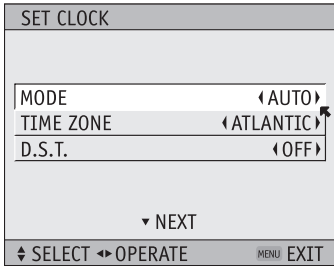

- ◀▶ To choose AUTO
- ▼ To TIME ZONE
- ◀▶ To select your time zone: (Atlantic, Eastern, Central, Mountain, Pacific, Alaska or Hawaii)
- ▼ To move to D.S.T. (Daylight Savings Time)
- ◀▶ To turn D.S.T. ON or OFF
- ▼ To NEXT (To Auto Tuner Setup)

Notes:

- The Daylight Savings Time feature automatically adjusts your TV's clock for Daylight Savings. The clock will move forward one hour at 2:00 am on the first Sunday in April. The clock will move back one hour at 2:00 am on the last Sunday in October.
- You will have to reset the clock after a power interruption. You must set the clock before operating any timer functions.

Manual Clock Set

To set your clock manually (without using the XDS signal), choose MANUAL. If you choose AUTO, see auto clock set above.

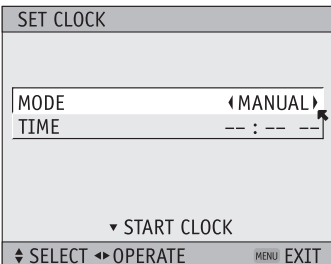

- ◀▶ To choose MANUAL
- ▼ To TIME
- ◀▶ To set the hour
- ▼ To minute
- ◀▶ To set the minute
- ▼ To Start Clock

Note:

- You will have to reset the clock after a power interruption. You must set the clock before operating any timer functions.

(To be continued...)

Auto Tuner Setup

In auto tuner setup, the TV automatically scans through all available channels, memorizing the active ones and skipping over blank ones or channels with weak signals. This means when you scan (using the CHANNEL +/- buttons) you will receive only clear, active channels.

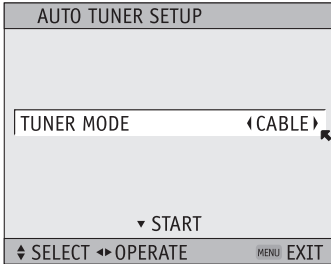

To choose CABLE or AIR (or SKIP when you skip Auto Tuner Setup)
To START



**Programming will take approximately
1 to 2 minutes.**

When the setup is finished, THANK YOU!! SETUP IS NOW COMPLETE is displayed. Your quick setup is now complete. You can now begin watching your television, or you can continue on in this guide for more information on programming your remote control, or using the JVC onscreen menu system to customize your television viewing experience.

Notes:

- Noise muting will not work during Auto Tuner Setup.
- Skip appears only for interactive plug-in menu.
- The interactive plug-in menu setting does not appear if your TV has been turned on before. In this case, use the menu to perform these settings. See pages 45, 52 and 35.

Cable Box and Satellite Users: After your auto tuner setup is complete, you may, (depending on the type of hookup), have only 1 channel, usually 3 or 4 in the auto tuner memory. This is normal.



The Quick Setup is complete

Remote Programming

Setting the CATV, VCR and DVD Codes

You can program your remote to operate your cable box, satellite receiver, VCR or DVD player by using the instructions and codes listed below. If the equipment does not respond to any of the codes listed below or to the code search function, use the remote control supplied by the manufacturer.

Cable Box or Satellite Codes

The remote control is programmed with cable box and satellite codes for power on/off, channel up/down, and 10 key operation.

- 1) Find the cable box or satellite brand from the list of codes shown below.
 - 2) Slide the 2-way selector switch to "CATV".
 - 3) Press and hold down the DISPLAY button, then enter the first code number listed with the 10 key pad.
 - 4) Release the DISPLAY button, and confirm the operation of the cable box/satellite receiver.
- If your cable or satellite box does not respond to the first code, try the others listed. If it does not respond to any code, try the search codes function, on page 31.

Cable Box	CODES	Cable Box	CODES	Digital Satellite Systems	CODES
ABC	024	Puser	032	Echostar (Dish Network)	100, 113, 114, 115
Archer	032, 025	RCA	061, 070		
Cableview	051, 032	Realistic	032		
Citizen	022, 051	Regal	058, 064, 040, 041, 042, 045, 068		
Curtis	058, 059				
Diamond	024, 032, 025	Regency	034		
Eagle	029	Rembrandt	037, 032, 051, 038		
Eastern	034				
GC Brand	032, 051	Samsung	051		
Gemini	022, 043	Scientific Atlanta	057, 058, 059		
General Instrument/Jerrold	065, 024, 025, 026, 027, 020, 021, 022, 057, 023, 072, 074	SLMark	051, 047		
		Sprucer	051, 056		
		Stargate	032, 051		
		Telecaption	067		
Hamlin	040, 041, 042, 045, 058, 064	Television	047, 051		
Hitachi	049, 024	Texscan	044		
Macom	049, 050, 051, 054	Tocom	035, 036, 066, 074		
Magnavox	033				
Memorex	030	Toshiba	050, 048		
Movietime	032, 051	Unika	032, 025		
Oak	039, 037, 048	Universal	022, 032		
Panasonic	055, 056, 060, 071, 073	Videoway	052		
Paragon	063	Viewstar	029, 030		
Philips	028, 029, 030, 052, 053, 031, 069	Zenith	063, 046		
		Zenith/Drake Satellite	046		
Pioneer	047, 062				
Pulsar	051, 032				
				Gradiente	112
				G.I.	108, 120, 121, 122
				Hitachi	104, 111
				HNS (Hughes)	104
				Magnavox	102, 103
				Panasonic	105
				Philips	102, 103, 116
				Primostar	108
				Proscan	106, 109, 110
				RCA	106, 109, 110
				Sony	107
				Star Choice	104, 108
				Toshiba	101, 104, 117, 118, 119
				Uniden	102, 103

Remote Programming

VCR Codes

The remote control is programmed with VCR codes for power on/off, play, stop, fast-forward, rewind, pause, record, channel up/down operation.

- 1) Find the VCR brand from the list of codes shown below.
 - 2) Slide the first 2-way selector switch to "TV" and the other 2-way selector switch to "VCR".
 - 3) Press and hold down the DISPLAY button, then enter the first code number listed with the 10 key pad.
 - 4) Release the DISPLAY button, and confirm the operation of the VCR.
- If your VCR does not respond to the first code, try the others listed. If it does not respond to any of the codes, try the search codes function on page 31.
 - After you program your remote, some VCR buttons may not work properly. If so, use the VCR's remote.
 - To record, hold down the REC button on the remote and press PLAY.

VCRs	CODES	VCRs	CODES	VCRs	CODES
Admiral	035	Marantz	003, 004, 005	Samsung	037, 060, 062, 033, 089
Aiwa	027, 032, 095	Marta	064	Samtron	089
Akai	029, 072, 073, 074	Memorex	024, 067	Sansui	003, 026, 020, 052
Audio Dynamic	003, 005	MGA	038, 040, 047, 048, 041, 042	Sanyo	063, 067, 091, 071
Bell & Howell	063, 071	Minolta	058, 045, 093	Scott	059, 060, 062, 067, 038, 040, 047, 048, 026, 020
Broksonic	020, 026, 094	Mitsubishi	038, 040, 047, 048, 041, 042, 078, 090	Sears	063, 064, 065, 066, 058
Canon	023, 025	Multitech	047, 027, 062	Sharp	035, 036, 080, 088
CCE	043	NEC	003, 004, 005, 000	Shintom	075
Citizen	064	Olympic	024, 023	Signature 2000	027, 035
Craig	063, 029, 064	Optimus	028, 021, 035, 064	Singer	075
Curtis Mathes	045, 024, 027, 093	Orion	026, 020	Sony	028, 029, 030, 053, 054, 055
Daewoo	043, 059, 024, 092	Panasonic	023, 024, 021, 022	SV 2000	027
DBX	003, 004, 005	Penney	024, 058, 045, 063, 003, 004, 005, 093	Sylvania	031, 023, 024, 027
Dimensia	045, 093	Pentax	058, 005, 045, 093	Symphonic	027, 081
Emerson	043, 026, 077, 061, 025, 042, 020, 076	Philco	031, 024, 027, 023, 026, 020, 043	Tashiro	064
Fisher	063, 066, 067, 065, 071, 091	Philips	031, 023, 024, 086	Tatung	003, 004, 005
Funai	027, 026, 020, 000	Pioneer	023	Teac	003, 004, 027, 005
G.E.	033, 045, 024	Proscan	045, 058, 023, 024, 031, 046, 059, 060, 093, 033, 087	Technics	021, 022, 023, 024
Go Video	037, 051, 049, 050, 089	Quasar	021, 022, 023, 024	Teknika	024, 027, 070
Goldstar	064	Radio Shack	033, 024, 063, 036, 067, 040, 027	Thomson	033, 096
Gradiente	083, 084, 081, 000, 001	RCA	033, 045, 058, 023, 024, 031, 046, 059, 060, 083, 084, 085, 087, 093, 096	Toshiba	059, 046, 079
Hitachi	023, 045, 058, 093, 027, 081	Realistic	024, 063, 036, 067, 040, 027	Vector Research	005
Instant Replay	024, 023			Wards	035, 036, 067, 044, 064
Jensen	003			Yamaha	063, 003, 004, 005
JVC	003, 004, 005, 000, 001, 002, 006, 007			Zenith	044, 082, 064, 094
Kenwood	003, 004, 064, 005				
LG	064				
LXI	027, 064, 058, 065, 066, 063, 067				
Magnavox	031, 023, 024, 086				

Remote Programming

DVD Codes

The remote control is programmed with DVD codes for power on/off, play, stop, fast-forward, rewind, previous/next chapter, tray open/close, and still/pause operation.

- 1) Find the DVD player brand from the list of codes shown below.
 - 2) Slide the first 2-way selector switch to "TV" and the other 2-way selector switch to "DVD".
 - 3) Press and hold down the DISPLAY button, then enter the first code number listed with the 10 key pad.
 - 4) Release the DISPLAY button, and confirm the operation of the DVD player.
- If your DVD player does not respond to the first code, try the others listed. If it does not respond to any of the codes, try the search codes function on page 31.
 - After you program your remote, some DVD buttons may not work properly. If so, use the DVD player's remote.

DVD Player	CODES	DVD Player	CODES	DVD Player	CODES
Aiwa	043	Mintek	057	Sharp	028
Apex	040, 054, 055	Mitsubishi	025	Sylvania	038
Bose	058	Next Base	056	SMC	048
Denon	020, 037	Onkyo	041, 052	Sony	024, 045, 046, 047
Funai	038	Oritron	044	Technics	020
Go-Video	032	Panasonic	020	Thomson	021
Harman Kardon	053	Philips	023, 036	Toshiba	023
Hitachi	031	Pioneer	022	Venturer	051
JVC	000	Polk Audio	036	Vialta	050
Kenwood	035, 020	Raite	033	Wave	042
KLH	051	RCA	021, 026	Yamaha	020, 049
Konka	039	Sampo	034	Zenith	027, 032
Koss	050	Samsung	030		

Remote Programming

Search Codes

Cable/Satellite Search Codes Function

- 1) Slide the first 2-Way Mode Selector switch to CATV.
- 2) Press and hold down the POWER button, then press the RETURN+/TV button for more than three seconds.
- 3) Release the RETURN+/TV button, then release the POWER button.
- 4) Press the POWER button on the remote, and see if the cable or satellite box responds.
- 5) If there was a response, press RETURN+/TV. The codes are now set. If there was no response, repeat Step 4. If you repeat Step 4 a total of 80 times without a response, use the remote control that came with your equipment.
- 6) Press RETURN+/TV to exit.



VCR/DVD Search Codes Function

- 1) Slide the first 2-way selector switch to "TV" and the other 2-way selector switch to "VCR" or "DVD".
- 2) Press and hold down the VCR or DVD POWER button, then press the RETURN+/TV button for more than three seconds.
- 3) Release the RETURN+/TV button, then release the VCR or DVD POWER button.
- 4) Press the VCR or DVD POWER button, and see if the VCR or DVD responds.
- 5) If there was a response, press RETURN+/TV. The codes are now set. If there was no response, repeat Step 4. If you repeat Step 4 a total of 80 times for the VCR (40 times for the DVD player), and there is no response, use the remote control that came with your equipment.
- 6) Press RETURN+/TV to exit.

Onscreen Menus

Using the Guide

Certain symbols are used throughout this guide to help you learn about the features of your new television. The ones you will see most frequently are:

- ▲▼ Up and Down arrows mean press the CH+ or CH- buttons. Pressing the CH+ or CH- buttons let you:
 - Move vertically in a main menu screen
 - Move through a submenu screen
 - Move to the next letter, number, or other choice in a submenu
 - Back up to correct an error
 - Scan through TV channels (when not in a menu screen)
- ◀▶ Left and right arrows mean press the VOLUME+ or VOLUME- buttons to move left or right to:
 - Select a highlighted menu item
 - Select an item in a submenu
 - Select numbers in certain menu options
 - Turn the volume up or down (when not in a menu screen)
-  The “press button” icon means you should press the button named on your remote control. (Button names appear in SMALL CAPITAL LETTERS.)
-  The “helping arrow” icon points to the highlighted or selected item in a menu.

To bring up the onscreen menu, press the MENU button on the remote control. The item that appears in green is the one currently selected. If you use the Menu button on the TV’s front panel instead of the remote, an additional menu screen showing INPUT and ASPECT will appear between INITIAL SETUP and PICTURE ADJUST. The “interactive plug-in menu” will appear the first time the TV is plugged in.

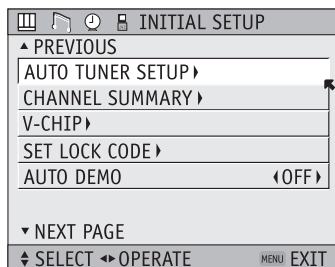

Note:

- Menus shown in this book are illustrations, not exact replications of the television’s onscreen displays.

Onscreen Menus

The Onscreen Menu System

Your television comes with JVC's onscreen menu system. The onscreen menus let you make adjustments to your television's operation simply and quickly. Examples of the onscreen menus are shown on the next page. Detailed explanations on using each menu follow later in this guide. For information about the interactive plug-in Menu, see pages 25 - 27.

The Onscreen Menu System

To open the onscreen menu system, press the MENU button on the remote control. You navigate within the onscreen menus by using the four directional arrow buttons on the remote control. (These buttons are also the CH +/- and VOL +/- buttons. Channel and volume functions will not operate when the onscreen menu is active).

The selected feature and option on a menu screen are highlighted in a different color.

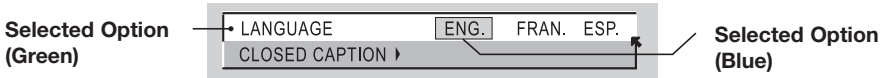

To move to a different feature use the ▲ ▼ arrows to move up or down the list. When you press the up arrow at the top of the list or the down arrow at the bottom, the next menu screen will appear. Use the arrows ◀ ▶ to select an option from the highlighted feature. Pressing MENU on the remote control will close the onscreen menu system and return you to normal television viewing.

Each menu and its features will be discussed in the following pages of this guide.

Notes:

- If you do not press any buttons for about a minute, the onscreen menu will automatically shut off.
- Button names in this guide are shown in SMALL CAPITAL LETTERS.
- Menus may appear in different sizes onscreen depending on the aspect ratio selected.
- Some menu items may not appear in menu screens when certain aspect ratios or inputs are selected.

Onscreen Menus



Press the MENU button

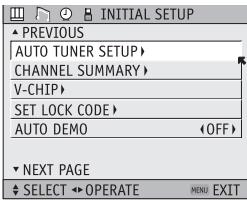

INITIAL SETUP 04

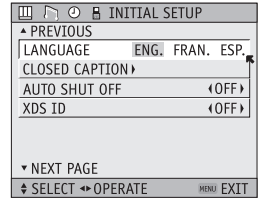
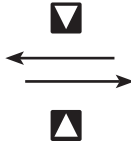

INITIAL SETUP 03

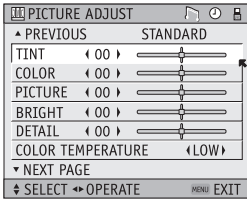

PICTURE ADJUST 01

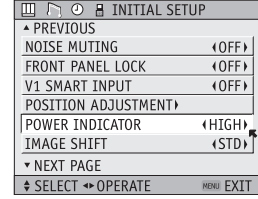

INITIAL SETUP 02

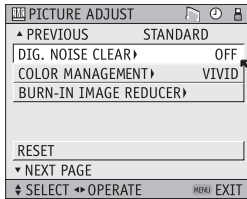
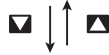

PICTURE ADJUST 02

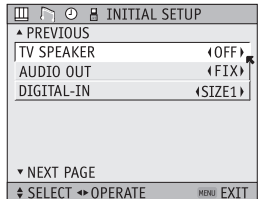

INITIAL SETUP 01

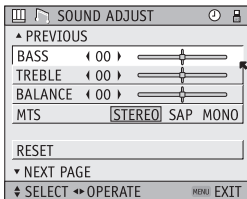

SOUND ADJUST

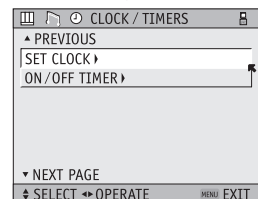
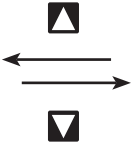

CLOCK/TIMERS

Notes:

- The DIGITAL-IN menu can only be displayed when a 480p picture signal is input to the digital-in terminal and the picture is being displayed on the screen.
- When the Menu button on the TV front panel is pressed, the FRONT PANEL CONTROL menu between INITIAL SETUP 03 and PICTURE ADJUST 01 will appear.

Initial Setup

Auto Tuner Setup

The auto tuner setup function is described on page 27 as the interactive plug-in menu. If you need to run the auto tuner setup again, follow the steps below.



Press the MENU button



To AUTO TUNER SETUP



To operate



To choose CABLE or AIR



Press the Ok button to start

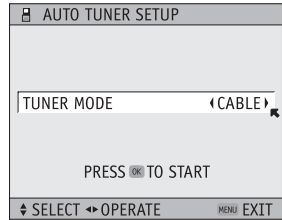

Programming will take approximately 1 to 2 minutes. The auto tuner is finished when the message **PROGRAMMING OVER!** appears onscreen.



Press the Menu button when finished

Channel Summary

Channel summary allows you to customize the line-up of channels received by your TV. You can add or delete channels from the line-up or prevent any unauthorized viewers from watching any or all 181 channels.



Press the MENU button



To CHANNEL SUMMARY



To operate

The Channel summary screen will now be displayed with the channels set to scan marked with an “✓”. You can delete channels from the scan by removing the “✓”. If any channels were missed during auto tuner setup and you wish to add them, you may by placing an “✓” next to the channel number.



To the SCAN column



Press the Ok button to include or delete from scan



Press the MENU button when finished

CHNO.	SCAN	LOCK	CHNO.	SCAN	LOCK
01		🔒	06	✓	🔒
02	✓		07	✓	
03			08		
04	✓		09	✓	
05	✓		10		

You can block access to a channel by activating the channel lock.



Press the MENU button



To CHANNEL SUMMARY



To operate



To the Lock Column (🔒)



Press the ZERO button to lock or unlock that channel



Press the MENU button when finished

Initial Setup

Channel Guard Message

When a viewer attempts to watch a guarded channel, the following message appears:

To watch a channel that you have locked, enter the Lock Code using the 10 key pad. If the wrong code is entered, the message "INVALID LOCK CODE!" will flash on the screen.

The channel cannot be accessed until the correct code is entered.

Notes:

- Once a channel has been unlocked, it will remain unlocked until the television is turned off.
- See also "Set Lock Code", page 42.

THIS CHANNEL IS LOCKED BY
CHANNEL GUARD.
PLEASE ENTER LOCK CODE BY
10 KEY PAD TO UNLOCK IT.
NO. - - - -

V-Chip

Your TV is equipped with V-Chip technology which enables you to block channels or content that you feel to be inappropriate for children, based on US and Canada rating guidelines. V-Chip has no effect on video signals from a DVD discs, VCR tapes or Camcorder connection.

Note: Some programs, and movies are broadcast without a ratings signal. Even if you set up V-CHIP ratings limits, these programs will not be blocked. See page 37 for information on how to block unrated programs.

Note (for Canadian viewers): The V-Chip function is based on specifications designed for the United States and therefore may not work properly in Canada.

You can customize the V-Chip settings of your television to match your personal tastes. The V-Chip menu below is the starting point for your V-Chip settings.

You can use US V-Chip settings (for programming broadcast from the United States), Canadian V-Chip settings (for programming broadcast from Canada), and movie ratings. You may use any or all of the settings (US V-Chip, Canada V-Chip, Movie ratings). Descriptions for setting each of the three V-Chip formats appear in the next six pages along with descriptions of the rating categories.

To access the rating categories:



Press the MENU button



To V-CHIP



To operate (Lock icon  will appear)



Press ZERO to access the V-Chip menu



To turn V-Chip ON or OFF (V-Chip must be turned ON for rating settings to operate)



To move to SET US TV RATINGS, SET MOVIE RATINGS, or SET CANADIAN RATINGS (see following pages for descriptions of each item)

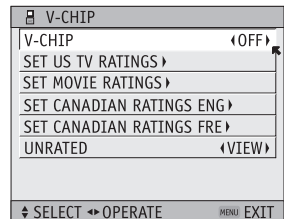

Initial Setup

Unrated Programs

Unrated programming refers to any programming which does not contain a rating signal. Programming on television stations which do not broadcast rating signals will be placed in the “Unrated Programming” category.

Examples of Unrated programs:

- Emergency Bulletins
- News
- Public Service Announcements
- Sports
- Some Commercials
- Locally Originated Programming
- Political Programs
- Religious Programs
- Weather

Note:

- TV programs or movies that do not have rating signals will be blocked if the unrated category is set to BLOCK.

Directions to Block Unrated Programs

You can block programs that are not rated.



Press the MENU button



To V-CHIP



To operate (The lock icon  appears)



Press ZERO to access V-Chip setup options



To UNRATED



To VIEW or BLOCK



Press MENU when done

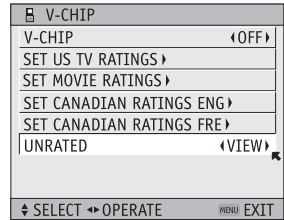

Initial Setup

US V-Chip Ratings

U.S. PARENTAL RATING SYSTEMS

Programs with the following ratings are appropriate for children.

TV Y is Appropriate for All Children

Programs are created for very young viewers and should be suitable for all ages, including children ages 2 - 6.

TV Y7 is for Older Children

Most parents would find such programs suitable for children 7 and above. These programs may contain some mild fantasy violence or comedic violence, which children should be able to discern from reality.

Programs with the following ratings are designed for the entire audience.

TV G stands for General Audience

Most parents would find these programs suitable for all age groups. They contain little or no violence, no strong language, and little or no sexual dialog or situations.

TV PG Parental Guidance Suggested

May contain some, but not much, strong language, limited violence, and some suggestive sexual dialog or situations. It is recommended that parents watch these programs first, or with their children.

TV 14 Parents Strongly Cautioned

Programs contain some material that may be unsuitable for children under the age of 14 including possible intense violence, sexual situations, strong coarse language, or intensely suggestive dialog. Parents are cautioned against unattended viewing by children under 14.

TV MA Mature Audiences Only

These programs are specifically for adults and may be unsuitable for anyone under 17 years of age. TV MA programs may have extensive V, S, L, or D.

Viewing Guidelines

In addition to the ratings categories explained above, information on specific kinds of content are also supplied with the V-Chip rating. These types of content may also be blocked. The content types are:

- **V/FV** is for VIOLENCE/FANTASY VIOLENCE
- **S** stands for SEXUAL CONTENT
- **L** stands for strong LANGUAGE
- **D** stands for suggestive DIALOG

Initial Setup

Setting US V-Chip Ratings



Press the MENU button



To V-CHIP



To operate (The lock icon  appears)



Press ZERO to access the V-Chip menu





To turn V-Chip ON or OFF

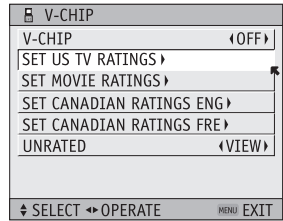

To move to SET US TV RATINGS



Directions to set US V-Chip Ratings

Line up the cursor in the column (TV PG, TV G, etc.) with the content row (V/FV, S, etc.) and press the  or  to move the cursor to the correct location. Press Ok to turn the locking feature on or off. An item is locked if the  icon appears instead of a “—”.

For example. To block viewing of all TV 14 shows, move the cursor to the top row of that column and add a lock icon. Once you've put a lock on the top row, everything in that column is automatically locked.



To the TV 14 Column



Press the Ok button to lock



Press the MENU button when finished

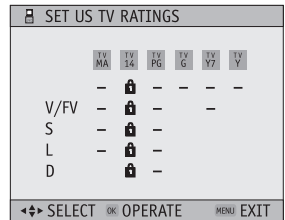

Note:

- If you want to change the setup, move the cursor to the top column and change the lock icon to “—” by pressing OK again. You may then select individual categories to block.

Initial Setup

Movies Ratings

NR – Not Rated

This is a film which has no rating. In many cases these films were imported from countries which do not use the MPAA ratings system. Other NR films may be from amateur producers who didn't intend to have their film widely released.

NR (Not Rated) Programming may contain all types of programming including children's programming, foreign programs, or adult material.

G – General Audience

In the opinion of the review board, these films contain nothing in the way of sexual content, violence, or language that would be unsuitable for audiences of any age.

PG – Parental Guidance

Parental Guidance means the movie may contain some contents such as mild violence, some brief nudity, and strong language. The contents are not deemed intense.

PG-13 – Parents Strongly Cautioned

Parents with children under 13 are cautioned that the content of movies with this rating may include more explicit sexual, language, and violence content than movies rated PG.

R – Restricted

These films contain material that is explicit in nature and is not recommended for unsupervised children under the age of 17.

NC-17 – No One Under 17

These movies contain content which most parents would feel is too adult for their children to view. Content can consist of strong language, nudity, violence, and suggestive or explicit subject matter.

X – No One under 18

Inappropriate material for anyone under 18.

Directions to set Movie (MPAA) Ratings



Press the MENU button



To V-CHIP



To operate (The lock icon  appears)



Press ZERO to access V-Chip setup options



To SET MOVIE RATINGS



To enter movies menu

For example:

To block viewing of X and NC-17 rated from shows:



To the X Column



Press the Ok button to lock



To the NC-17 Column



Press the Ok button to lock



Press the MENU button to finish

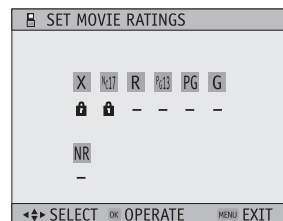

Canadian V-Chip Ratings

E – Exempt

Exempt programming includes: news, sports, documentaries and other information programming, talk shows, music videos, and variety programming.

C – Programming Intended for Children

Violence Guidelines: There will be no realistic scenes of violence. Depictions of aggressive behavior will be infrequent and limited to portrayals that are clearly imaginary, comedic or unrealistic in nature.

C8+ – Programming Intended for Children 8 and Over

Violence Guidelines: Any realistic depictions of violence will be infrequent, discreet, of low intensity and will show the consequences of the acts. There will be no offensive language, nudity or sexual content.

G – General Audience

Programming will contain little violence and will be sensitive to themes which could affect younger children.

PG – Parental Guidance

Programming intended for a general audience, but which may not be suitable for younger children. Parents may consider some content not appropriate for children aged 8-13.

14+ – 14 Years and Older

Parents are strongly cautioned to exercise discretion in permitting viewing by pre-teens and early teens. Programming may contain mature themes and scenes of intense violence.

18+ – Adult

Material intended for mature audiences only.

Directions to set Canadian V-Chip Ratings



Press the MENU button



To V-CHIP



To operate (The lock icon  appears)



Press ZERO to access V-Chip setup options



To SET CANADIAN RATINGS ENG (for English)



To enter ratings menu

For example:

To block viewing of programming rated 14+ and 18+:



To the 18+ Column



Press the Ok button to lock



To the 14+ Column



Press the Ok button to lock

Press the MENU button to finish

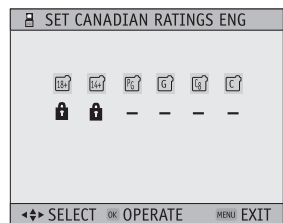

Note:

- For instructions on “SET CANADIAN RATINGS FRE (in French)”, please see page 41 in the French side of this user’s guide.

Initial Setup

Set Lock Code

Channel guard and V-Chip settings are protected by a four-digit lock code. Your TV comes pre-set with a lock code of "0000". You may change the code to any four-digit number you wish. To change the lock code, follow the steps below.



Press the MENU button



To SET LOCK CODE



To operate (The lock icon  appears)



Press ZERO to access the lock code

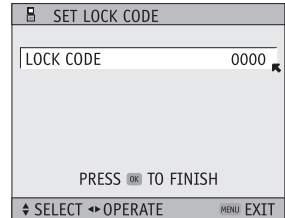

The first digit will be highlighted



To select the number



To move to the next digit

Continue to follow these directions for all four numbers



Press the OK button to finish (your lock code is now set)



Press the Menu button when finished

When a viewer attempts to watch a blocked channel, this message appears:

THIS PROGRAMMING EXCEEDS
YOUR RATING LIMITS.
PLEASE ENTER LOCK CODE BY
10 KEY PAD TO UNLOCK IT.
NO. - - - -

The channel will remain blocked until the correct lock code is entered (see above for information on setting your lock code).

Notes:

- After a power interruption you must reset the lock code.
- Write your lock code number down and keep it hidden from potential viewers.
- If you forget the lock code, a new code may be set using the steps listed above.

Initial Setup

Auto Demo

This function lets you preview the many different viewing modes of your TV. It will cycle through “index”, “split demo”, “freeze”, all of the different “aspect” ratios and all of the different “video status” modes.



Press the MENU button



To AUTO DEMO



To turn AUTO DEMO ON or OFF

Notes:

- Auto demo starts 2 seconds after it is set to ON.
- To stop auto demo, press the MENU button, and select auto demo by pressing the ▲▼ buttons, and turn it off by pressing the ◀▶ buttons. Press the MENU button to finish.

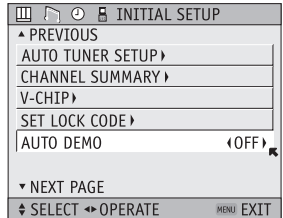

Power Indicator

Power indicator allows you to adjust the brightness of the power indicator.



Press the MENU button



To POWER INDICATOR



To adjust POWER INDICATOR LOW, HIGH or OFF

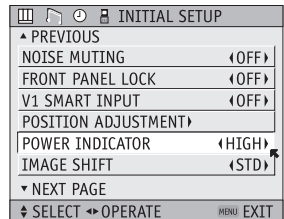

Position Adjustment

Position adjustment allows you to adjust the position of the picture on the screen vertically when the aspect is set to panorama, cinema, or full.



Press the MENU button



To POSITION ADJUSTMENT



To enter



To adjust the position



Press the MENU button to finish



Notes:

- To reset the adjustment to the center, press the Ok button.
- When the arrow disappears, while you are adjusting the position, the position is at its maximum limit.
- If you select regular size with aspect or Multi Screen, position adjustment option is not seen.
- When you change the screen size, perform the position adjustment again.
- Position adjustment allows you to adjust the screen position vertically and horizontally when the aspect is set HD panorama or cinema zoom for 1080i signal.

Initial Setup

Digital-In

The DIGITAL-IN option can only be displayed in the INITIAL SETUP menu when a 480p picture signal is being input to the DIGITAL-IN terminal.

This option adjusts the position when a 480p picture signal is being displayed on the screen.

There are two types of 480p picture signals: 640x480 and 720x480. If the displayed picture is slightly shifted, the position can be adjusted by selecting either SIZE1 or SIZE2.



Press the MENU button



To DIGITAL-IN



To enter



To select SIZE1 or SIZE2



Press the MENU button to finish

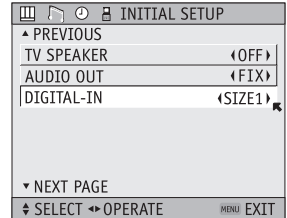

Note:

The DIGITAL-IN menu can only be displayed when a 480p picture signal is input to the Digital-In terminal and the picture is being displayed on the screen.

TV Speaker

If your TV is connected to a stereo system, you can turn off the TV speakers and listen to the audio through your stereo.



Press the MENU button



To TV SPEAKER



To turn the TV's speakers ON or OFF



Press the MENU button when finished

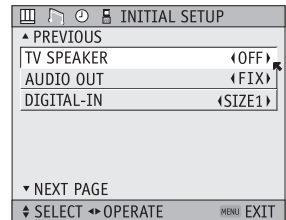

Notes:

- Before you turn the TV speaker setting from OFF to ON, **make sure that the TV volume level is low!** If the TV volume is set too high, the sound level will be extremely loud.
- After a power interruption, the TV speaker settings will return to "ON".

Initial Setup

Audio Out

If your television is connected to an external speaker source, audio out gives you the option of controlling the volume level with your TV's remote control.



Press the MENU button



To AUDIO OUT



To VARI or FIX



Press the MENU button when finished

VARI: Lets you adjust the volume of the external speakers using the VOLUME +/- buttons on your TV's remote control.

FIX: The volume of the external speakers is adjusted using the audio device's remote control.

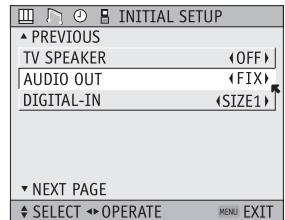

Image Shift

The picture displayed on the screen is shifted up, down and to the left and right at regular intervals. In order to prevent burn-in, set this function to FAST or STANDARD.



Press the MENU button



To IMAGE SHIFT



To select the mode "STD (STANDARD)", "FAST" or "OFF"



Press the MENU button when finished

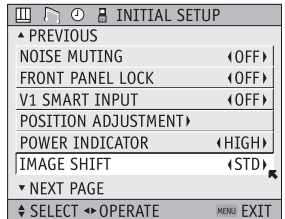

OFF: IMAGE SHIFT is turned off.

STD: The picture is shifted every 30 minutes.

FAST: The picture is shifted every 10 minutes.

Language

The language function is described on page 25 as the interactive plug-in menu. If you need to choose the language again, follow the steps below.



Press the Menu button



To LANGUAGE



To choose a language: ENG. (English), FRAN. (French) or ESP. (Spanish)



Press the MENU button when finished

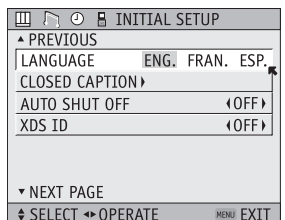

Initial Setup

Closed Caption

Many broadcasts now include an onscreen display of dialog called closed captions. Some broadcasts may also include displays of additional information in text form. Your television can access and display this information using the closed caption feature. To activate the closed caption feature, follow the steps below.



Press the MENU button



To CLOSED CAPTION



To operate



To select CAPTION or TEXT



To select a caption (CC1 to CC4) or text channel (T1 to T4)



Press the OK button to save



Press the MENU button when finished

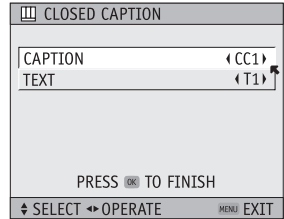

Notes:

- Closed caption subtitles are usually found on closed caption channel CC1. Some programs may include additional text information which is usually found on text channel T1. The other channels are available for future use.
- Closed captioning may not work correctly if the signal being received is weak or if you are playing a video tape.
- Most broadcasts containing closed captioning will display a notice at the start of the program.
- To select the mode, press the C.C. button. See page 61.

Noise Muting

This feature inserts a blank gray screen over channels which are not broadcasting or are too weak to be received clearly.



Press the MENU button



To NOISE MUTING



To turn noise muting ON or OFF



Press the MENU button when finished

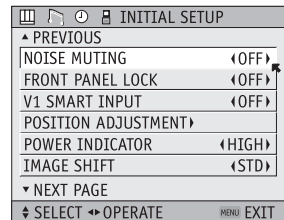

Note:

- Noise muting will not work during auto tuner setup or when you operate channel summary.

Front Panel Lock

This allows you to lock the keys on the front of the TV, so that a child may not accidentally change your viewing preferences.



Press the MENU button



To FRONT PANEL LOCK



To turn ON or OFF



Press the MENU button when finished

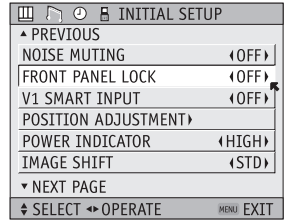

You can turn off this feature in the following ways:

- Unplug the power cord, and plug it back in. Do this if your batteries die, or you lose your remote control.
- Use the remote control.
- Press the MENU button on the front of the TV for more than 3 seconds. In this case, the OSD for FRONT PANEL LOCK will appear.

Note:

- To turn ON/OFF the TV, press the power button for more than 3 seconds. This feature will remain ON.

V1 Smart Input

This feature is used if you have connected an AV Receiver to your television. By turning this feature on, your television can automatically detect the signal source from your components that are connected to your AV Receiver. Refer to page 24 for how to connect an AV receiver to your television.



Press the MENU button



To V1 SMART INPUT



To turn ON or OFF



Press the MENU button when finished

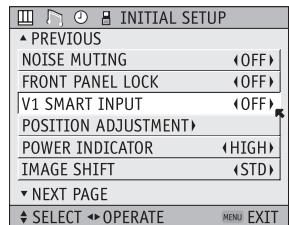

Notes:

- If you do not have an AV Receiver connected to your television, turn this feature OFF. By doing so, you can take advantage of using AV CompuLink components with your television.
- Some AV Receivers may not work with this function.

Initial Setup

Auto Shut Off

This function automatically shuts off your TV when there is no signal from the channel the TV is on.



Press the MENU button



To AUTO SHUT OFF



To turn ON or OFF



Press the MENU button when finished

- If the channel that you have on does not receive a signal for more than one minute, the blinking text “NOT RECEIVING A SIGNAL” appears on the screen, and starts the countdown. If no signal is being received within 10 minutes, the TV shuts itself off.

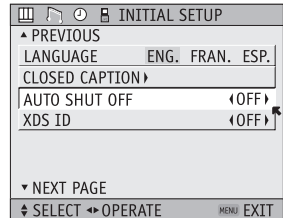

XDS ID

XDS ID Display provides a channel's call letters, the network's name, and even a program name. The XDS ID information is provided by the broadcaster.



Press the MENU button



To XDS ID



To turn ON or OFF



Press the MENU button when finished

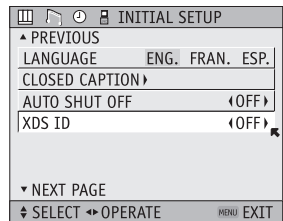

Picture Adjust

Picture Settings

These settings allow you to change and adjust the way the picture appears on your television.

TINT

Tint allows you to adjust the levels of red and green in your TV picture.

COLOR

The color function lets you make all the colors in the TV picture appear either more vivid or subtle.

PICTURE

Picture allows you to adjust the levels of black and white on the TV screen, giving you a darker or brighter picture overall.

BRIGHT

You can adjust the overall brightness of the TV picture with the Bright control.

DETAIL

The Detail feature adjusts the level of fine detail displayed in the picture.

Adjust the Picture Settings



Press the MENU button



To TINT, COLOR, PICTURE, BRIGHT or
DETAIL



To enter

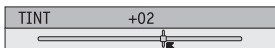

To adjust the setting



To move to the next setting



Press the MENU button when finished

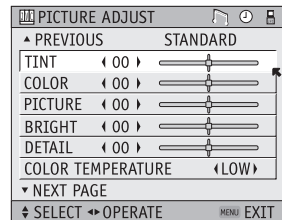

Color Temperature

You can decide how strong or dull the colors appear on the TV screen.



Press the MENU button



To COLOR TEMPERATURE



To enter



To set LOW or HIGH



Press the MENU button when finished

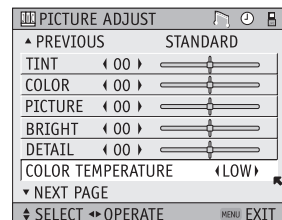

Picture Adjust

Digital Noise Clear

With digital noise clear, this helps take our static or noise from a channel that may not be coming in clearly.



Press the MENU button



To DIG. NOISE CLEAR



To enter



To select the mode "LOW", "HIGH" or "OFF"



Press the MENU button when finished

DIG. NOISE CLEAR	
	OFF
	LOW
	HIGH

Color Management

This TV supports the COLOR MANAGEMENT function to ensure dull colors are compensated to produce natural hues.



Press the MENU button



To COLOR MANAGEMENT



To enter



To select the mode "VIVID", "STD" or "OFF"



Press the MENU button when finished

COLOR MANAGEMENT	
	VIVID
	STD
	OFF

Burn-in Image Reducer

When burn-in is minimal, burn-in and residual images may be softened with the BURN-IN IMAGE REDUCER function.



Press the MENU button



To BURN-IN IMAGE REDUCER



To enter

REDUCING BURN-IN. PLEASE WAIT

Burn-in will be reduced by displaying snow on the screen for approximately 55 seconds, and white for approximately 5 seconds in sequence. Leave the television in this state for some time (more than a few hours).



Push the MENU button to bring back to the normal screen.

Reset

Reset resets all picture adjustments (tint, color, picture, bright, detail, color temperature, dig. noise clear and color management) at once to the default settings.



Press the MENU button



To RESET



To enter

The onscreen menu disappears for a moment, and then the settings are reset to the default setting for all the picture adjustments.



Press the MENU button when finished

PICTURE ADJUST	
▲ PREVIOUS	STANDARD
DIG. NOISE CLEAR▶	OFF
COLOR MANAGEMENT▶	VIVID
BURN-IN IMAGE REDUCER▶	
RESET	
▼ NEXT PAGE	
◆ SELECT ↔ OPERATE	MENU EXIT

Sound Adjust

Sound Settings

These settings allow you to change and adjust the way the picture appears on your television.

BASS – You can increase or decrease the level of low-frequency sound in the TV's audio with the bass adjustment.

TREBLE – Use treble to adjust the level of high-frequency sound in your TV's audio.

BALANCE – Adjust the level of sound between the TV's left and right speakers with the balance setting.

Adjust the Sound Settings



Press the MENU button



To BASS, TREBLE or BALANCE



To adjust the setting



To move to the next setting



Press the MENU button when finished

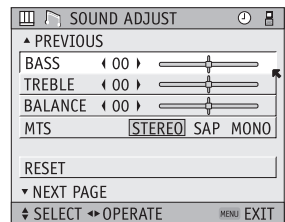

Notes:

- You can reset the sound adjustments (BASS, TREBLE and BALANCE) you set at once as the default setting when you select reset. See page 50.
- You can adjust BALANCE only when A.H.S. is off. See page 57.

MTS (Multi-Channel Television Sound)

MTS technology allows several audio signals to be broadcast at once, giving you a choice in what you wish to hear with a TV program. In addition to mono or stereo sound, an MTS broadcast may also include a second audio program (SAP).



Press the MENU button



To MTS



Select the mode

(The ON AIR arrow tells you if a broadcast is in stereo and/or contains an SAP).



Press the MENU button when finished

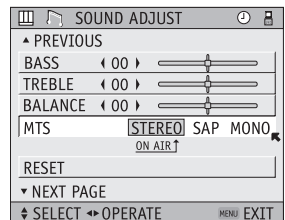

Notes:

- Keep the TV in stereo mode to get the best sound quality. The sound will work in stereo mode even if a certain broadcast is in mono sound only.
- Choose the mono setting to reduce excessive noise on a certain channel or broadcast.
- Selecting SAP will allow you to hear an alternative soundtrack, if one is available.
- MTS unavailable if your television's input source is in input 1, 2, 3 or 4 mode, as described on page 56.

Clock/Timers

Set Clock

The set clock function is described on page 26 as the interactive plug-in menu. You can choose to set the clock automatically, or manually. If you need to set the clock again, follow the steps below.



Press the MENU button



To SET CLOCK



To operate

When you set the clock automatically, choose **AUTO** by pressing the ◀ or ▶ arrows.



To TIME ZONE



To select your time zone



To D.S.T. (daylight savings time)



To turn D.S.T. ON or OFF



Press OK to finish



Press the MENU button when finished

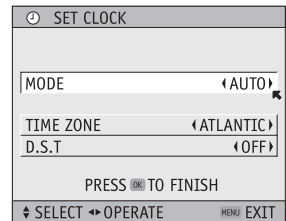

When you set the clock manually, choose **MANUAL** by pressing the ◀ or ▶ arrows.



To move to the hour



To set the hour



To move to minutes



To set the minutes



Press OK to start clock

THANK YOU !!



Press the MENU button when finished

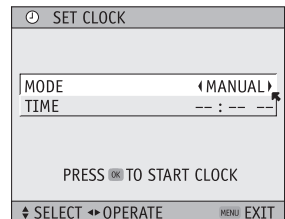

On/Off Timer

The on/off timer lets you program your television to turn itself on or off. You can use it as an alarm to wake up, to help you remember important programs, or as a decoy when you're not home.



Press the MENU button



To ON/OFF TIMER



To operate (begins with ON TIME)



To set the hour (AM/PM) you want the TV to turn on



To move to minutes



To set the minutes



To accept ON TIME and move to OFF TIME (the time the TV will turn off). Set the OFF TIME the same way as ON TIME



To accept OFF TIME and move to CHANNEL



To select channel



To ON VOLUME



To set the volume level



To move to MODE



Choose ONCE or EVERYDAY



To ON/OFF TIMER



Choose YES to accept the timer setting, choose NO if you don't wish to accept



Press the OK button to finish



Press the MENU button to exit the menu

ON/OFF TIMER	
ON TIME	7:00 PM
OFF TIME	10:00 PM
CHANNEL	03
ON VOLUME	CURRENT
MODE	⟨EVERYDAY⟩
ON/OFF TIMER	⟨NO⟩
PRESS OK TO FINISH	
SELECT → OPERATE	MENU EXIT

Notes:

- The on/off time cannot be set to locked or guarded channels.
- In order for the on/off timer to work, the clock must be set.
- After a power interruption, the timer settings must be reset.

Button Functions

Multi Screen Function

Your television has two kinds of screen: SPLIT (2 channels) and INDEX (12 channels).

Note: After you press any multiscreen button, if you press the menu button, only the picture adjust screen will appear.

Split

Activate the split-screen option by pressing SPLIT on the remote control.

A channel and input will now appear onscreen. The channel (or input) you were watching before pressing SPLIT will appear on the left, the input will appear on the right. The sound will continue to come from the main screen channel (or input). To turn split-screen off and return to normal television viewing, press SPLIT again or press the BACK button.

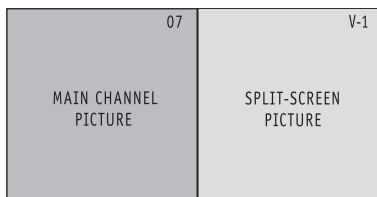

Notes:

- You can enter the SPLIT mode when the screen is in NORMAL or INDEX mode.
- Split-screen functions will not work with locked channels or channels blocked by V-Chip ratings limits. A grey screen will display instead.
- With split screen, the picture from the component terminal and HDCP terminal will not be displayed.
- The aspect of MAIN CHANNEL PICTURE becomes 16:9 when you input the picture of 480p, 720p and 1080i from the component terminal and HDCP terminal.
- After you press the Select button, and select SPLIT SCREEN when you press the OK button, select normal screen. If you don't operate, the MAIN CHANNEL SCREEN will be automatically selected about 8 seconds later.
- Main channel picture and split-screen will not display the same RF channel and same input.

Button Functions

Index

This allows you to quickly look at up to 12 channels at a time so that you can decide which one to watch.

1	2	3	4
5	6	7	8
9	10	11	12

Notes:

- Only RF input signal will be displayed.
- You can watch the channel added in channel summary. See page 35.

Freeze

Pressing the FREEZE button causes the screen to change to the split-screen display with the still picture displayed on the right. In order to return to the normal display, press the FREEZE button once again.

Note: When the screen is in freeze mode, if you do not operate it within 15 minutes, this function will cancel out.

Swap

You can exchange the channel (or input) displayed in the split screen window for the main screen image by pressing the SWAP button.

Note: It will only work in SPLIT mode.

Select

With SELECT, you can select the picture (channel) while viewing SPLIT screen. When you press SELECT button, the channel number on the top will be highlighted. Each press of SELECT will shift the channel.

Button Functions

Power

Turns the TV on or off.



Press the **POWER** button

Number Buttons - 10Key Pad

Use the number buttons on the remote control to move directly to a specific channel. For example, to move to channel 7:



0 (Zero)



7 (Seven)

100+ Button

Use the 100+ button to directly access channels above channel 99. For example, to move to channel 124, press 100+, 2 (Two), 4 (Four).

Input

Selects the signal input source for the television: Input-1, 2, 3 or 4 for video devices like VCR's DVD players, or camcorders.



INPUT 1, 2, 3, 4

Note:

- When you return to TV mode, press the **RETURN +/TV** button or direct 10 key pad.

Digital-In

Use this button to directly select the digital-in input.



Press the **DIGITAL-IN** button

- Digital-In will display only when the 480p picture signal in Digital-In is displayed.

Button Functions

Return +/TV

The return+/TV button has three functions:

Return - Returns to the channel viewed just before the channel currently onscreen.

Return+ - Lets you program a specific channel to return to while scanning through the channels using the CH+ and CH- buttons.

TV - Returns to the TV mode.



RETURN+/TV and hold for three seconds

RETURN CHANNEL
PROGRAMMED !

The channel currently active has been programmed as your return+ channel.

Now scan through the channels using the CHANNEL+/- buttons.



RETURN+/TV

You will return to your programmed channel.

- To cancel your return+ channel, press and hold the RETURN+ button for three seconds. The message "RETURN CHANNEL CANCELLED!" will appear.
- Return+ works only with the Channel+/- buttons. Pressing any number key will cancel return+.

Sound

By pressing the sound button, you can change the A.H.S. (Advanced Hyper Surround) mode, BBE and A.H.B. (Active Hyper Bass) mode.

A.H.S. - Adds a more spacious surround sound. Music gives basic effect and movie for more effect.

BBE - BBE high definition audio adds natural, clear and extraordinary sound quality to any program.

A.H.B. - You can reinforce the bass sound to maintain rich, full bass at low volumes, and enjoy a clear sound with boosted bass.



Press the SOUND button



To select A.H.S., BBE or A.H.B.



To choose the setting



Press the MENU when finished

SOUND EFFECT	
A.H.S.	MOVIE MUSIC OFF
BBE	ON OFF
A.H.B.	ON OFF
↓ SELECT → OPERATE MENU EXIT	

Note: BBE is a registered trademark of BBE Sound, Inc. For U.S., licensed from BBE Sound, Inc. under USP 4638258, 4482866 and 5510572. For Canada, licensed from BBE Sound, Inc. BBE is a registered trademark of BBE Sound, Inc.

Button Functions

Muting

The MUTING button instantly turns the volume down completely when you press it. Press MUTING and the volume level will instantly go to zero. To restore the volume to its previous level, press MUTING again.

Video Status

The video status button gives you a choice of four TV picture display settings, including a display of your own preferences.

Standard - Resets the picture display to the standard settings.

Dynamic - Gives a vivid picture with better contrast when viewing in a brightly lit room.

Theater - Gives a rich, film-like look to video when viewing in a dimly lit room.

Game - Used for when you are playing video games connected to your TV.

VIDEO STATUS
STANDARD
DYNAMIC
THEATER
GAME



Press the VIDEO STATUS button

By every press of the VIDEO STATUS button, you change the mode.

Notes:

- You can also change the mode by pressing the ▲▼ buttons.
- The VIDEO STATUS function is initially set to DYNAMIC. Unless the TV is being watched in an extremely bright room, it is recommended to change the VIDEO STATUS setting to standard, theater or game. Doing so will reduce the chance of PDP burn-in and extend the life of the PDP.

Natural Cinema

Natural cinema corrects the problem of blurred edges which may occur when viewing a program originally shot on film (such as motion pictures) or animation. If you notice blurring at the edges of these programs, press NATURAL CINEMA and set it to AUTO. Natural Cinema helps correct conversion errors that occur when film, which is shot at 24 frames-per-second, is broadcast at the television rate of 30 frames-per-second.



Press the NATURAL CINEMA button

Note: The natural cinema mode is automatically set to "AUTO" in the following cases:

NATURAL CINEMA
AUTO
ON
OFF

- Turning on or off
- Changing the channel or input mode
- Using multi-screen functions

TheaterPro D6500K

The TheaterPro D6500K color temperature technology function makes sure that the video you watch is set to the standard color temperature, so that what you see is as true to what the film to video editors intended it to be.



Press the THEATERPRO button

Button Functions

Sleep Timer

The Sleep Timer can turn the TV off for you after you fall asleep. Program it to work in intervals of 15 minutes, for a total time of up to 180 minutes.



Press the SLEEP TIMER button

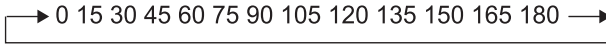

Sleep Timer Message

20 seconds before the automatic shutoff, this message will appear:

GOOD NIGHT!!
PUSH SLEEP TIMER BUTTON
TO EXTEND.

You then have 20 seconds to press the SLEEP TIMER button to delay the shut off for another 15 minutes.

Display

The display screen shows the current status of timers, inputs, and XDS ID.



Press the DISPLAY button

The screen to the right shows the following information:

- The current channel or AV input (Channel 05)
- The current time (12:20 pm)
- Sleep timer status/minutes remaining (The Sleep Timer is off)
- On/off timer status (Set to turn on everyday at 7:00 PM, off at 10:00 PM)
- Each Press of the DISPLAY button changes the display mode:

05 KLVX PBS	
SESAME STREET	
NOW	12:20 PM
SLEEP TIMER	OFF
ON/OFF TIMER	EVERYDAY
ON TIME	7:00 PM
OFF TIME	10:00 PM

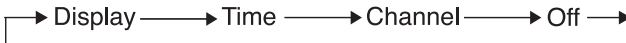

Display - Full screen shown above

Time - Shows the current time only

Channel - Shows the current channel

Off - Turns display off

Notes:

- You may also turn off the display at any step by pressing MENU.
- If the clock, sleep timer or on/off timer are not set, the display screen will show: "CLOCK NOT SET", "SLEEP TIMER OFF", and "ON/OFF TIMER OFF" respectively.

Button Functions

Aspect

This feature will help you adjust the picture you are watching to give you the best possible picture quality.

Aspect Ratios

PANORAMA - With this ratio a normal 4:3 aspect picture is stretched to fit the dimensions of the 16:9 aspect screen.

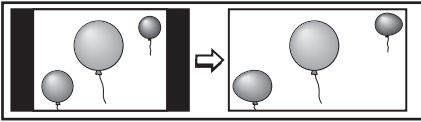

CINEMA - This ratio “zooms in” on the center part of a 4:3 aspect picture, blowing it up to fill the 16:9 screen.

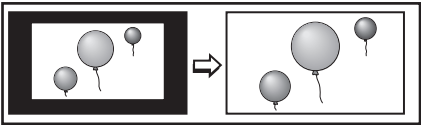

FULL - This is the ratio to use when watching 16:9 High-Definition broadcasts.

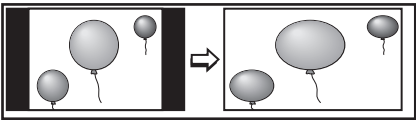

HD PANORAMA - This ratio stretches the High-Definition 16:9 aspect image to eliminate the black side bars.

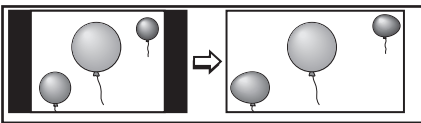

REGULAR - The regular ratio is used when you want to watch a 4:3 broadcast or recorded program without modifying the original picture to fit the dimensions of your 16:9 screen. The 4:3 picture will fill the screen from top to bottom, while black bars will appear to fill up the remaining space along the picture's sides. The 4:3 picture will be centered within the boundaries of the 16:9 screen.

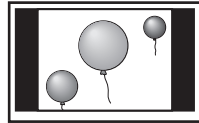

CINEMA ZOOM - This ratio stretches the High-Definition 16:9 aspect image to eliminate the black surrounding bars.

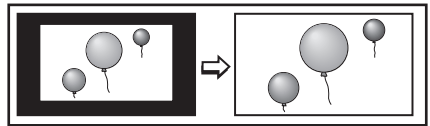

Button Functions

Aspect Ratios (Continued)



Press the ASPECT button

- By pressing the ASPECT button, you can change the size.

When you change the aspect ratios, it is different from their broadcast or recorded program.

NTSC, 480i, 480p,
HDCP 480p

ASPECT
PANORAMA
CINEMA
FULL
REGULAR

HD, HDCP 1080i

ASPECT
HD PANORAMA
CINEMA ZOOM
FULL

720P, HDCP 720p

ASPECT
FULL

Notes:

- You can also choose the size by pressing the ▲▼ buttons.
- When you change the aspect ratio or signal, reset the picture position to center.

C.C. (Closed Caption)

Use the C.C. (Closed Caption) button to select the mode of closed caption.



Press the C.C. button

CLOSED CAPTION
OFF
CAPTION
TEXT

- See page 46 when you set the caption/text mode.

Menu

The MENU button allows you to access JVC's onscreen menu system. Press MENU to activate the onscreen menu system.

- See individual topics like "Sound Adjust" for specific information on using menus.

OK

This button confirms your selection when you are in one of the onscreen menus.

Back

This button allows you to go back in the menu to change a selection or correct a mistake.

Button Functions

TV/CATV Slide Switch

Use either the television's own tuner or a cable box to select channels. Set this switch to **TV** to operate the television's built-in tuner. Move the switch to **CATV** to operate a cable box.

Note:

- See page 28 for information on programming your remote for cable box operation.

VCR/DVD Slide Switch

You can control a VCR or DVD player with the buttons on the lower part of the remote control. Move the slide switch to **VCR** or **DVD** to operate.

Notes:

- The remote is preset with the code 000 to control JVC-brand VCR's. For any other manufacturer's brand VCR, please see the code chart and instructions on page 29.
- The remote is preset with the code 000 to control JVC-brand DVD players. For any other manufacturer's brand DVD player, please see the code chart and instructions on page 30.

VCR Buttons

You can use this remote control to operate the basic functions of your VCR. These functions include: play, record, rewind, fast-forward, stop, pause, channel scan, TV/VCR, power on, and power off.

Move the selector switch to **VCR** to operate.

- The remote is preset with the code 000 to control JVC-brand VCR's. For any other manufacturer's brand VCR, please see the code chart and instructions on page 29.

DVD Buttons

You can also use this remote control to operate the basic functions of your DVD player. These functions include: play, rewind, fast-forward, stop, still/pause, previous/next, tray open/close, power on, and power off.

Move the selector switch to **DVD** to operate.

- The remote is preset with the code 000 to control JVC-brand DVD players. For any other manufacturer's brand DVD player, please see the code chart and instructions on page 30.

Light

Your remote control includes illuminated buttons for key features like channel +/- and Volume +/- . Press the light button to turn the illumination on for 4 seconds.

Troubleshooting

Refer to the table below to check the condition. If you think that there is a problem, contact the JVC Service Center where you purchased the television.

PROBLEMS	CHECK
There is no power	<ul style="list-style-type: none"> - Check for a blown fuse or circuit breaker or a power outage. - Check that the plugs on the power cords from the TV and receiver are connected to wall outlets.
The power lamps do not light even though the TV is on	Check that POWER INDICATOR in the MENU is not set to OFF.
There is no picture or sound	<ul style="list-style-type: none"> - The antenna could be disconnected. - The input mode could be set improperly. See page 56. - The tuner (AUTO TUNER SETUP) could be set improperly. See page 35. - The TV station may be having difficulties. Check to see if other stations are working.
Remote control is not operating properly or at all	<ul style="list-style-type: none"> - Check to see that the batteries are still working and properly installed. - Make sure the remote has a clear sight path to the TV. - Check that the TV/CATV switch is in the proper position. - You may be too far from the TV. You must be within 23 feet (7 meters). - Use the remote control while pointing it at the screen.
You cannot select a certain channel	<ul style="list-style-type: none"> - Make sure the channels have been programmed. See "Channel Summary" on page 35. - Check to see if the channel is locked. See "Channel Summary - Lock" page 36.
The power turns off by itself	<ul style="list-style-type: none"> - Make sure the set did not become unplugged. - Perhaps the ON/OFF TIMER is set. See page 53. - Check to see if the Sleep Timer was set. See page 59.
It does not operate correctly	This television is operated by a microprocessor. It is possible that external noise or interference is causing the problem. If the television does not function correctly, remove the power plugs of the TV and Receiver from the wall outlets and wait a while before inserting them into the wall outlets again and operating the television.
The clock is wrong	The power was interrupted and the clock was not reset. See page 52.
The color quality is poor	<ul style="list-style-type: none"> - Tint and Color may be improperly adjusted. See page 49. - The VIDEO STATUS mode may be turned to the wrong setting. See page 58.
There are line across the picture	There could be interference from another electrical appliance, such as a computer, another TV or VCR. Move any such appliances further away from the TV.
The picture is spotted	There could be interference from a high-wattage appliance, like a hair dryer or vacuum, operating nearby. Move the antenna away from the appliance or change to a coaxial cable connection which is less prone to interference.

Troubleshooting

PROBLEMS	CHECK
There are double pictures (ghosts)	A building or passing airplane can reflect the original signal and produce a second, slightly delayed one. Adjust your antenna position.
Picture is snowy (image noise)	<ul style="list-style-type: none">• Your antenna may be damaged, disconnected or turned.• Check the antenna connection, page 19 in Quick setup. If the antenna is damaged, replace it.
Screen is 80% black	The Closed Caption Text mode is on. Turn it off in the CLOSED CAPTION Menu, see page 61.
Stereo or bilingual programs cannot be heard	Make sure the MTS settings are correct. See "MTS" on page 51.
You hear occasional crackling sounds	It is normal for the TV to make crackling sounds when first turned on or off. Unless the sound or picture becomes abnormal, this is fine.

The following are not malfunctions.

- The television may make a creaking sound if the temperature of the room or the temperature of the inside of the television changes. If there is no problem with the screen or sound, then there is no need to worry.
- Although the picture may be temporarily disturbed and noise may be seen on the screen if the power is turned on immediately after it has been turned off, this is not a malfunction.
- If the television is used at a location above 2,000 m, a buzzing noise and image distortion may occur. This phenomenon is peculiar to PDP (Plasma Display Panel), and could occur with any television using PDP. It is not a malfunction.

Caring for the Cabinet

Normally, light dusting with a soft, non-scratching duster will keep your TV clean.

If you wish to wipe down the television, first unplug it. Then wipe gently with a soft cloth, slightly moistened with water. You can add a few drops of mild liquid detergent to the water to help remove spots of oily dirt.

DO NOT allow liquid to enter the TV through the ventilation slots.

DO NOT use strong or abrasive cleaners on the TV.

DO NOT spray liquids or cleaners directly on the TV's surface.

DO NOT rub or scrub the TV harshly. Wipe the set gently with a soft cloth.

Caring for the Screen

When it gets dirty, wipe it gently with a soft cloth.

Do not apply alcohol, organic solvents (like acetone), acidic or alkaline cleansers to the screen. These will remove the coating layer and cause discolorations.

JVC COMPANY OF AMERICA warrants this product and all parts thereof, except as set forth below **ONLY TO THE ORIGINAL PURCHASER AT RETAIL** to be **FREE FROM DEFECTIVE MATERIALS AND WORKMANSHIP** from the date of original retail purchase for the period shown below. ("The Warranty Period")

PARTS 1 YEAR	LABOR 1 YEAR
---------------------	---------------------

This limited warranty is valid only in the fifty (50) United States, The District of Columbia and Commonwealth of Puerto Rico.

WHAT WE WILL DO:

If this product is found to be defective within the warranty period, JVC will repair or replace defective parts at no charge to the original owner. Such repair and replacement services shall be rendered during regular business hours by JVC authorized service centers. Parts used for replacement are warranted only for the remainder of this Warranty Period. Televisions with a screen size of 25 inches and larger are covered on an in-home basis.

WHAT YOU MUST DO FOR WARRANTY SERVICE:

Either contact the selling dealer (retailer) or call 1-800-252-5722 to arrange In-home service. In-home service will require clear access to the Television by the service technician.

WHAT IS NOT COVERED:

This limited warranty provided by JVC does not cover:

1. Products which have been subject to abuse, accident, alteration, modification, tampering, negligence, misuse, faulty installation, lack of reasonable care, or if repaired or serviced by anyone other than a service facility authorized by JVC to render such service, or if affixed to any attachment not provided with the products, or if the model or serial number has been altered, tampered with, defaced or removed. If the upper unit is removed from the lower unit by anyone other than a dealer or service facility authorized by JVC.
2. Initial installation, installation and removal from "built-in" entertainment centers and other mounting systems.
3. Operational adjustments covered in the Owner's Manual, normal maintenance, including head cleaning.
4. Damage that occurs in shipment, due to an act of God, and cosmetic damage.
5. Signal reception problems and failures due to line power surge.
6. Products used for commercial purposes (including but not limited to rental).
7. Accessories.
8. Batteries (except that Rechargeable Batteries are covered for 90 days from date of purchase).

There are no express warranties except as listed above.

Warranty



THE DURATION OF ANY IMPLIED WARRANTIES, INCLUDING THE IMPLIED WARRANTY OF MERCHANTABILITY, IS LIMITED TO THE DURATION OF THE EXPRESS WARRANTY HEREIN.

JVC SHALL NOT BE LIABLE FOR THE LOSS OF USE OF THE PRODUCT, INCONVENIENCE, OR ANY OTHER DAMAGES, WHETHER DIRECT, INCIDENTAL OR CONSEQUENTIAL (INCLUDING, WITHOUT LIMITATION, DAMAGE TO TAPES, RECORDS OR DISCS) RESULTING FROM THE USE OF THIS PRODUCT, OR ARISING OUT OF ANY BREACH OF THIS WARRANTY, ALL EXPRESS AND IMPLIED WARRANTIES, INCLUDING THE WARRANTIES OF MERCHANTABILITY AND FITNESS FOR PARTICULAR PURPOSE, ARE LIMITED TO THE WARRANTY PERIOD SET FORTH ABOVE.

Some states do not allow the exclusion of incidental or consequential damages or limitations on how long the warranty lasts, so these exclusions or limitations may not apply to you. This warranty gives you specific legal rights and you may also have other rights which vary state to state.

JVC COMPANY OF AMERICA
DIVISION OF JVC AMERICAS CORP.

1700 Valley Road
Wayne, New Jersey 07470

<http://www.jvc.com>

REFURBISHED PRODUCTS CARRY A SEPARATE WARRANTY. THIS WARRANTY DOES NOT APPLY. FOR DETAILS OF REFURBISHED PRODUCT WARRANTY, PLEASE REFER TO THE REFURBISHED PRODUCT WARRANTY INFORMATION PACKAGED WITH EACH REFURBISHED PRODUCT.

For customer use:

Enter below the Model No. and Serial No. which is located either on the rear, bottom or side of the cabinet.

Retain this information for future reference.

Model No.: _____

Serial No.: _____

Purchase Date: _____

Name Of Dealer: _____

Authorized Service Centers

QUALITY **JVC** SERVICE
HOW TO LOCATE YOUR JVC SERVICE CENTER
TOLL FREE: 1 (800) 537-5722
<http://www.jvc.com>

Dear Customer,

In order to receive the most satisfaction from your purchase, please read the instruction booklet before operating the unit. In the event that repairs are necessary, call our Customer Relations Department at 1-800-537-5722 or visit our website at **www.JVC.com**

Remember to retain your Bill of Sale for Warranty Service.

Don't service the television yourself

Caution

To prevent electrical shock, do not open the cabinet. There are no user serviceable parts inside. Please refer to qualified service personnel for repairs.

Accessories

To purchase accessories for your JVC product, please call toll free:1 (800) 882-2345 or on the web at **www.JVC.com**

Specifications

MODEL	PD-42WX84
Type	Plasma Display
Reception Format	NTSC, BTSC System (Multi-Channel Sound) 1080i DTV digital broadcast ready
Reception Range	VHF 2 to 13, UHT 14 to 69 Sub, Mid, Super, Hyper et Ultra bands (180 channel frequency synthesizer system)
Power Source	AC 120V, 60Hz
Power Consumption	TV : 365W
	Receiver : 29W
Screen Size	42 inch / 107.5 cm measured diagonally, 16:9 ratio
Audio Output	18W + 18W
Speakers	DD speaker (3 3/4 x 7/16 inch / 9.5 cm x 1 cm) oval x 2 Tweeter: (13/16 inch / 2 cm) round x 2 Woofer (5 1/8 x 2 9/16 / 13 cm x 6.5 cm) oval x 2
Antenna Terminal	75 ohms (VHF/UHF) (F-type connector)
External Input Jacks	Video : 1Vp-p, 75 ohms Audio : 500mVrms (-4dBs) high impedance
S-Video Input Jacks	Y : 1Vp-p positive, 75 ohms (negative sync provided) C: 0.286 Vp-p (burst signal), 75 ohms
Component Input Jacks	Y : 1Vp-p positive, 75 ohms (negative sync provided) Ps/Pr: 0.7 Vp-p, 75 ohms
Audio Output Jacks (VARI/FIX)	VARI: More than 0 to 1000mVrms (+2.2 dBs) FIX: 500mVrms (-4dBs) Low impedance (400 Hz when modulated 100%)
Subwoofer Output Jack	More than 0 to 1000mVrms (+2.2 dBs) Low impedance (100 Hz when modulated 100%)
AV Compu Link III Jack	3.5 mm mini jack x 1
Digital-In	DVI-D single Link 19 pin Note: The Digital-In terminal is not compatible with picture signals of a personal computer
Dimensions W X H X D	TV: 45 11/16 x 31 7/16 x 12 3/16 inch / 1160 x 798 x 308mm (with the stand) 45 11/16 x 28 13/16 x 3 7/8 inch / 1160 x 731 x 98 mm (main TV body)
	Receiver : 17 3/16 x 3 15/16 x 15 1/16 inch / 435 x 99 x 382 mm
Weight	TV: 106 lbs / 48 kg (with the stand) 84 lbs / 38 kg (main TV body)
	Receiver : 11.3 lbs / 5.1 kg
Accessories	Refer to "Unpacking your TV" on page 10.

Specifications subject to change without notice.

Notes

JVC COMPANY OF AMERICA
Division of JVC Americas Corp.
1700 Valley Road
Wayne, New Jersey, 07470



JVC CANADA, INC.
21 Finchdene Square
Scarborough, Ontario
Canada, M1X 1A7