

# Concerning Compact Discs

Only compact discs bearing this mark can be used with this unit.



However, continued use of irregular shape CDs (heart-shape, octagonal, etc.) can damage the unit.

CD-R and CD-RW discs recorded with the audio CD format can be played back, though some may not be played back because of the disc characteristics or recording condition.

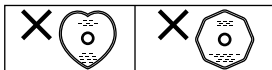

## How to remove a disc from its case

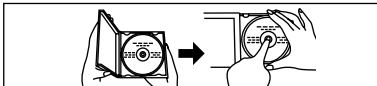

## How to store the disc in its case

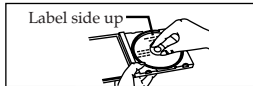

## How to hold a disc

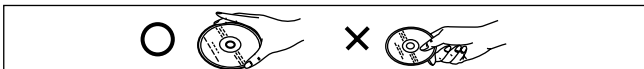

## If the disc surface is dirty

Wipe it with a damp cloth and then wipe dry. Wipe from the center toward the outer edge.

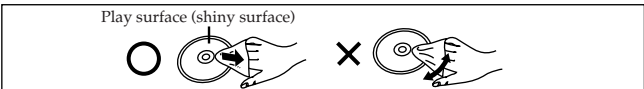

## If moisture has formed on a disc

When moisture has formed because the disc was brought suddenly into a warm room from a cold environment, wipe off the moisture using a soft dry cloth.

## When storing discs

Avoid locations which are

- Exposed to direct sunlight.
- Susceptible to high levels of humidity or dust.
- Directly exposed to heat from a heating appliance.
- On top of a car dashboard or near the rear window.

## Handling precautions

- On the label side (the side with writing) Do not write anything using a pencil, ball-point pen, etc. Do not use adhesive paper or labels.
- On the disc (shiny) side Handle this side carefully to keep it free from fingerprints or scratches. Do not use record cleaners, solvents, etc.
- Do not attach labels or stickers to CDs. Do not use CDs with exposed adhesive from tape or left over peeled off stickers.
- Do not use scratch-proof protectors or covers other than those specified for use with this unit.

# Precautions

Before using this unit, be sure to read the applicable items of the operating instructions and these safety-suggestions carefully. Afterwards keep them handy for future reference. Take special care to follow the warnings indicated on the unit itself as well as in the operating instructions.

## Safety

- Care of AC adaptor** - The cord of the AC adaptor should be routed so that they are not likely to be walked on or pinched by items placed upon or against them. Never take hold of the AC adaptor if your hand is wet, and always grasp the plug when connecting or disconnecting it.
- Disconnect when not in use** - When not in use, be sure to disconnect the AC adaptor from the AC power outlet.
- Batteries** - If the set is not used for a long period of time or is used only from an AC power source, remove all the batteries to prevent potential damage due to battery leakage. Do not mix (old and new) batteries or different types of batteries.

## Installation

### Environment

- Condensation** - Moisture may form on the lens in the following conditions...
  - immediately after a heater has been turned on.
  - in a steamy or very humid room.
  - when the unit is suddenly moved from a cold environment to a warm one. If moisture forms inside this unit, it may not operate properly. To correct this problem wait about one hour for the moisture to evaporate.

### Placement

- Foreign Material** - Care should be taken so that objects do not fall into and liquids are not spilled into the unit. Do not subject this unit to excessive smoke, dust, mechanical vibration, or shock.
- Magnetism** - The unit should be situated away from equipment or devices that generate strong magnetic fields.
- Stacking** - Do not place any objects on top of the unit.

## Maintenance

(See page 3 for details.)

Clean the cabinet, panel and controls with a soft cloth lightly moistened with mild detergent solution. Do not use any type of abrasive pad, scouring powder or solvent such as alcohol or benzene.

## Service

- Damage Requiring Service** - The unit should be serviced by qualified service personnel when:
  - (a) The AC adaptor is damaged; or
  - (b) Objects have fallen or liquid has been spilled into the unit; or
  - (c) The unit has been exposed to rain; or
  - (d) The unit does not appear to operate normally or exhibits a marked change in performance; or
  - (e) The unit has been dropped, or the enclosure damaged.

## WARNING:

TO REDUCE THE RISK OF FIRE OR ELECTRIC SHOCK, DO NOT EXPOSE THIS APPLIANCE TO RAIN OR MOISTURE.

## CAUTION!

THIS PRODUCT UTILIZES A LASER. USE OF CONTROLS OR ADJUSTMENTS OR PERFORMANCE OF PROCEDURES OTHER THAN THOSE SPECIFIED HEREIN MAY RESULT IN HAZARDOUS RADIATION EXPOSURE. DO NOT OPEN COVERS AND DO NOT REPAIR YOURSELF. REFER SERVICING TO QUALIFIED PERSONNEL.

- CLASS 1 LASER PRODUCT**
- DANGER:** Invisible laser radiation when open and interlock failed or defeated. Avoid direct exposure to beam.
- CAUTION:** Do not open the top cover. There are no user serviceable parts inside the unit; leave all servicing to qualified service personnel.

# JVC

## PORTABLE CD PLAYER XL-PM25BK

### For Customer Use:

Enter below the Model No. and Serial No. which are located either on the rear, bottom or side of the player. Retain this information for future reference.

Model No. \_\_\_\_\_  
Serial No. \_\_\_\_\_

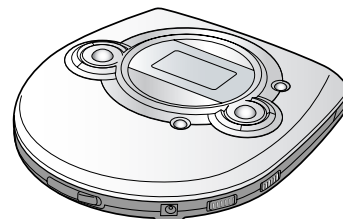

## INSTRUCTIONS

### Supplied Accessories

Check the packing carton for these accessories.

AC adaptor (AA-R4513) .....	1 pc.
Stereo headphones .....	1 pc.
Remote control .....	1 pc.
Rechargeable batteries (BN-R1211) .....	2 pcs.

Use numbers in parentheses when asking for replacement parts.

Thank you for purchasing this JVC product. Please read these instructions carefully before starting operation to be sure to obtain optimum performance and a longer service life from the unit.



0403SKMCREORI

LVT0997-001A [J,C]

THE FOLLOWING NOTICES ARE APPLIED ONLY FOR THE U.S.A.:

**POWERED BY NICKEL-CADMIUM BATTERY. MUST BE RECYCLED OR DISPOSED OF PROPERLY.**

### ATTENTION:

The product that you have purchased is powered by a rechargeable battery. The battery is recyclable. At the end of its useful life, under various state and local laws, it may be illegal to dispose of this battery into the municipal waste stream.

Check with your local solid waste officials for details in your area for recycling options or proper disposal.



Ni-Cd



## CAUTION!

This equipment has been tested and found to comply with the limits for a Class B digital device, pursuant to Part 15 of the FCC Rules.

These limits are designed to provide reasonable protection against harmful interference in a residential installation. This equipment generates, uses and can radiate radio frequency energy and, if not installed and used in accordance with the instructions, may cause harmful interference to radio communications. However, there is no guarantee that interference will not occur in a particular installation. If this equipment does cause harmful interference to radio or television reception, which can be determined by turning the equipment off and on, the user is encouraged to try to correct the interference by one of the following measures:

- Reorient or relocate the receiving antenna.
- Increase the separation between the equipment and receiver.
- Connect the equipment into an outlet on a circuit different from that to which the receiver is connected.
- Consult the dealer or an experienced radio/TV technician for help.

Any unauthorized changes or modifications to this equipment would void the user's authority to operate this device.

# Cautions

## Listening precautions



Do not play your headphones or earphones at a high volume. Hearing experts advise against continuous extended play.

If you experience a ringing in your ears, reduce volume or discontinue use.

Do not use while operating a motorized vehicle. It may create a traffic hazard and is illegal in many areas.

You should use extreme caution or temporarily discontinue use in potentially hazardous situations.

Even if your headphones or earphones are an open-air type designed to let you hear outside sounds, don't turn up the volume so high that you can't hear what's around you.

Sound can be deceiving. Over time your hearing "comfort level" adapts to higher volumes of sound. So what sounds "normal" can actually be loud and harmful to your hearing.

Guard against this by setting your equipment at a safe level BEFORE your hearing adapts.

To establish a safe level:

- Start your volume control at a low setting.
- Slowly increase the sound until you can hear it comfortably and clearly, and without distortion.

Once you have established a comfortable sound level:

- Set the dial and leave it there.

## Rechargeable batteries

- Only the BN-R1211J battery can be recharged.
- If the power delivered by the batteries lasts for a very short time after recharging, it means that the batteries' service life is over. Do not use them any more.
- Recharging already charged batteries will shorten their service life.
- When recharging batteries for the first time or when they have not been used for a long period of time, the play time may be shorter than usual. In a case like this, repeatedly recharge and discharge the batteries. This will restore them to their regular state.
- Do not allow any metal objects to touch the terminals of rechargeable batteries since this may cause short-circuiting which is dangerous.
- Do not peel off the plastic covering on the rechargeable batteries. Short-circuiting may occur which is dangerous.

## Dry cell batteries / rechargeable batteries

To prevent damage to the batteries and electrolyte leakage, heed the following points.

- Align the ⊕ and ⊖ polarities properly when inserting the batteries.
- Do not mix different types or makers of batteries or old and new batteries.
- Remove the batteries if you do not plan to use the unit for a long period of time.
- Do not throw batteries into a fire, and do not short-circuit, disassemble or subject them to excessive heat.
- Do not attempt to recharge dry cell batteries.

## Carrying dry cell batteries / rechargeable batteries around

When putting dry cell or rechargeable batteries in a pocket or bag, ensure that no other metal objects such as a necklace are placed together with them. Contact with metal may cause short-circuiting which, in turn, may cause a fire.

## When purchasing rechargeable batteries

As a safety precaution, the portable CD players made by JVC have a construction designed to make it impossible to recharge ordinary batteries.

To use rechargeable batteries, be absolutely sure to purchase the rechargeable Ni-Cd batteries designed especially for this unit.

### Special rechargeable Ni-Cd batteries:

**BN-R1211J (set of 2)**

For details, check with your dealer.

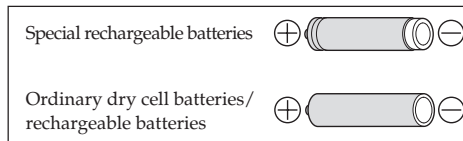

### INFORMATION (For Canada)

This digital apparatus does not exceed the Class B limits for radio noise emissions from digital apparatus as set out in the interference-causing equipment standard entitled "Digital Apparatus", ICES-003 of the Department of Communications.

# Specifications

## Portable CD player

Type	: Compact disc player
Signal detection system	: Non-contact optical pickup (semiconductor laser)
Pickup system	: 3 beam laser
Number of channels	: 2 channels (stereo)
Frequency response	: 20 Hz to 20 000 Hz
Wow & flutter	: Unmeasurable
Output	: Headphones (3.5 mm dia. stereo × 1) 9 mW/ch at 10 % THD/16 Ω matching impedance (16 Ω to 1 kΩ) LINE OUT (3.5 mm dia. stereo × 1) 0.6 V/50 kΩ
Duration of battery (with Aanti-Shock Protection OFF)	: Approx. 3 hours when using two rechargeable batteries (BN-R1211J) charged for 10 hours, Approx. 20 hours when using two alkaline batteries (LR6)
Power requirements	: DC 3 V ("AA" size battery × 2) DC 2.4 V (rechargeable battery × 2) DC IN 4.5 V
Dimensions (W×H×D)	: 134.0 mm × 26.5 mm × 140.0 mm (5 <sup>-5</sup> / <sub>16</sub> " × 1 <sup>-1</sup> / <sub>16</sub> " × 5 <sup>-9</sup> / <sub>16</sub> " ) (Excluding buttons and controls)
Mass	: Approx. 270 g (0.6 lbs) (without batteries)

## AC adaptor

Input power source	: AC 120 V, 60 Hz
Output voltage	: DC 4.5 V, 600 mA

\* Design and specifications are subject to change without notice.

# Maintenance

## Unit

Wipe the unit with a soft cloth. Remove stubborn dirt using a cloth which has been dipped in water or soapy water and wrung out, and then wipe dry.

- If you intend to use a chemically treated cleaning cloth, read its directions first.
- Do not use alcohol or paint thinners.

## Lens

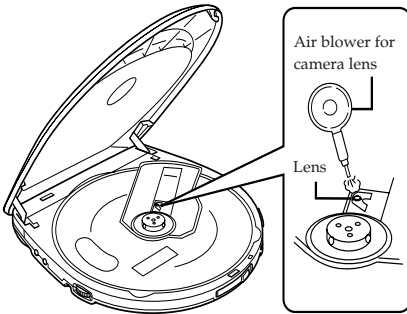

# Troubleshooting

Symptom	Check this
<b>Does not turn on.</b>	<ul style="list-style-type: none"> <li>• Are the batteries charged?</li> <li>• Is the AC adaptor securely connected?</li> <li>• Is the HOLD switch set to OFF position?</li> </ul>
<b>Cannot close lid.</b>	Is the disc properly secured in place?
<b>Cannot play discs.</b>	<ul style="list-style-type: none"> <li>• Is the disc properly secured in place?</li> <li>• Is there moisture condensation on the lens? (Wait for about an hour and then try again.)</li> <li>• Are MP3 files recorded on the disc?</li> <li>• Do MP3 files have the extension code—.mp3?</li> <li>• Are MP3 files recorded in the format compliant with ISO 9660?</li> </ul>
<b>Cannot hear music —too noisy.</b>	<ul style="list-style-type: none"> <li>• Is the headphone correctly connected?</li> <li>• Is the plug dirty? (Wipe away dirt on the plug.)</li> <li>• Are you playing a compatible disc? While playing a non-MP3 file, you will hear a noise. (Note it may not be an MP3 file although it has the extension code—.mp3.)</li> </ul>
<b>TV picture is distorted. Radio reception is noisy.</b>	Are you using the unit too near a TV or tuner? (If the TV or tuner is connected to a simple indoor antenna, connect it to an outdoor antenna.)
<b>“NO DISC” or “Error” is displayed when a disc is in the player.</b>	<ul style="list-style-type: none"> <li>• Is the disc damaged?</li> <li>• Is the disc playable on this player?</li> <li>• Has the disc been inserted upside down?</li> </ul>

If the remedies indicated in the chart do not solve the problem, refer to the directory of Authorized Service Centers (enclosed with this unit) to locate a convenient service center, or consult your dealer.

# Location of Controls

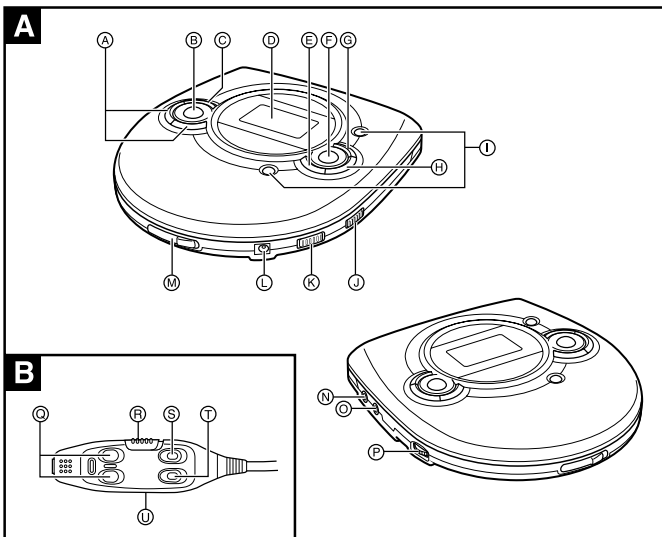

## Portable CD player **A**

- A** GROUP buttons (UP, DOWN)
- B** Stop / power off button (■)
- C** PROGRAM button
- D** Display
- E** MODE button
- F** Play / pause button (▶/||)
- G** SOUND button  
In addition to sound effect selection, you can turn on/off HBS (Hyper-Bass Sound).
- H** A.S.P. (Anti-Shock Protection) / T.SEARCH (Title Search) button
- I** Skip / search buttons (◀◀, ▶▶)
- J** HOLD switch
- K** RESUME switch
- L** DC in jack (DC IN 4.5 V ⚡)
- M** Lid open switch (OPEN ▶)
- N** LINE OUT jack
- O** Headphones jack (🎧)
- P** Headphones volume control (VOLUME)

## Remote control **B**

- Q** Skip / search buttons (+, -)
- R** HOLD switch
- S** Stop / off button (■)
- T** Play / pause button (▶||)
- U** Volume control

# Display

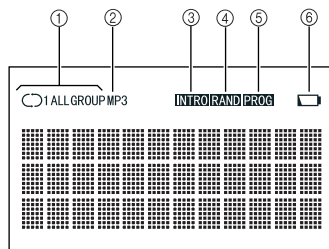

- 1** Repeat indicator (See page 7)
- 2** MP3 indicator  
Lights when a MP3 disc is used.
- 3** INTRO indicator (See page 7)
- 4** RAND (Random) indicator (See page 7)
- 5** PROG (Program) indicator (See page 7)
- 6** Battery indicator (See page 4)

# Power Supply Preparations

## Using rechargeable batteries (supplied)

Be sure to recharge the rechargeable batteries before using them.

### Recharging procedure

#### 1 Insert the rechargeable batteries.

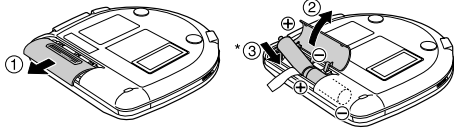

\* Insert the battery as you push it in the indicated direction.

#### Caution:

Do not forcibly open the battery lid too wide.

#### 2 Connect the AC adaptor (supplied).

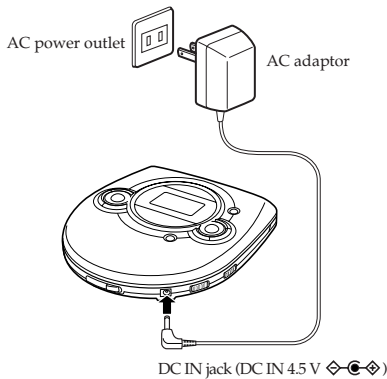

Recharging will be completed after 10 hours.

#### 3 When recharging is complete, unplug the AC adaptor from the AC power outlet and the DC IN jack.

#### Notes:

- Rechargeable batteries have a service life of approximately 300 charge-discharge cycles. If the operating time on one full charge becomes noticeably shorter than it used to be, the batteries have reached the end of their service life and should be replaced.
- You can recharge the batteries only when the unit is turned off.
- The AC adaptor and rechargeable batteries may become warm while recharging is in progress. This is normal and is not a malfunction.

**If the battery lid compartment comes loose**  
Slide the lid back into place horizontally.

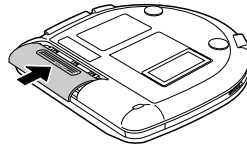

#### Removing batteries

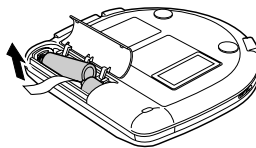

## Using the AC adaptor (supplied)

### Connect the AC adaptor.

Refer to "Using rechargeable batteries" for connection instructions.

#### Note:

Even if the unit is turned off, small power is consumed as long as the AC adaptor is connected to the AC power outlet.

## Using dry-cell batteries (not supplied)

After disconnecting the AC adaptor, insert two "AA" (LR6) alkaline batteries.

The procedure for inserting and removing dry-cell batteries is identical to that rechargeable batteries.

## Battery indicator

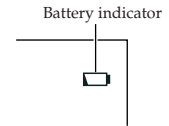

This indicator lights when the batteries are almost out of power. Power will be shut off a short while later.

#### Note:

Turning off the Anti-Shock Protection (see page 6) will save the battery power more or less. (Available for an Audio CD only)

**If the unit malfunctions or freezes during use, disconnect the AC adaptor and batteries. Then, connect the AC adaptor and batteries, and operate the unit again.**

# About MP3 files

## MP3 File Compatibility

- This player can read MP3 files that are recorded in the format that is compliant with ISO 9660.
- The player can read or play an MP3 file with the extension code —".mp3".
- Group/track title can be displayed.
- ID3\* tags can be shown on the display.
- \* An MP3 file can contain file information called "ID3 Tag" where its album name, artist, title, etc. are recorded. This player can handle only one-byte characters. Any other characters cannot be correctly displayed.

## Playing order of MP3 files

The illustration below shows the normal playing order of the MP3 files. You will see that the MP3 files are played back in the order from the higher hierarchy to the lower one.

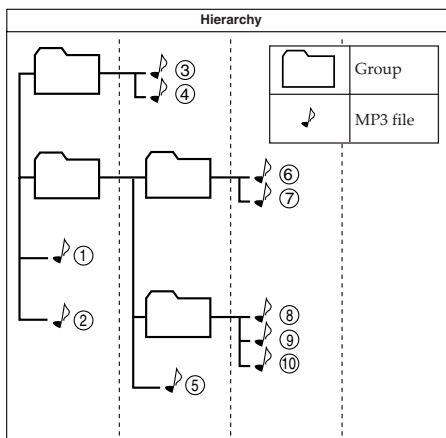

# Basic Play

This CD player can play back Audio CDs and MP3 files (tracks).

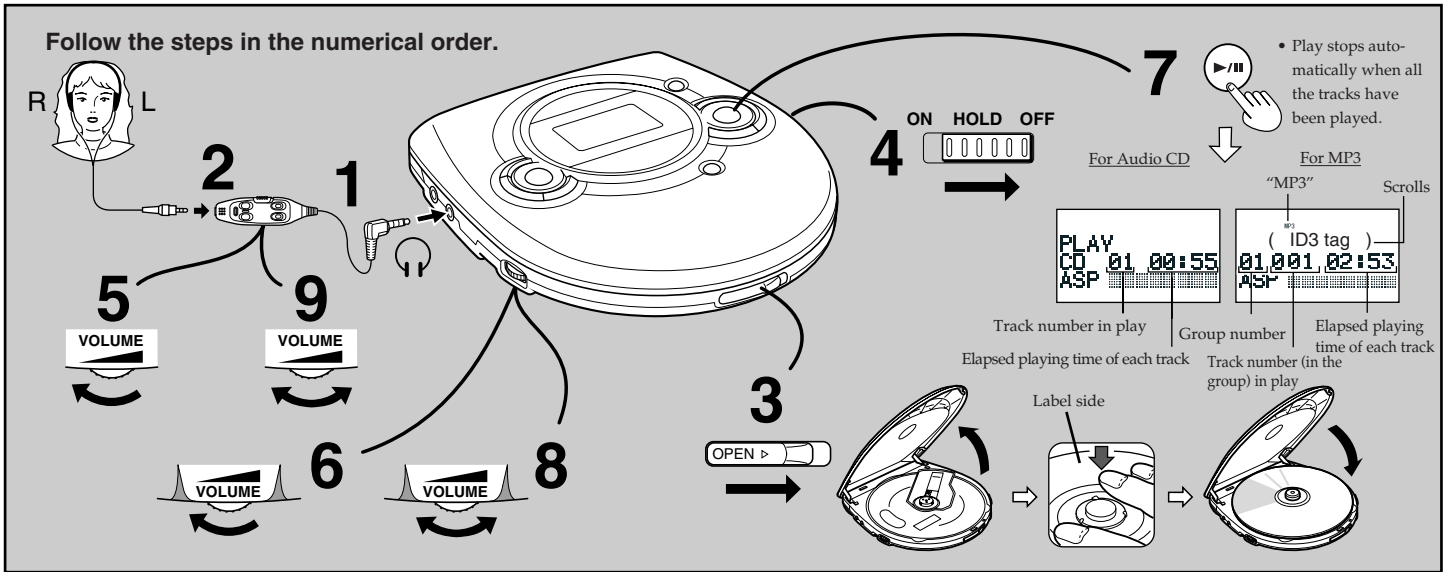

Operation	Button	Display/reference	
		Audio-CD	MP3
To pause play	<p>During play,</p> <p>Press again to restart play.</p>		
To stop play Stop mode	<p>During play,</p>	<p>Total playing time</p> <p>Total number of tracks</p>	<p>Total number of tracks</p> <p>Total number of groups</p>
To turn off the unit Off mode	<p>In stop mode,</p>		
Fast forward/reverse	<p><b>Skip function</b></p> <p>During play,</p> <p>Forward</p> <p>Reverse</p> <p><b>Search function</b></p> <p>Keep depressing during play.</p>	<ul style="list-style-type: none"> <li>To skip back to the previous track, quickly press  twice.</li> <li>During Program play, the button is used to fast forward or back through the programmed sequence of tracks.</li> <li>During Random play, the skip button cannot be used to skip back to tracks that were played previously in the random sequence.</li> </ul>	
Group skip (MP3 only)	<p>During play (except Random play) or in stop mode,</p> <p>Reverse</p> <p>Forward</p> <p>DOWN - [GROUP] - UP</p>	<p>Group skips.</p> <p>Group number</p>	
Track skip (MP3 only)	<p>During play (except Random play) or in stop mode, keep depressing.</p> <p>Reverse</p> <p>Forward</p> <p>DOWN - [GROUP] - UP</p>	<p>Track number quickly changes over the groups.</p> <p>Track number</p>	
Showing the group title (MP3 only)	<p>During play, keep depressing.</p> <p>MODE</p>	<p>To cancel it, keep MODE depressing again.</p>	

## File name and ID3 tag display (MP3 only):

During playback, the file name and ID3 tag scroll on the display as follows:

File name ⇒ ID3 tag (Title ⇒ Artist ⇒ Album) ⇒ ID3 tag (Title ⇒ Artist ⇒ Album) ⇒ .....

- The file name scrolls at first only. Then, the ID3 tag repeatedly scrolls.
- For the ID3 tag, the Title, Artist and Album scroll in that order.

## For your reference:

### "NO DISC"

This indication appears if is pressed when no disc is loaded in the unit or if the disc is not properly seated.

### "OPEN"

This indication appears when the lid is open.

## Removing the disc

Turn off the unit and, after the disc has stopped rotating, remove the disc as shown below:

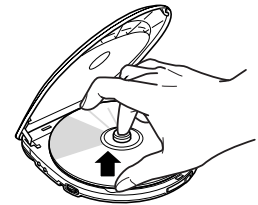

## Auto power off function

If the unit is left in stop mode for 30 seconds, the unit turns itself off automatically to save power.

## Anti-Shock Protection

This function minimizes sound interruption caused by vibrations, by utilizing audio data that has been stored in the memory ahead of the following time:

For Audio CD: Up to 45 seconds worth (Anti-Shock Protection on/off selectable)

For MP3: Up to 120 seconds worth at 128 kbps (Anti-Shock Protection is fixed to on.)

Normally, "ASP" and the A.S.P. progress meters are displayed and the Anti-Shock Protection is in effect.



A.S.P. indicator

When the disc is played, as the audio data gradually stored in the memory, the A.S.P. progress meter progresses.



### To cancel (Audio CD only)

Press the A.S.P./T.SEARCH button in stop mode or during playback. "ASP OFF" appears on the display.

### To activate again (Audio CD only)

Press the A.S.P./T.SEARCH button.

#### Notes:

- The Anti-Shock Protection can be enabled or disabled during play, and this may cause a slight interruption in the sound because the disc's rotational speed changes.
- Turning off the Anti-Shock Protection will save battery life more or less.

## Preventing Accidental Operation (Hold mode)

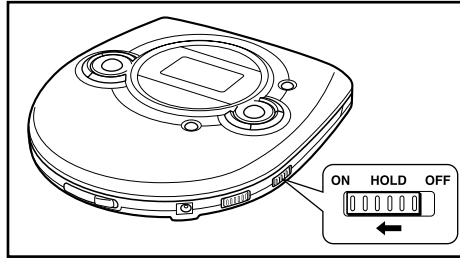

The HOLD switch on the unit/remote control is prepared to prevent an accidental operation by an unexpected button press.

### Hold mode prevents the following:

- Powering on the unit accidentally (which can cause the batteries to go dead).
- Play being cut off unexpectedly.
- Unexpected operation during play. (Set the HOLD switch to the ON position after you start playing disc.)

### To set the unit/remote control in Hold mode

- Set the HOLD switch on the unit/remote control to the ON position. The all buttons on the unit/remote control are disabled.

### "HOLD" indication

When the unit is in Hold mode, "HOLD" will be displayed if a button on the unit is pressed.

### To release the Hold mode

Set the HOLD switch to OFF position.

#### Notes:

- Before turning on the unit, be sure that HOLD is OFF. Otherwise, you cannot turn on the unit.
- The HOLD switch on the unit is effective for the unit only. While, that on the remote control is effective for the remote control only.

## Using the Remote Control

### Preparation:

Release the remote control from the Hold mode.

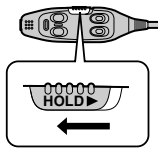

### How to use the remote control

To start play	Press during off or stop mode. 
To stop play	Press during play. 
To turn off the unit	Press during stop mode. 
Fast forward/reverse	<b>Skip function</b> Press during play. Forward Reverse <b>Search function</b> Keep depressed during play.
To adjust the volume	When adjusting the volume using the remote control, set the volume control on the unit to an appropriate position. 

## Using with an audio system

You can use an audio system by connecting it to the unit with a stereo connection cable (not supplied).

- Connect the cable to the amplifier after turning off its power.
- Do not connect the cable to the PHONO jacks on the amplifier.
- Obtain the optional connecting cable if the amplifier comes with mini-phone jacks.
- Adjust the volume level on the amplifier.

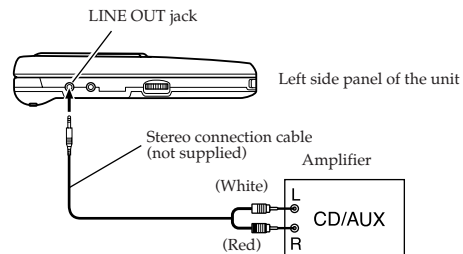

#### Note:

To obtain original sound, turn HBS to OFF. Also, set the sound effect to "FLAT". (See page 7)

# Other Play Methods

Descriptions are common to Audio CDs and MP3 files unless otherwise noted.

## Random play

You can play all tracks in a random order. After playing all tracks, the unit stops.

During playback,

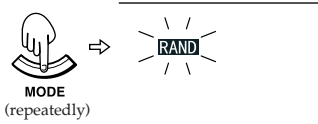

To cancel

Press MODE. "RAND" goes out.  
Or press to stop playback.

### Notes:

- You can also select Random play in stop mode.
- During Program play, you can not select Random play.

## Repeat play

You can repeatedly play one track or one group (for MP3), or all tracks.

During playback,

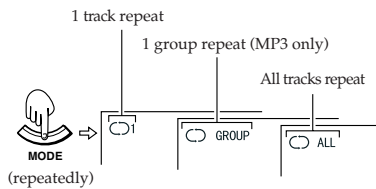

To cancel

Press MODE repeatedly until the repeat indicator goes out.

### Notes:

- You can also select Repeat play in stop mode.
- You can also select Repeat play during Program play (except 1 group repeat).

## Intro play

You can successively play the first 10 seconds of every track. Intro play stops after playing the last track.

1 In stop mode,

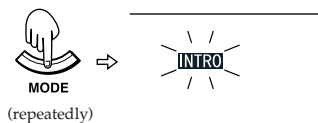

2



Intro play will start from the first track.

To cancel

Press MODE repeatedly until "INTRO" goes out.

### Notes:

- You can also select Intro play during playback. In this case, Intro play after the current track has been played back.
- You can also select Intro play during Program play.

## Program play

You can program up to 64 tracks in any desired order including the same tracks.

For Audio CD, go to step 3. Though the display differs a little, operation is the same.

During playback or in stop mode,

1 (MP3 only)

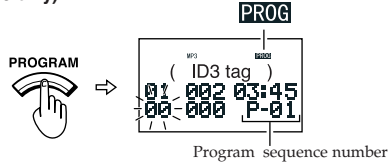

2 (MP3 only) Select the desired group number. (e.g. 02)

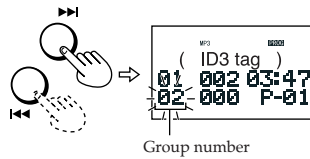

3

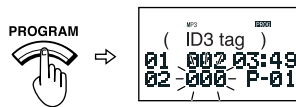

4 Select the desired track. (e.g. 03)

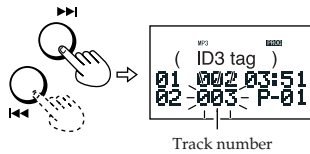

5

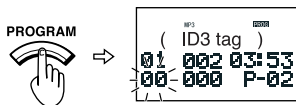

6 For MP3, repeat steps 2-5 to select other tracks.  
For Audio-CD, repeat steps 4 and 5.

7



• To confirm the program

In stop mode, press PROGRAM repeatedly. The programmed track number will successively appear together with the program sequence number. At this time, you can change the program, if required.

If the programmed tracks are less than 64, track number "00 000" appears for the youngest programmable sequence number, enabling further programming.

• To delete the entire program

Set RESUME to "OFF", then turn off the unit.

## RESUME

This function allows you to listen from the beginning of the track that was lastly stopped.

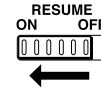

Press to resume playback.

- The setting (e.g. sound effect, etc.) are also resumed.
- To cancel, set RESUME to "OFF".

## Sound effect

You can enjoy various sound effects.



Each time you press,

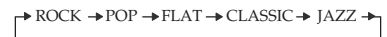

## Hyper-Bass Sound effect

You can enjoy powerful bass sound.



(Keep depressing)



To cancel

Keep depressing SOUND. "HBS" will go out.

## Title search (MP3 only)

### File search (Alphabet search)

You can search a track title you want by specifying up to first five characters. For example, to search the track title "CHAMPION", you can specify "C", "CH", etc. In the following example, "CH" are specified.

- Note that search is made for the track title (file name) and not for the ID3 tag.

#### 1 In stop mode or during playback,

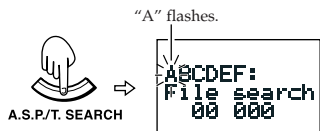

#### 2 Enter the characters "CH", for example.

- 1) Press ►► or ◀◀ repeatedly to select "C". ("C" flashes.)
- 2) Press ►/|| to enter "C".

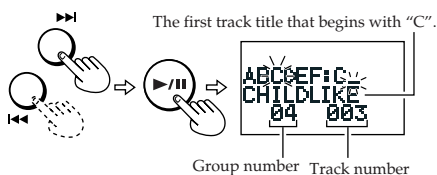

- If no track title begins with "C", "NO File" is displayed. In this case, press ■ to cancel the character.
- When you specify only the first letter of the track title, skip the following step 3), 4), 5) and proceed to 3).

- 3) Keep depressing ►► until "GHIJKL:" is displayed for entering the next character "H".

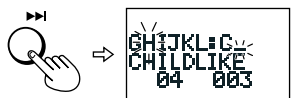

Each time ►► or ◀◀ is kept depressing, the character set cyclically changes as follows:

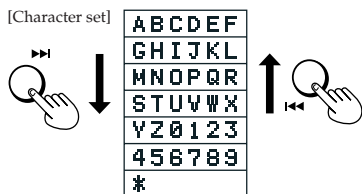

- 4) Press ►► or ◀◀ to select "H".

- 5) Press ►/|| to enter "H".

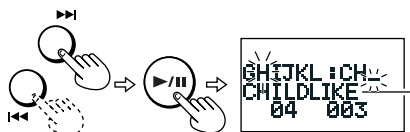

- If no track title begins with "CH", "NO File" is displayed. In this case, press ■ to cancel the character.

#### 3 Select the track title you want.



- 2) Select the track title you want.

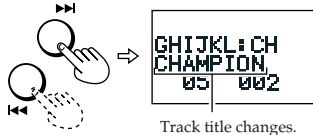

- By pressing SOUND, you can scroll the track title. To cancel scrolling, press SOUND again.
- If there is only one track that begins with "CH", the track title does not change.



The selected track starts playback.

#### Notes:

- To exit the File search (Alphabet search) mode, press ■ or A.S.P./T.SEARCH repeatedly at any time to return to the normal display.
- When playback starts, the File search (Alphabet search) mode is automatically released.
- If you leave the unit for more than 30 seconds during operation, the File search mode will be cancelled and the display returns to the normal one.

### Group search

You can search a group you want to play.

Search is made for the group title (folder name) and not for the ID3 tag.

#### 1 In stop mode or during playback,

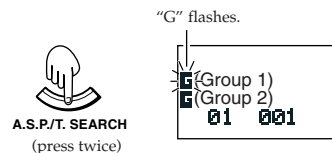

#### 2 Press ►► or ◀◀ repeatedly until the group you want is displayed on the first line.

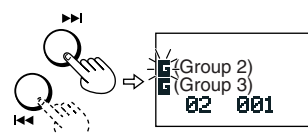

- When you want to play from the first track of the group, skip the following 3 and 4, and proceed to 5.

#### 3 To specify a track in the group, keep depressing ►► or ◀◀ until the letter "T (Track)" is displayed.

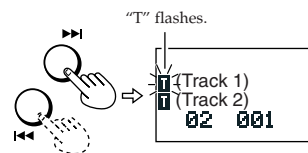

- By pressing SOUND, you can scroll the group title and track title. To cancel scrolling, press SOUND again.

#### 4 Press ►► or ◀◀ until the track title you want is displayed on the first line.



Playback starts from the selected track of the selected group. When playback starts, the Group search mode is automatically released.

#### Notes:

- To exit the Group search mode, press ■ or A.S.P./T.SEARCH at any time to return to the normal display.
- When you skip the above steps 3 and 4, playback starts from the first track of the group you selected in step 2.
- If you leave the unit for more than 30 seconds during operation, the Group search mode will be cancelled and the display returns to the normal one.