

JVC VIDEO CASSETTE RECORDER HR-S3901/3911U



INSTRUCTIONS

LPT0637-001A

CONTENTS

Buttons, Connectors and Indicators	4
Connections and Plug&Play Setting	5
Initial Settings	6
Language Setting	6
Clock Setting	6
Tuner Setting	7
Cable Box and/or DBS Receiver Control Setting	7
Basic Playback	9
Playback	9
Playback Features	9
Recording	11
Basic Recording	11
Recording Features	11
Timer Recording	12
Changing VCR Plus+® Setting	12
VCR Plus+® Timer Programming	12
Express Timer Programming	13
24HR Quick Programming	13
Other Functions	14
Timer warning display	14
Checking tape position	14
Changing display information	14
Function settings	14
Satellite Auto Recording	16
Child Lock	16
Multi-Brand Remote Control	17
Changing Remote Control Code	17
Editing	18
Specifications	19
Troubleshooting	20
FOR SERVICING (Only in U.S.A.)	21
WARRANTY (Only in U.S.A.)	22

Dear Customer,

Thank you for purchasing the JVC S-VHS video cassette recorder. Before use, please read the safety information and precautions to ensure safe use of your new VCR.

CAUTIONS

CAUTION
RISK OF ELECTRIC SHOCK
DO NOT OPEN

CAUTION: TO REDUCE THE RISK OF ELECTRIC SHOCK, DO NOT REMOVE COVER (OR BACK). NO USER-SERVICEABLE PARTS INSIDE. REFER SERVICING TO QUALIFIED SERVICE PERSONNEL.



The lightning flash with arrowhead symbol, within an equilateral triangle, is intended to alert the user to the presence of uninsulated "dangerous voltage" within the product's enclosure that may be of sufficient magnitude to constitute a risk of electric shock to persons.



The exclamation point within an equilateral triangle is intended to alert the user to the presence of important operating and maintenance (servicing) instructions in the literature accompanying the appliance.

WARNING:
TO PREVENT FIRE OR SHOCK HAZARD, DO NOT EXPOSE THIS UNIT TO RAIN OR MOISTURE.

CAUTION:
This video cassette recorder should be used with AC 120V~, 60Hz only.
To prevent electric shocks and fire hazards, DO NOT use any other power source.

CAUTION:
TO PREVENT ELECTRIC SHOCK, MATCH WIDE BLADE OF PLUG TO WIDE SLOT, FULLY INSERT.

ATTENTION:
POUR ÉVITER LES CHOCS ÉLECTRIQUES, INTRODUIRE LA LAME LA PLUS LARGE DE LA FICHE DANS LA BORNE CORRESPONDANTE DE LA PRISE ET POUSSER JUSQU'AU FOND.

Note to CATV system installer:

This reminder is provided to call the CATV system installer's attention to Article 820-40 of the NEC that provides guidelines for proper grounding and, in particular, specifies that the cable ground shall be connected to the grounding system of the building, as close to the point of cable entry as practical.

CAUTION:

Changes or modifications not approved by JVC could void user's authority to operate the equipment.

Declaration of Conformity

Model Number: HR-S3901/3911U
 Trade Name: JVC
 Responsible Party: JVC Americas Corp.
 Address: 1700 Valley Road Wayne, N.J. 07470
 Telephone Number: 973-317-5000

This device complies with Part 15 of FCC Rules.
 Operation is subject to the following two conditions:
 (1) This device may not cause harmful interference, and (2) this device must accept any interference received, including interference that may cause undesired operation.

Failure to heed the following precautions may result in damage to the VCR, Remote or video cassette.

1. **DO NOT** place the VCR . . .
 - ...in an environment prone to extreme temperatures or humidity.
 - ...in direct sunlight.
 - ...in a dusty environment.
 - ...in an environment where strong magnetic fields are generated.
 - ...on a surface that is unstable or subject to vibration.
2. **DO NOT** block the VCR's ventilation openings.
3. **DO NOT** place heavy objects on the VCR or on the Remote.
4. **DO NOT** place anything which might spill on the top of the VCR or on the Remote.
5. **AVOID** violent shocks to the VCR during transport.

VCR Plus+, C³ and PlusCode are registered trademarks of Gemstar Development Corporation.
 The VCR Plus+ system is manufactured under license from Gemstar Development Corporation.

For Customer Use:

Enter below the Model No. and Serial No. which are located on the rear of cabinet. Retain this information for future reference.

Model No. _____

Serial No. _____



- Cassettes marked "S-VHS" and "VHS" can be used with this video cassette recorder. However, S-VHS recordings are possible only with cassettes marked "S-VHS".
 By using S-VHS ET it is possible to record and play back with S-VHS picture quality on VHS cassettes with this VCR.
- As an ENERGY STAR® Partner, JVC has determined that this product or product model meets the ENERGY STAR® guidelines for energy efficiency.

IMPORTANT PRODUCT SAFETY INSTRUCTIONS

Electrical energy can perform many useful functions. But improper use can result in potential electrical shock or fire hazards. This product has been engineered and manufactured to assure your personal safety. In order not to defeat the built-in safeguards, observe the following basic rules for its installation, use and servicing.

ATTENTION:

Follow and obey all warnings and instructions marked on your product and its operating instructions. For your safety, please read all the safety and operating instructions before you operate this product and keep this booklet for future reference.

INSTALLATION**1. Grounding or Polarization**

(A) Your product may be equipped with a polarized alternating-current line plug (a plug having one blade wider than the other). This plug will fit into the power outlet only one way. This is a safety feature.

If you are unable to insert the plug fully into the outlet, try reversing the plug. If the plug should still fail to fit, contact your electrician to replace your obsolete outlet. Do not defeat the safety purpose of the polarized plug.

(B) Your product may be equipped with a 3-wire grounding-type plug, a plug having a third (grounding) pin. This plug will only fit into a grounding-type power outlet. This is a safety feature. If you are unable to insert the plug into the outlet, contact your electrician to replace your obsolete outlet. Do not defeat the safety purpose of the grounding-type plug.

2. Power Sources

Operate your product only from the type of power source indicated on the marking label. If you are not sure of the type of power supply to your home, consult your product dealer or local power company. If your product is intended to operate from battery power, or other sources, refer to the operating instructions.

3. Overloading

Do not overload wall outlets, extension cords, or integral convenience receptacles as this can result in a risk of fire or electric shock.

4. Power Cord Protection

Power supply cords should be routed so that they are not likely to be walked on or pinched by items placed upon or against them, paying particular attention to cords at plugs, convenience receptacles, and the point where they exit from the product.

5. Ventilation

Slots and openings in the cabinet are provided for ventilation. To ensure reliable operation of the product and to protect it from overheating, these openings must not be blocked or covered.

- Do not block the openings by placing the product on a bed, sofa, rug or other similar surface.
- Do not place the product in a built-in installation such as a bookcase or rack unless proper ventilation is provided or the manufacturer's instructions have been adhered to.

6. Wall or Ceiling Mounting

The product should be mounted to a wall or ceiling only as recommended by the manufacturer.

ANTENNA INSTALLATION INSTRUCTIONS**1. Outdoor Antenna Grounding**

If an outside antenna or cable system is connected to the product, be sure the antenna or cable system is grounded so as to provide some protection against voltage surges and built-up static charges. Article 810 of the National Electrical Code, ANSI/NFPA 70, provides information with regard to proper grounding of the mast and supporting structure, grounding of the lead-in wire to an antenna discharge unit, size of grounding connectors, location of antenna discharge unit, connection to grounding electrodes, and requirements for the grounding electrode.

2. Lightning

For added protection for this product during a lightning storm, or when it is left unattended and unused for long periods of time, unplug it from the wall outlet and disconnect the antenna or cable system. This will prevent damage to the product due to lightning and power-line surges.

3. Power Lines

An outside antenna system should not be located in the vicinity of overhead power lines or other electric light or power circuits, or where it can fall into such power lines or circuits. When installing an outside antenna system, extreme care should be taken to keep from touching such power lines or circuits as contact with them might be fatal.

EXAMPLE OF ANTENNA GROUNDING AS PER NATIONAL ELECTRICAL CODE, ANS/NFPA 70

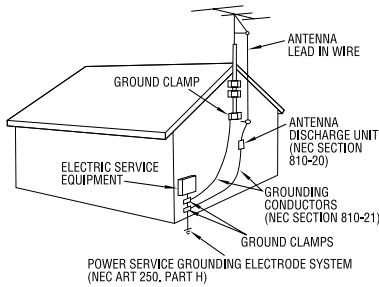

NEC – NATIONAL ELECTRICAL CODE

USE

1. Accessories

To avoid personal injury:

- Do not place this product on an unstable cart, stand, tripod, bracket, or table. It may fall, causing serious injury to a child or adult, and serious damage to the product.
- Use only with a cart, stand, tripod, bracket, or table recommended by the manufacturer or sold with the product.
- Use a mounting accessory recommended by the manufacturer and follow the manufacturer's instructions for any mounting of the product.
- Do not try to roll a cart with small casters across thresholds or deep-pile carpets.

2. Product and Cart Combination

A product and cart combination should be moved with care. Quick stops, excessive force, and uneven surfaces may cause the product and cart combination to overturn.

3. Water and Moisture

Do not use this product near water—for example, near a bath tub, wash bowl, kitchen sink or laundry tub, in a wet basement, or near a swimming pool and the like.

4. Object and Liquid Entry

Never push objects of any kind into this product through openings as they may touch dangerous voltage points or short-out parts that could result in a fire or electric shock. Never spill liquid of any kind on the product.

5. Attachments

Do not use attachments not recommended by the manufacturer of this product as they may cause hazards.

6. Cleaning

Unplug this product from the wall outlet before cleaning. Do not use liquid cleaners or aerosol cleaners. Use a damp cloth for cleaning.

7. Heat

The product should be situated away from heat sources such as radiators, heat registers, stoves, or other products (including amplifiers) that produce heat.

PORTABLE CART WARNING
(Symbol provided by RETAC)



SERVICING

1. Servicing

If your product is not operating correctly or exhibits a marked change in performance and you are unable to restore normal operation by following the detailed procedure in its operating instructions, do not attempt to service it yourself as opening or removing covers may expose you to dangerous voltage or other hazards. Refer all servicing to qualified service personnel.

2. Damage Requiring Service

Unplug this product from the wall outlet and refer servicing to qualified service personnel under the following conditions:

- a. When the power supply cord or plug is damaged.
- b. If liquid has been spilled, or objects have fallen into the product.
- c. If the product has been exposed to rain or water.
- d. If the product does not operate normally by following the operating instructions. Adjust only those controls that are covered by the operating instructions as an improper adjustment of other controls may result in damage and will often require extensive work by a qualified technician to restore the product to its normal operation.
- e. If the product has been dropped or damaged in any way.
- f. When the product exhibits a distinct change in performance—this indicates a need for service.

3. Replacement Parts

When replacement parts are required, be sure the service technician has used replacement parts specified by the manufacturer or which have the same characteristics as the original part. Unauthorized substitutions may result in fire, electric shock or other hazards.

4. Safety Check

Upon completion of any service or repairs to this product, ask the service technician to perform safety checks to determine that the product is in safe operating condition.

How to use the Remote

Before use, insert two AA size batteries into the Remote with the polarity (⊕ and ⊖) matched correctly as indicated on the battery compartment or on the lid.

The Remote can operate most of your VCR's functions, as well as basic functions of TV sets, cable boxes and DBS receivers.

- Point the Remote toward the remote sensor on the target component.
- The maximum operating distance of the Remote is about 8 m.

NOTE:

If the Remote does not work properly, remove its batteries, wait for a few seconds, replace the batteries and then try again.

Video heads cleaning

The heads get dirty in the following cases:

- in an environment prone to extreme temperature or humidity.
- in a dusty environment
- flaw, dirt or mold on video tapes
- continuous usage for a long time

Use a dry cleaning cassette — TCL-2 — when:

- Rough, poor picture appears while a tape is played back.
- The picture is unclear or no picture appears.
- "USE CLEANING CASSETTE" appears on the screen (only with "SUPERIMPOSE" set to "ON" (ⓘ pg. 15)).

ATTENTION:

To mobile phone users:

Using a mobile phone in the vicinity of the VCR may cause picture vibration on the TV screen or change the screen to a blue back display.

On placing the recorder:

Some TVs or other appliances generates strong magnetic fields. Do not place such appliance on top of the VCR as it may cause picture disturbance.

Buttons, Connectors and Indicators

Front Panel

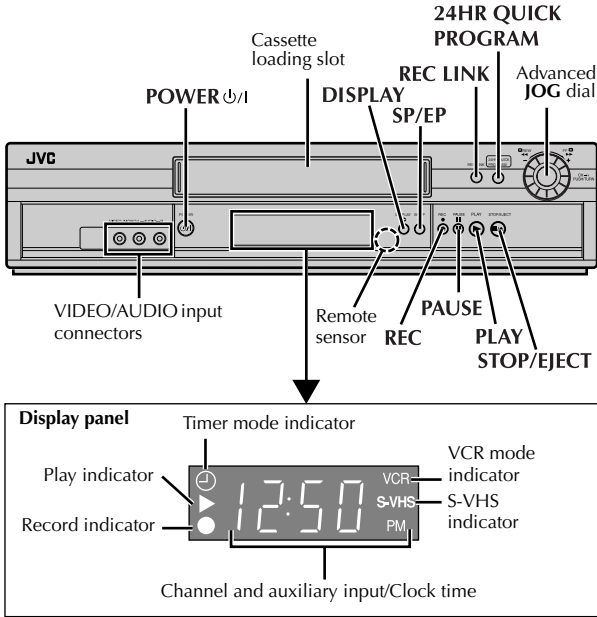

Rear Panel

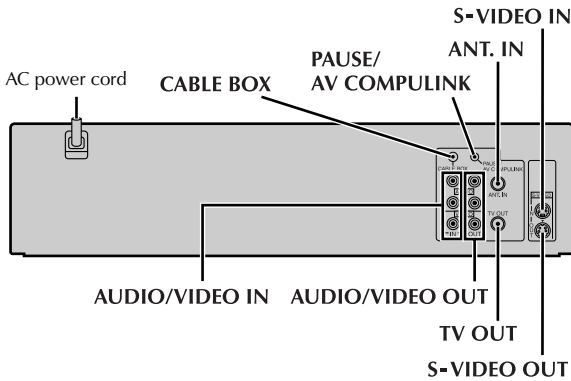

Remote

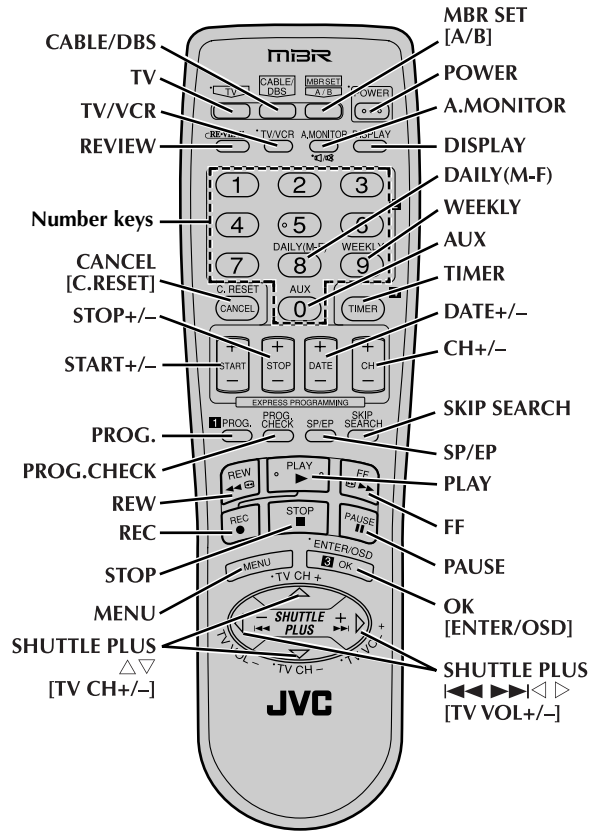

On-screen display

If you press **OSD (OK)** on the Remote when "SUPERIMPOSE" is set to "ON" (pg. 15), you can see the current VCR status on the TV screen.

The indications are not recorded even if the VCR is in the recording mode.

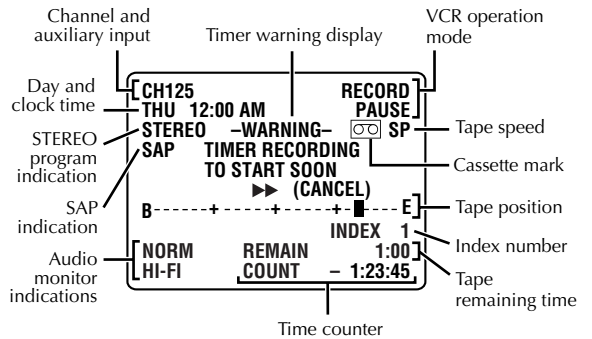

To recall an indication

- Press **OSD (OK)**.
 - All indications corresponding to the current status are displayed for 5 seconds. After that, the counter information and RECORD/PAUSE if in the Record Pause mode, are left displayed on the screen.
- Press **OSD (OK)** again to clear the display.
 - The RECORD/PAUSE indication is left displayed on the screen.

Connections and Plug&Play Setting

1 Check contents

Make sure the package contains all of the accessories listed in "Specifications" (☞ pg. 19).

2 Situate VCR

Place the VCR on a stable, horizontal surface.

3 Connect VCR to TV

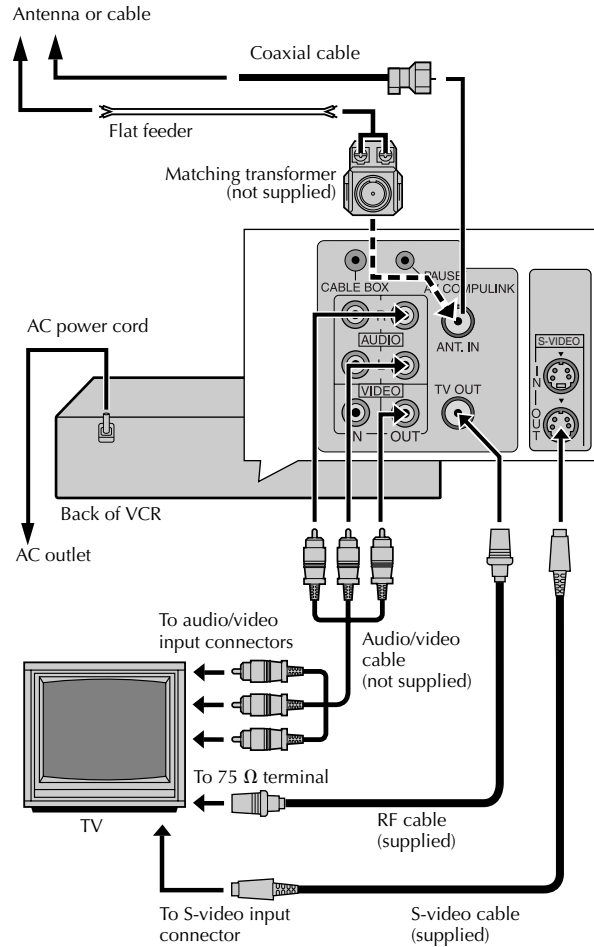

RF Connection

- 1 Disconnect the TV antenna from the TV.
- 2 Connect the TV antenna cable to the ANT. IN terminal on the rear of the VCR.
- 3 Connect the supplied RF cable between the TV OUT terminal on the rear of the VCR and the TV's antenna input terminal.

AV Connection

(improves picture quality during tape playback.)

If your TV is equipped with audio/video input connectors

- 1 Connect the antenna, VCR and TV as shown in the illustration.
- 2 Connect an audio/video cable between the AUDIO/VIDEO OUT connectors on the rear of the VCR and the audio/video input connectors on the TV.

S-video Connection

(allows you to make the most of the S-VHS picture performance.)

If your TV is equipped with a S-video input connector

- 1 Perform "RF Connection" above.
 - 2 Connect a S-video cable between the S VIDEO OUT connector on the rear of the VCR and the S-video input connector on the TV.
 - 3 Connect an audio cable between the AUDIO OUT connectors on the rear of the VCR and the audio input connectors on the TV.
- Even if you are using audio/video cables to connect your VCR to your TV, you must also connect it using the RF cable. This will ensure that you can record one show while watching another.

4 Perform Plug&Play setup

Plug the AC power cord into an AC outlet. Do not turn on the VCR. The clock and tuner channels will be set automatically. The time and date can be set automatically by the clock setting data transmitted from one of the regular TV broadcast channels. We call this TV channel the "host channel" and it is a PBS channel in your area.

ATTENTION:

If you use a cable box, Plug&Play will not function; set the clock and tuner channels separately (☞ pg. 6 – 7).

- Depending on areas or reception conditions, the VCR may not receive the Auto clock setting data from PBS channel. If this function is taking a considerable amount of time it may be necessary to perform the semiauto or manual clock set procedure.



During Initial Auto Clock Set
"Aut" blinks.



During Auto Channel Set

The channel numbers are displayed as they are scanned and set.



Plug&Play Completed

The current time is displayed.

What to do if Plug&Play setting failed

- If an incorrect time is displayed on the display panel, perform the procedure in "Semiauto Clock Set" (☞ pg. 6) or "Manual Clock Set" (☞ pg. 6).
- If "–:–" appears on the display panel, ensure that the antenna cable is connected correctly. Then turn on and off the VCR; the Plug&Play setting will be automatically reactivated. If Plug&Play setting is not performed though the antenna cable is connected correctly, perform the procedure in "Manual Clock Set" (☞ pg. 6) and "Auto Channel Set" (☞ pg. 7) or "Manual Channel Set" (☞ pg. 7).

5 Set VCR channel

The VCR channel is the channel on which you can watch the picture from the VCR on the TV when only using the RF connection. Press **POWER** to turn off the VCR, then press **STOP/EJECT** (■/▲) on the VCR for more than 5 seconds. "CH3" appears on the display panel. Press **CH+/-** on the Remote to select "CH3", "CH4" or "CH-"/(OFF), then press **OK**.

- The VCR channel is preset to "CH3". Set to "CH4" if CH3 is used for broadcasting in your area.

6 Final preparation for use

Turn on the VCR and the TV, and select the VCR channel 3 or 4 (or AV mode) on the TV. You can now perform basic playback or basic recording.

- If you connect the TV and the VCR only using the RF connection, press **TV/VCR** on the Remote so that the VCR mode indicator lights on the display panel.

Initial Settings

Language Setting

The default setting is "ENGLISH".

1 Access Main Menu screen, then Initial Set screen

Press **MENU** on the Remote. Press $\Delta \nabla$ to move the highlight bar (arrow) to "INITIAL SET", then press **OK** or \triangleright .

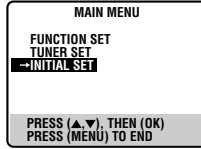

2 Select language

This VCR offers you the language choice to view menus and some messages — in English, Spanish or French. Press $\Delta \nabla$ to move the highlight bar (arrow) to "LANGUAGE", then press **OK** or \triangleright repeatedly until the desired language is selected. Press **MENU** to return to normal screen.

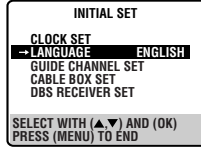

Language selection will be reset to "ENGLISH" after a power failure occurs.

Clock Setting

Perform clock setting only if the clock has not been set correctly by the Plug&Play setting or if you use a cable box.

Preparations

1 Access Main Menu screen, then Initial Set screen

Press **MENU** on the Remote. Press $\Delta \nabla$ to move the highlight bar (arrow) to "INITIAL SET", then press **OK** or \triangleright .

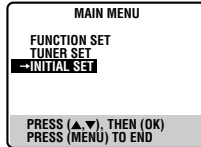

2 Access Clock Set screen

Press $\Delta \nabla$ to move the highlight bar (arrow) to "CLOCK SET", then press **OK** or \triangleright .

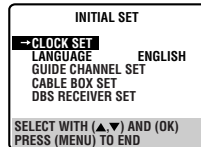

Setting clock semiautomatically — Semiauto Clock Set

You can change the host channel/D.S.T. (Daylight Saving Time)/time zone setting manually. First follow steps **1** to **2** in "Preparations" above, then go to the following steps.

NOTE:

The time set previously will be erased when "AUTO CLOCK", "HOST CH", "D.S.T." or "TIME ZONE" setting is changed.

1 Set Auto Clock to ON

Press **OK** or \triangleright on the Remote repeatedly to move the highlight bar to "AUTO CLOCK", then press $\Delta \nabla$ so that "ON" is selected.

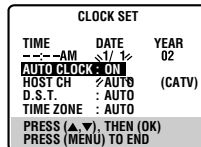

2 Select host channel

You can either select "AUTO" or enter a PBS channel number. Press **OK** or \triangleright to move the highlight bar to "HOST CH", then press $\Delta \nabla$ repeatedly until "AUTO" or the desired PBS channel number is selected.

- Some PBS channels do not transmit clock setting data.

3 Select D.S.T. mode

Press **OK** or \triangleright to move the highlight bar to "D.S.T.", then press $\Delta \nabla$ repeatedly until the desired setting is selected.

AUTO: Select if you want to adjust your VCR's clock automatically by the incoming signal from the host channel. (Auto Daylight Saving Time enables automatic adjustment of the VCR's clock at the start and end of Daylight Saving Time.) Be sure to select the correct time zone manually in step **4**.

ON: Adjustment will be made by the built-in clock itself.

OFF: Select when Daylight Saving Time does not apply to you.

4 Select time zone

Press **OK** or \triangleright to move the highlight bar to "TIME ZONE", then press $\Delta \nabla$ repeatedly until "AUTO" or the desired time zone is selected. Each time you press the button, the time zone changes as follows:

- ↔ AUTO ↔ ATLANTIC ↔ EASTERN ↔ CENTRAL
- ↔ MOUNTAIN ↔ PACIFIC ↔ ALASKA ↔ HAWAII
- ↔ (back to the beginning)

5 Complete Semiauto Clock Set

Press **MENU** to return to normal screen. Turn off the VCR. "Aut" will appear on the display panel while the clock is being set. The current clock time will appear automatically when the clock setting is complete.

Selections of host channel and D.S.T. mode will be reset to "AUTO" after a power failure occurs.

Setting clock manually — Manual Clock Set

First follow steps **1** to **2** in "Preparations" above, then go to the following steps.

1 Set time, date and year

Press $\Delta \nabla$ until the desired time appears, then press **OK** or \triangleright . Set the date and year in the same way.

- Holding $\Delta \nabla$ changes the time in 30-minute intervals, or changes the date in 15-day intervals.

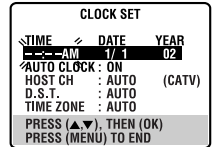

2 Select D.S.T. mode

Press **OK** or \triangleright to move the highlight bar to "D.S.T.", then press $\Delta \nabla$ to select the desired setting.

ON: Adjustment will be made by the built-in clock itself.

OFF: Select when Daylight Saving Time does not apply to you.

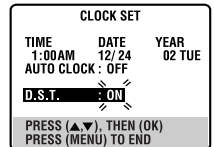

3 Start clock

Press **MENU** and normal screen appears.

To make corrections any time during the process

Press **OK** or \triangleright repeatedly until the item you want to change blinks, then press $\Delta \nabla$.

Manual setting of the clock will be lost after a power failure occurs.

Tuner Setting

Setting channels automatically

— Auto Channel Set

Perform Auto Channel Set only if channels have not been set correctly by the Plug&Play setting.

1 Access Main Menu screen, then Tuner Set screen

Press **MENU** on the Remote. Press $\Delta \nabla$ to move the highlight bar (arrow) to "TUNER SET", then press **OK** or \triangleright .

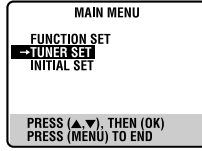

2 Perform Auto Channel Set

Press $\Delta \nabla$ to move the highlight bar (arrow) to "AUTO CHANNEL SET", then press **OK** or \triangleright . The VCR selects the correct band (TV or CATV) automatically during Auto Channel Set.

- When Auto Channel Set is complete, "SCAN COMPLETED" appears on screen.
 - If the scan was unsuccessful, "SCAN COMPLETED—NO SIGNAL—" appears on screen. Check the connections and start again.
- Press **MENU** to return to normal screen.

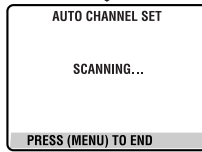
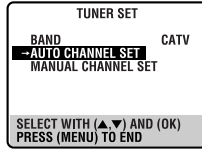

Setting channels manually

— Manual Channel Set

You can add the channels you want or delete the channels you do not want manually.

1 Access Main Menu screen, then Tuner Set screen

Press **MENU** on the Remote. Press $\Delta \nabla$ to move the highlight bar (arrow) to "TUNER SET", then press **OK** or \triangleright .

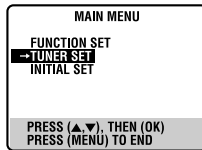

2 Access Manual Channel Set screen

Press $\Delta \nabla$ to move the highlight bar (arrow) to "MANUAL CHANNEL SET", then press **OK** or \triangleright .

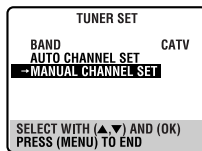

3 Add or skip desired channels

To add channels

- 1 Press the **Number** keys on the Remote to input a channel number you want to add.
- 2 Press **OK** or \triangleright to set to "ADD".
- 3 Repeat **1** to **2** to add other channels. Press **MENU** to return to normal screen.

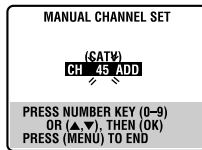

To skip channels

- 1 Press $\Delta \nabla$ or the **Number** keys to select a channel number you want to skip.
- 2 Press **OK** or \triangleright to set to "SKIP".
- 3 Repeat **1** and **2** to skip other channels. Press **MENU** to return to normal screen.

After a power failure occurs...
 • Band selection will be reset to "CATV".

Cable Box and/or DBS Receiver Control Setting

The following procedure is required if you receive your TV channels through a cable box (descrambler) and/or if you receive satellite channels through DBS (Direct Broadcast Satellite) receiver. The Controller allows the VCR to automatically switch the cable box or DBS receiver's channel during timer recording.

NOTES:

- The Controller is not supplied with this unit. It can be requested by mailing in the completed JVC Cable Mouse Certificate that is included with the accessory package.
- For the cable box, the Controller is effective for VCR Plus+ or Express timer programming.
- For the DBS receiver, the Controller is effective only for Express timer programming.
- When connecting your cable box or DBS receiver, refer to its instruction manual.

1 Situate Controller

If both a cable box and a DBS receiver are used, position the Controller so its signal reaches the remote sensors on both the cable box and DBS receiver.

2 Attach Controller

Fix securely using the adhesive strip attached on the back of the Controller.

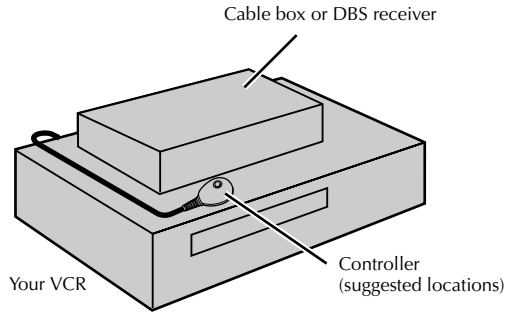

3 Connect cable box and/or DBS receiver to VCR

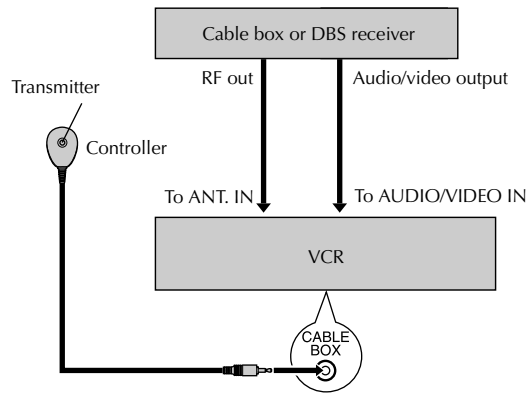

- If your cable box or DBS receiver does not have audio/video output connectors, connect the RF output terminal on the unit to the ANT. IN terminal on the rear of your VCR.
- If your cable box or DBS receiver has audio/video output connectors, connect an audio/video cable between the AUDIO/VIDEO IN connectors on the rear of the VCR and the audio/video output connectors on the unit.
- If both a cable box and a DBS receiver are used, it is recommended that you connect the DBS receiver to your VCR's AUDIO/VIDEO IN connectors and the cable box to your VCR's ANT. IN connector.

4 Connect Controller to VCR

Connect the Controller to the CABLE BOX Controller connector on the rear panel.

5 Turn on cable box or DBS receiver

Select a channel other than channel 9 on your cable box, or channels 100, 205 on your DBS receiver.

6 Access Main Menu screen, then Initial Set screen on VCR

Press **MENU** on the Remote. Press \triangle/∇ to move the highlight bar (arrow) to "INITIAL SET", then press **OK** or \triangleright .

7 Access Cable Box Set screen or DBS Receiver Set screen

Press \triangle/∇ to move the highlight bar (arrow) to "CABLE BOX SET" or "DBS RECEIVER SET", then press **OK** or \triangleright .

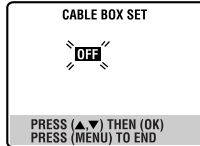
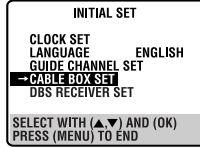

8 Select output channel

Your selection depends on how the unit is connected to your VCR.

- **If the unit is connected to your VCR's ANT. IN terminal on the rear panel,** Press \triangle/∇ until the channel number representing the cable box's output (CH2 – CH9) or DBS receiver's output (CH3 or CH4) appears on the screen.
- **If the unit is connected to your VCR's AUDIO/VIDEO IN connectors on the front panel,** press \triangle/∇ until "ON F-1 (FRONT)" appears on the screen.
- **If the unit is connected to your VCR's AUDIO/VIDEO IN connectors on the rear panel,** press \triangle/∇ until "ON L-1 (REAR)" appears on the screen.
- **If you do not use any unit,** press \triangle/∇ until "OFF" appears on the screen.

9 Access Brand Set screen

Press **OK** or \triangleright .

- If the Clock Set screen appears, perform "Manual Clock Set". If you press **MENU** after the clock has been set, the Brand Set screen appears.

10 Enter brand code and perform test

Press the appropriate **Number keys** on the Remote to enter the brand code from the following list, then press **OK** or \triangleright .

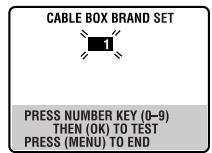

CABLE BOX BRAND	CODE
ARCHER	1, 5, 17
CABLETENNA	1, 17
CABLEVIEW	15, 16, 17, 21, 25
CITIZEN	15, 16, 17, 21, 25
CURTIS	2, 8
DIAMOND	1, 17
GC BRAND	15, 16, 17, 21, 25
GEMINI	15
GENERAL INSTRUMENTS	1, 4, 6, 11, 12, 15, 28
HAMLIN	10, 18, 23
JASCO	15
JERROLD	1, 4, 6, 11, 12, 15, 28
NOVAVISION	2, 8
OAK	7, 20
PANASONIC	13, 14
PULSER	15, 16, 17, 21, 25
RCA	13, 14
REGAL	10, 18, 23
REMBRANDT	1, 16, 17
SAMSUNG	5, 16, 24
SCIENTIFIC ATLANTA	2, 8
SIGMA	7, 20
SL MARX	5, 16, 17, 24, 25
SPRUCER	13, 14
STARGATE	5, 15, 16, 17, 21, 24, 25
TELEVIEW	5, 16, 24
TOCOM	1, 4, 16
UNIKA	1, 17
UNIVERSAL	16, 17, 25
VIDEOWAY	3, 9, 22
ZENITH	3, 9, 22

DBS RECEIVER BRAND	CODE	DBS RECEIVER BRAND	CODE
JVC (DISH Network)	51	SONY (DSS)	41
ECHOSTAR (DISH Network)	51	RCA (DSS)	40

For cable box

- **If the cable box's channel changes to 9,** setting is complete. Press **OK**.
- **If the cable box's channel does not change to 9;**
 - 1 Press \triangle/∇ to move the highlight bar (arrow) to "NO", then press **OK** or \triangleright .
 - 2 Repeat step 10 until the cable box's channel changes to 9 by entering another code.
 - 3 If the channel does not change after going through all the code numbers listed for your model of cable box, then try all the other numbers.

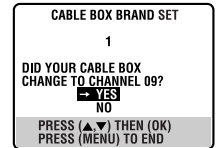

For DBS receiver

- **If the DBS receiver's channel changes to the channel listed below for your brand,** setting is complete. Press **OK** or \triangleright .

JVC	→ 100	SONY	→ 205
ECHOSTAR	→ 100	RCA	→ 205
- **If the DBS receiver's channel does not change as shown above;**
 - 1 Press \triangle/∇ to move the highlight bar (arrow) to "NO", then press **OK** or \triangleright .
 - 2 Repeat step 10.

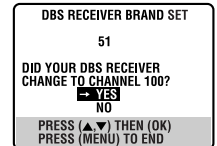

Playback

Basic Playback

1 Load a cassette

Make sure the window side is up, the rear label side is facing you and the arrow on the front of the cassette is pointing towards the VCR.

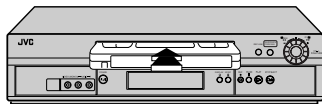

- Do not apply too much pressure when inserting.
- The VCR turns on, and the counter on the on-screen display is reset, automatically.
- If the cassette's record safety tab has been removed, playback begins automatically.

2 Start playback

Press **PLAY** (▶).

- The S-VHS indicator lights up when you play back a tape recorded in S-VHS mode or in S-VHS ET mode (Ⓢ pg. 11).

During playback

Stop playback

Press **STOP** (■) on the Remote. **OR** Press **STOP/EJECT** (■/▲) on the VCR.

Pause playback and view still picture

Press **PAUSE** (||). **OR** Push the **JOG** dial.
 • Press **PLAY** (▶) to resume normal playback. **OR** Push the **JOG** dial again to resume normal playback.

NOTE:

*During still picture, vertical vibration may appear on the TV screen. Press **CH+/-** on the remote to get a clearer picture.*

Pause and Frame-by-Frame playback

Press **PAUSE** (||) to pause, then press **◀◀** or **▶▶** (or **PAUSE** (||) repeatedly). **OR** Push the **JOG** dial to pause, then turn the **JOG** dial to the left or right.
 • Press **PLAY** (▶) to resume normal playback. **OR** Push the **JOG** dial again to resume normal playback.

High-Speed Picture Search

Press **REW** (◀◀) or **FF** (▶▶). **OR** Turn the **JOG** dial quickly to the left or right.
 • Press **PLAY** (▶) to resume normal playback.
 • If you press and hold **REW** (◀◀) or **FF** (▶▶) for more than 2 seconds, simply releasing it cancels the picture search, and normal playback resumes.

Variable-Speed Picture Search (including slow-motion)

Press **◀◀** or **▶▶** repeatedly. **OR** Turn the **JOG** dial to the left or right.
 • Press **PLAY** (▶) to resume normal playback.
 • Each time you press **◀◀** or **▶▶** or each time **JOG** dial passes a click position, the playback speed changes. To decrease the speed during picture search, press the opposite direction button repeatedly or turn the dial in the opposite direction.
 • During still picture, press and hold **▶▶** to start forward (or **◀◀** to start reverse) slow motion playback. When you release the button, still picture resumes. During still picture, holding **PAUSE** (||) for more than 2 seconds also starts forward slow motion playback. If you press **PAUSE** (||) again, still picture resumes.

NOTE:

*During slow motion, some noise may appear on the TV screen. Press **CH+/-** on the remote to eliminate the noise.*

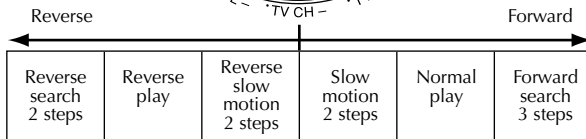
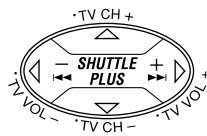

When the tape is not running

Rewind/fast-forward

Press **REW** (◀◀) or **FF** (▶▶). **OR** Turn the **JOG** dial to the left or right.

Eject the cassette

Press **STOP/EJECT** (■/▲).

- You can also eject the cassette when the VCR is turned off.

Turn off the VCR

Press **POWER** ⏻.

Playback Features

Adjusting tracking condition

— Tracking Adjustment

Automatic tracking adjustment

Whenever you insert a tape and start playback, automatic tracking starts working and continuously analyzes the signal to enable optimum picture quality during playback.

Manual tracking adjustment

If automatic tracking cannot eliminate noises well during playback, follow the procedures below.

On the Remote

- 1 Press **SP/EP** during playback to activate manual tracking.
- 2 Press **CH +/-** to eliminate the noises. Press it briefly for a fine adjustment, or press and hold for a coarse adjustment.
 - Press **SP/EP** again to reactivate automatic tracking.

Selecting monitor sound

— Audio Monitor

While playing back a tape on which stereo sound or SAP sound is recorded, press **A.MONITOR** on the Remote. Each time you press the button, sound changes.

HI-FI: Normally select this. Hi-Fi sound is played back.

HI-FI L: Sound on the left Hi-Fi channel is played back.

HI-FI R: Sound on the right Hi-Fi channel is played back.

NORM: Sound on the normal track is played back.

NORM HI-FI: Both sounds on the Hi-Fi track and normal track are mixed and played back.

NOTE:

The above indication appears when "SUPERIMPOSE" is set to "ON", though the monitor sound changes in sequence.

Automatic operations after rewinding

— Next Function Memory

The Next Function Memory “tells” the VCR what to do after rewinding is complete. Ensure that the VCR is in stop mode.

- **For Automatic Playback Start**

Press **REW** (◀◀), then press **PLAY** (▶) within 2 seconds.

- **For Automatic Power Off**

Press **REW** (◀◀), then press **POWER** ⏻ within 2 seconds.

- **For Automatic Timer Standby**

Press **REW** (◀◀), then press **TIMER** within 2 seconds.

NOTE:

It is not possible to select the Automatic Timer Standby function if the cassette's record safety tab is removed.

Playing back tape repeatedly (100 times)

— Repeat Play

During playback, press and hold **PLAY** (▶) for more than 5 seconds. The play indicator (▷) on the display panel starts blinking slowly. To stop playback, press **STOP** (■) on the Remote or **STOP/EJECT** (■/▲) on the VCR.

Locating beginning of recordings

— Index Search

Index codes are placed on the tape at the beginning of each recording when recording on this VCR.

1 While the tape is not running, press **SHUTTLE PLUS** |◀◀ or ▶▶| on the Remote to start search.

2 To access a recording of 2 to 9 index codes away, press |◀◀ or ▶▶| repeatedly until the correct number is displayed on the screen (only if “SUPERIMPOSE” is set to “ON” (ⓘ pg. 15)). Playback begins automatically when the desired recording is located.

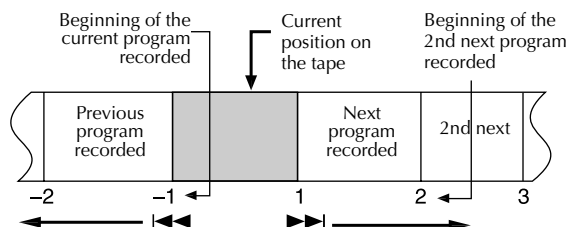

Locating beginning of timer recordings

— Instant Review

After ensuring that the VCR is turned off and that the timer mode is disengaged, press **REVIEW**.

- The VCR turns on, and rewinds to the index code indicating the beginning of the last timer-recorded program, then begins playback automatically.
- You can access a program of 2 to 9 index codes away from the current position on the tape. If, for example, you have 5 programs recorded and you want to watch the third one, press **REVIEW** three times.
- The Instant Review function will also operate if the VCR is turned on.

Skipping unwanted portions

— Skip Search

Press **SKIP SEARCH** on the Remote once to 4 times during playback. Each press initiates a 30-second period of high speed playback (up to 2 minutes). When the specified portion of the tape is skipped, normal playback resumes automatically. To return to normal playback during Skip Search, press **PLAY** (▶).

Recording

It may be unlawful to record or play back copyrighted material without the consent of the copyright owner.

Accidental erasure prevention

To prevent accidental recording on a recorded cassette, remove its record safety tab. To record on it later, cover the hole with adhesive tape.



Basic Recording

1 Load a cassette

Make sure the record safety tab is intact. If not, cover the hole with adhesive tape before inserting the cassette.

- The VCR turns on, and the counter on the on-screen display is reset, automatically.

2 Select recording channel

Press **CH+/-** or the **Number keys** on the Remote. Or push the **JOG** dial, then turn it to the left or right.

- If you connect the TV and the VCR only using the RF connection, press **TV/VCR** on the Remote so that the VCR mode indicator lights on the display panel, to view the program to be recorded.

3 Set tape speed

Press **SP/EP**. The selected tape speed will appear on the TV screen.

NOTE:

You can select tape speed in the stop mode or during recording pause mode.

4 Start recording

On the VCR, press **REC** (●). Or on the Remote, while holding **REC** (●), press **PLAY** (▶).

NOTE:

If "VIDEO CALIBRATION" is set to "ON" (☞ pg. 15) (default setting), the VCR takes about 7 seconds to assess the quality of the tape in use, then recording begins with the picture level optimized.

During recording

Pause recording

Press **PAUSE** (||).

- Press **PLAY** (▶) to resume recording.
- You can select channel in the recording pause mode.

Stop recording

Press **STOP** (■) on the Remote. **OR** Press **STOP/EJECT** (■/▲) on the VCR.

NOTE:

If the tape reaches its end during recording, the recording stops and "○" and "▷" on the display panel blink. Press **STOP/EJECT** (■/▲) on the VCR to eject the cassette or press **REW** (◀◀) on the Remote to rewind the tape.

Recording Features

Specifying recording length

— Instant Timer Recording (ITR)

During recording, press **REC** (●) on the VCR repeatedly until the recording length you want appears on the display panel. The record indicator (○) on the display panel starts blinking.

- Each time you press the button, recording length increases in 30-minute intervals (up to 6 hours).
- The VCR shuts off after recording is finished.
- To cancel an ITR, press **STOP** (■) on the Remote or **STOP/EJECT** (■/▲) on the VCR.

Watching one program while recording another

During recording...

- If you connect the TV and the VCR only using the RF connection (☞ pg. 5) to view pictures from the VCR, press **TV/VCR** on the Remote so that VCR mode indicator goes off from the display panel. (The TV broadcast being recorded disappears.)
- If you are using the AV connection (☞ pg. 5) to view pictures from the VCR, change the TV's input mode from AV to TV. Then, select the channel you want to watch, on the TV.

Second Audio Recording

This VCR's built-in MTS decoder enables reception of Multichannel TV Sound broadcast. To record a SAP program received, set "2ND AUDIO RECORD" to "ON" (☞ pg. 15).

S-VHS (Super VHS), S-VHS ET or VHS Recording Mode

This VCR can record in S-VHS (Super VHS), S-VHS ET or VHS.

• To record in S-VHS:

Set "S-VHS MODE" to "ON" (☞ pg. 16). Then, insert a cassette marked "S-VHS". The S-VHS indicator lights up on the display panel.

The S-VHS recording mode is selected.

• To record in S-VHS ET on a VHS cassette:

Set "S-VHS ET" to "ON" (☞ pg. 15). Then, insert a cassette marked "VHS". The S-VHS indicator lights up on the front display panel.

• To record in VHS:

Insert a cassette marked "VHS".

Set "S-VHS ET" to "OFF" (☞ pg. 15).

• To record in VHS on an S-VHS cassette:

Insert a cassette marked "S-VHS". The S-VHS indicator lights up on the display panel. Then, set "S-VHS MODE" to "OFF" (☞ pg. 16). The S-VHS indicator goes off.

The VHS recording mode is selected.

NOTE:

When playing back a tape that has been recorded in S-VHS or S-VHS ET, the S-VHS indicator lights up on the display panel regardless of the "S-VHS ET" or "S-VHS MODE" setting.

Timer Recording

Up to 8 timer recording programs can be made using VCR Plus+ timer programming, Express timer programming or 24HR Quick Programming method as far as a year in advance. Remember, the clock must be set before you can program the timer.

NOTES:

- If all the 8 programs have already been set, "PROGRAM FULL" or "Full" appears on the TV screen or the display panel.
- After timer recording is completed, the VCR turns off automatically.
- You can program the timer recording while a regular recording is in progress; the menu screens will not be recorded.
- To timer-record cable or satellite channels, perform "Cable Box and/or DBS Receiver Control Setting" and be sure to keep the cable box or DBS receiver turned on.
- Even if a power failure occurs, the VCR keeps your timer programs. However, the clock time, channel settings, and other menu settings are lost. As a result, when the power is supplied again to this VCR after the power failure, this VCR starts the Plug&Play setting automatically to restore the clock time and channel setting. If the clock time and channel setting are restored correctly, each timer program you have made will start at its start time unless its end time has elapsed.

NOTE:

If the tape reaches its end during timer recording, the recording stops and "⊕", "○" and "▷" on the display panel blink. Press **TIMER** to disengage timer, then press **STOP/EJECT** (■/▲) on the VCR to eject the cassette or press **POWER** (⏻) then press **REW** (◀) on the Remote to rewind the tape.

Changing VCR Plus+® Setting

The VCR Plus+ programming system assigns a VCR Plus+ guide channel to the TV channels and the cable channels. These guide channel numbers are also called the VCR Plus+ channel codes. Most TV listings have a section, usually a chart, indicating the guide channel numbers assigned to each station.

To ensure that VCR Plus+ timer recording operates correctly, it is necessary to set the VCR Plus+ "Guide Channel Set" for each station.

If you have moved to a different area or if a broadcasting station's channel number has been changed, perform the following steps to set the correct guide channel number.

1 Access Main Menu screen, then Initial Set screen

Press **MENU** on the Remote. Press Δ/∇ to move the highlight bar (arrow) to "INITIAL SET", then press **OK** or \triangleright .

2 Access Guide Channel Set screen

Press Δ/∇ to move the highlight bar (arrow) to "GUIDE CHANNEL SET", then press **OK** or \triangleright .

3 Input guide channel number

Press Δ/∇ or the **Number** keys to select the VCR Plus+ guide channel number as shown in the TV listing, then press **OK** or \triangleright .

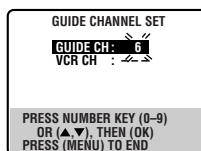

4 Input receiving channel number

Press Δ/∇ or the **Number** keys to select the number of the channel on which the guide channel's broadcasts are received, then press **OK** or \triangleright .

- Repeat steps **3** and **4** for each instance.



5 Return to normal screen

Press **MENU** on the Remote.

VCR Plus+® Timer Programming

The PlusCode programming numbers are the numbers next to the program in most TV listing.

Load a cassette with the record safety tab intact. The VCR turns on, and the counter is reset, automatically.

- 1 Press **PROG.** on the Remote to access the PlusCode No. screen.

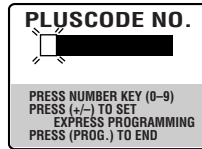

- 2 Press the appropriate **Number** keys to input the PlusCode number, then press **OK** or \triangleright . Check to make sure the setting is accurate on the Program screen.

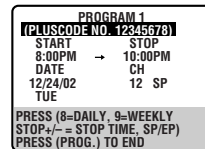
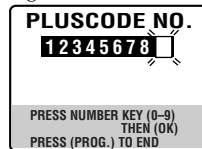

- If the Guide Channel Set screen appears after pressing **OK**, press the **Number** keys, **CH+/-** or Δ/∇ to input the number of the channel on which the broadcast for the PlusCode number is received on the VCR or cable box, then press **OK**.
 - To set the tape speed, press **SP/EP**.
 - To change the stop time, press **STOP+/-**.
 - To timer-record daily (Monday-Friday) or weekly serials, press **DAILY (M-F)** (Number key "8") or **WEEKLY** (Number key "9"). Pressing the button again makes the "DAILY" or "WEEKLY" display disappear.
 - If you made a mistake, press **CANCEL** to access the PlusCode No. screen again.
 - If an incorrect PlusCode number or the one for a broadcast already finished has been inputted, "ERROR" is displayed for about 5 seconds, then the PlusCode No. screen reappears.
- 3 Press **OK** or **PROG.**
 - If "PROGRAM NOT COMPLETED PROGRAM OVERLAP" appears, see "Program overlap warning display" (pg. 14).
 - 4 Press **TIMER**. The VCR turns off automatically and "⊕" is displayed on the display panel.

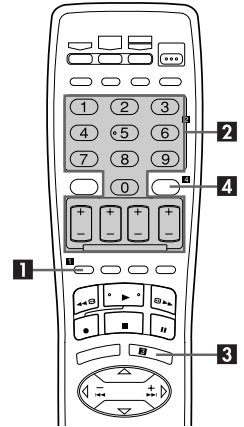
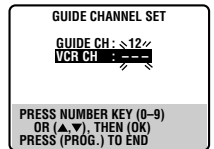

Express Timer Programming

Load a cassette with the record safety tab intact. The VCR turns on, and the counter is reset, automatically.

1 Press **PROG.** on the Remote to access the PlusCode No. screen.

2 Press **START+/-** once to access Program screen.

Press **START+/-**, **STOP+/-**, **DATE+/-** or **CH+/-** repeatedly to enter the start time, stop time, date or channel.

- Press and hold **START+/-** or **STOP+/-** to increase the time in 30-minute intervals.

- To set the tape speed, press **SP/EP**.

- To timer-record daily (Monday–Friday) or weekly serials, press **DAILY (M-F)** (Number key “8”) or **WEEKLY** (Number key “9”). Pressing the button again makes the “DAILY” or “WEEKLY” display disappear.

- If you are using a DBS receiver and “DBS RECEIVER SET” is set to “ON”, the band indication appears under the channel number indication. (Refer to “Cable Box and/or DBS Receiver Control Setting” (ⓘ pg. 7).)

TV: To timer-record a regular TV broadcast received on the VCR.

CATV: To timer-record a cable TV broadcast received on the VCR, or through a cable box (unless “CABLE BOX SET” is set to “OFF”).

DBS: To timer-record a satellite broadcast received through a DBS receiver.

If the channel number entered requires that the band be set and “7=DBS” is displayed on the screen, press **Number key “7”** to select “DBS”.

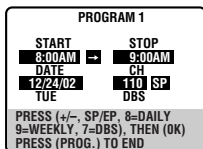
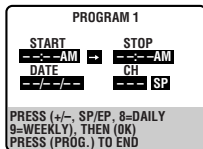

3 Press **OK** or **PROG.**

- If “PROGRAM NOT COMPLETED PROGRAM OVERLAP” appears, see “Program overlap warning display” (ⓘ pg. 14).

4 Press **TIMER**. The VCR turns off automatically and “⏻” is displayed on the display panel.

24HR Quick Programing

You can program a timer recording that starts within 24 hours using the JOG dial on the VCR.

Load a cassette with the record safety tab intact. The VCR turns on, and the counter is reset, automatically.

1 Press **24HR QUICK PROGRAM** on the VCR. “▷” starts blinking on the display panel.

2 Turn the **JOG** dial to the left or right to set the start time.

- One click stop of the JOG dial changes the time in 5-minute intervals.

3 Push the **JOG** dial. “○” starts blinking on the display panel. Turn the **JOG** dial to the left or right to set the stop time.

- To set the tape speed, press **SP/EP**. The current setting for the tape speed appears on the display panel for about 5 seconds. Press **SP/EP** again to change the setting while tape speed is displayed.

4 Push the **JOG** dial. Turn the **JOG** dial to the left or right to select the channel, then press **24HR QUICK PROGRAM**. The VCR turns off automatically and “⏻” is displayed on the display panel.



NOTES:

- If “Err” appears on the display panel, repeat the above steps again.
- When a menu screen is shown, you cannot use 24HR Quick Programing function. Press **MENU** to return to normal screen, and try again.
- You can use 24HR Quick Programing function also when the VCR is turned off.
- For 24HR Quick Programing function, the program overlap warning display does not appear even if some programs overlap each other.

To use the VCR while it is in timer recording standby mode

Press **TIMER**, then press **POWER** ⏻. After you use the VCR, press **TIMER** again to put the VCR into timer recording standby mode.

Checking, canceling or changing program settings

1 Disengage timer

Press **TIMER**, then press **POWER** ⏻.

- When “AUTO TIMER” is set to “ON” (ⓘ pg. 15), you do not have to press **TIMER**.

2 Access Program Check screen

Press **PROG. CHECK**.

3 Access Program screen

Press **PROG. CHECK** again. Each time you press **PROG. CHECK**, the next program’s Program screen appears.

PR	START	STOP	CH	DATE
1	8:00P	10:00	12	12/24
2	10:00A	10:45	40	12/25
3	11:30P	1:00	125	12/25
4				
5				
6				
7				
8				

PRESS (CHECK) TO NEXT

4 Cancel or change program setting

To cancel a program, press **CANCEL** when the Program screen you do not want is shown.

To change a program, press the appropriate button: **START+/-**, **STOP+/-**, **DATE+/-**, **CH+/-**, **DAILY (M-F)** (Number key “8”), **WEEKLY** (Number key “9”) and/or **SP/EP** when the Program screen on which you want to make changes is shown.

5 Return to normal screen

Press **PROG. CHECK** repeatedly until no Program screen is shown.

6 Reengage timer recording standby mode

Press **TIMER**. The VCR turns off automatically and “⏻” is displayed on the display panel.

- When “AUTO TIMER” is set to “ON” (ⓘ pg. 15), the timer recording standby mode automatically resumes when you turn off the VCR.

Program overlap warning display

If "PROGRAM NOT COMPLETED PROGRAM OVERLAP" appears, you have another program overlapping the program you have just made. The Program Check screen appears and conflicting programs will start blinking.

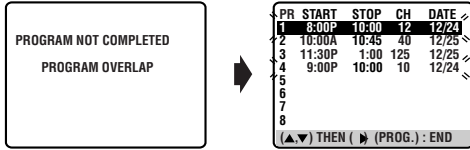

Example:

Program 1 (you have just made) and Program 4 overlap each other

1 Select program to modify

Press ▲▼, then press OK or ▶.

- You can only select one of the overlapping programs.
- If you do not mind this overlap, press **PROG.** to finish the timer program setting. The program starting earlier or program with the lower program number will be recorded.

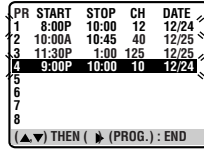

2 Cancel or change program setting

To cancel a program, press **CANCEL** when the Program screen you do not want is shown.

To change a program, press the appropriate button: **START+/-**, **STOP+/-**, **DATE+/-**, **CH+/-**, **DAILY (M-F)** (Number key "8"), **WEEKLY** (Number key "9") and/or **SP/EP** when the Program screen on which you want to make changes is shown, then press **OK** or ▶.

- If the overlap is not yet solved, the conflicting programs will be shown on the Program check screen. Repeat the above steps again.

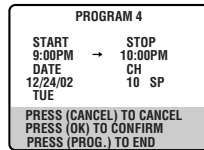

Other Functions

Timer warning display

A warning appears on the TV screen to tell you that the timer-recording is to start in 5 minutes if you are not in the timer recording standby mode at that time. Press **TIMER** to put the VCR into timer recording standby mode. To clear the display, press **CANCEL** on the Remote.



Checking tape position

When you change the VCR operation mode from the stop mode to fast forward or rewind mode, or when you perform an Index Search or Instant Review, the tape position indicator appears.

The position of "■" in relation to "B" (Beginning) or "E" (End) shows you where you are on the tape.

- Set "SUPERIMPOSE" to "ON" (☞ pg. 15).

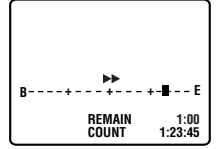

Changing display information

Each time you press **DISPLAY**, the display panel shows the channel number and the clock time alternatively.

- You can change display in the stop or recording mode, or during rewind/fast-forward.
- When "SUPERIMPOSE" is set to "ON" (☞ pg. 15) and **DISPLAY** on the Remote is pressed, time counter and tape remaining time will appear on the TV screen. To reset the time counter, press **C.RESET** on the Remote.



Function settings

You can use the other useful function settings on the Function Set screen.

1 Access Main Menu screen, then Function Set screen

Press **MENU** on the Remote. Press ▲▼ to move the highlight bar (arrow) to "FUNCTION SET", then press **OK** or ▶.

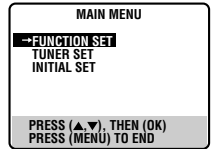

2 Select Function

Press ▲▼ to move the highlight bar (arrow) to the function you want to set.

FUNCTION	OFF	PREVIOUS PAGE	OFF	PREVIOUS PAGE
S-VHS ET	OFF	VIDEO STABILIZER	OFF	REAR AUX INPUT
VIDEO CALIBRATION	ON	BLUE BACK	ON	VIDEO
PICTURE CONTROL	AUTO	2ND AUDIO RECORD	OFF	
AUTO TIMER	OFF	AUDIO MONITOR	HI-FI	
SUPERIMPOSE	OFF	S-VHS MODE	ON	
AUTO SP-EP TIMER	OFF	AV COMPU-LINK	ON	
NEXT PAGE		NEXT PAGE		
SELECT WITH (▲▼) AND (OK) PRESS (MENU) TO END		SELECT WITH (▲▼) AND (OK) PRESS (MENU) TO END		SELECT WITH (▲▼) AND (OK) PRESS (MENU) TO END

3 Change setting

Press **OK** or ▶. The default setting is **bold** in the table below. Press **MENU** to return to normal screen.

After a power failure occurs, Function Settings will be reset to its default setting.

■ S-VHS ET — ON/OFF

When this function is set to "ON", you can record on VHS cassettes with S-VHS picture quality. Tapes recorded using this function can be played back on a S-VHS VCR equipped with the S-VHS ET function or VHS VCR equipped with the SQPB (S-VHS QUASI PLAYBACK) function.

When this function is set to "ON", the S-VHS indicator lights up on the display panel.

NOTES:

- Before recording, set "VIDEO CALIBRATION" to "ON". (See below)
- You cannot activate the S-VHS ET function while recording, timer-recording or Instant Timer Recording (see pg. 11) or the "VIDEO CALIBRATION" function (See below) is in progress.
- The S-VHS ET function does not work with S-VHS cassettes.
- To keep the highest quality recording and playback pictures over a long period of time, S-VHS recording on S-VHS cassettes is recommended.
- Use of high grade tapes is recommended for S-VHS ET recordings. On some tapes, picture quality will not improve even if the S-VHS ET function is used. Check the recording quality before you start important recordings.

■ VIDEO CALIBRATION — ON/OFF

When this function is set to "ON", this VCR checks the condition of the tape in use during playback and recording, and compensates to provide the highest-possible pictures. This takes place whenever you play back a tape or start recording after inserting a tape.

NOTE:

The VCR checks the tape condition for about 7 seconds, then starts recording. To make sure you record the desired scene or program completely, perform the following steps:

- 1 Press and hold **PAUSE** (II), and press **REC** (●). After about 7 seconds, the VCR re-enters Record Pause mode.
- 2 Press **PLAY** (▶) to start recording.

■ PICTURE CONTROL — AUTO(NORM)/EDIT/SOFT/SHARP

This function helps you to adjust the playback picture quality according to your preference.

AUTO (NORM): Normally select this. Picture quality is adjusted automatically. When "VIDEO CALIBRATION" is "OFF", "NORM" will appear instead of "AUTO".

EDIT: Minimizes picture degradation during editing (recording and playback).

SOFT: Reduces image coarseness when viewing overlaid tapes containing much noise.

SHARP: Clearer, sharper-edged picture when viewing images with much flat, same-colored surfaces such as cartoons.

NOTE:

Select "EDIT" when you are editing tapes. After you finish editing the tapes, select "AUTO".

■ AUTO TIMER — ON/OFF

● When this function is set to "ON":

The timer recording standby mode is automatically engaged when the VCR is turned off. It is temporarily canceled when the VCR is turned on. You do not have to press **TIMER** to engage or disengage the timer recording standby mode.

● When this function is set to "OFF":

You have to press **TIMER** to engage or disengage the timer recording standby mode.

■ SUPERIMPOSE — ON/OFF

When this function is set to "ON", various VCR status information (on-screen display) appears on the screen.

NOTE:

When you use this VCR as the playback VCR for editing a tape, be sure to set this function to "OFF"; otherwise, the VCR status information (on-screen display) will be recorded on the edited tape.

■ AUTO SP→EP TIMER — ON/OFF

When this function is set to "ON", the VCR automatically switches to EP mode to allow complete recording if there is not enough tape to record the entire program while timer-recording in SP mode.

For Example, Recording a program of 140 minutes in length onto a 120-minute tape

Approximately 110 minutes Approximately 30 minutes

SP mode	EP mode
---------	---------

NOTES:

- If you have programed the VCR to timer-record 2 or more programs, do not use this function, but change the tape speed manually during timer programming.
- There may be some noise and sound disturbance where the tape speed switches from SP to EP mode on the tape.
- This function is not available during ITR (Instant Timer Recording), and will not work properly on the following tapes: T(ST)-30, T(ST)-60, T(ST)-90, and T(ST)-120.

■ VIDEO STABILIZER — ON/OFF

When this function is set to "ON", you can automatically correct vertical vibrations in the picture when playing back unstable recordings made on another VCR.

NOTE:

To watch recordings with close-caption or when you finish viewing a tape, set this function to "OFF".

■ BLUE BACK — ON/OFF

When this function is set to "ON", the TV screen becomes all blue when receiving a channel not in use.

NOTE:

When you want to receive an unstable channel with poor signals, set this function to "OFF".

■ 2ND AUDIO RECORD — ON/OFF

● When this function is set to "ON";

If a SAP program is received, the SAP audio is recorded on both the normal and Hi-Fi tracks. The main audio is not recorded.

If a non-SAP program is received, the main audio is recorded on both the Hi-Fi and normal tracks.

● When this function is set to "OFF", the SAP audio cannot be recorded.

NOTES:

When the channel is changed on the VCR;

- The "STEREO" indication appears on the screen for about 5 seconds if the program is a stereo broadcast.
- The "SAP" indication appears on the screen for about 5 seconds if the program is a SAP broadcast.
- Both indications appear when a stereo program is accompanied by SAP sound.

■ AUDIO MONITOR — HI-FI/HI-FI L/HI-FI R/NORM/MIX

This VCR can record two sound tracks simultaneously (normal and Hi-Fi) on a Hi-Fi stereo tape. You can select the sound track(s) to listen to while playing back a Hi-Fi stereo tape. In addition, when playing back a prerecorded tape containing two separate audio programs on the Hi-Fi tracks, you can choose either one by selecting either "HI-FI L" or "HI-FI R".

HI-FI: Normally select this. Hi-Fi sound is played back.

HI-FI L: Sound on the left Hi-Fi channel is played back.

HI-FI R: Sound on the right Hi-Fi channel is played back.

NORM: Sound on the normal track is played back.

MIX: Both sounds on the Hi-Fi track and normal track are mixed and played back.

NOTES:

- While playing back a monaural tape, sounds on the normal track will be heard regardless of this setting.
- If RF connection (☞ pg. 5) is used for viewing pictures on the TV, sound will be monaural even though you select "HI-FI".
- You can also use the **A.MONITOR** button on the Remote to select the desired monitor sound. (☞ pg. 9)

■ S-VHS MODE — ON/OFF

You can determine which recording mode — either S-VHS mode or VHS mode — is used for recording on S-VHS tapes.

- When this function is set to "ON", you can record on S-VHS tapes with S-VHS picture quality.
- When this function is set to "OFF", you can record on S-VHS tapes with VHS picture quality.

NOTES:

- S-VHS mode allows you to make high quality video recordings with horizontal resolution of 400 lines, comparing with the 230 lines of resolution of conventional VHS recordings. To achieve the highest quality picture we recommended to record in S-VHS mode. (But remember that a conventional VHS VCR without SQPB cannot play back S-VHS tapes recorded in S-VHS mode.)
- S-VHS MODE setting does not affect recording on VHS tapes. Recording on VHS tapes is always performed in VHS mode except when using S-VHS ET mode (☞ pg. 15).

■ AV COMPU-LINK — ON/OFF

The remote PAUSE/AV COMPULINK terminal on the rear panel can be used as either the remote PAUSE terminal or the AV COMPULINK terminal.

- When this function is set to "ON", you can use this terminal as the AV COMPULINK terminal. By connecting other JVC's AV COMPULINK components, including amplifiers (or receivers) and televisions, one touch control of the audio and video components linked via their AV COMPULINK connectors becomes possible.
- When this function is set to "OFF", you can use this terminal as the remote PAUSE terminal. If your JVC camcorder is equipped with the Master Edit Control, you can control the VCR from the camcorder. Connect the mini-plug cable (not supplied with this VCR) between the remote PAUSE terminal and the EDIT connector on the camcorder.

NOTE:

Refer to the other components' instruction manuals for connection and its operations.

■ REAR AUX INPUT — VIDEO/S-VIDEO

You have to select which terminal — either VIDEO (composite) or S VIDEO (Y/C separate signals) to use as the video input terminal on the rear panel.

Make sure you select the correct terminal; otherwise, you may fail in recording (editing) on this VCR.

Satellite Auto Recording

You can automatically record a satellite program which is timer-programmed on your DBS receiver.

- 1 Connect a DBS receiver to the AUDIO/VIDEO IN connectors on the rear panel. You can also connect the cable box if it has a timer.
- 2 Set timer program on DBS receiver referring to its instruction manual.
- 3 Load a cassette with the record safety tab intact.
- 4 Press **SP/EP** to set the tape speed. The selected tape speed will appear on the TV screen.
- 5 Press **REC LINK** for more than 2 seconds. The VCR turns off automatically and enter the Satellite Auto Recording standby mode ("L-1" and "⊕" light up). When signals come into the VCR from the DBS receiver, the VCR starts recording ("⊕" and "○" light up and "L-1" blinks). When no signals coming in, recording stops. "○" indicator goes off.

NOTES:

- Be sure not to turn on the DBS receiver before the program starts broadcasting; otherwise, the VCR will start recording when the DBS receiver is turned on.
- To disengage the Satellite Auto Recording standby mode, press **REC LINK** ("⊕" lights off).
- Depending on the type of satellite receiver, Satellite Auto Recording may not be compatible.

Child Lock

You can disable the VCR operations. While the VCR is turned on, press and hold **POWER** ⏻ on the Remote for more than 10 seconds. The VCR turns off, "CL" appears for about 5 seconds on the display panel.

To release the child lock, press and hold **POWER** ⏻ on the Remote until the VCR turns on.

NOTES:

- Pressing **TIMER** during timer recording, unplugging the AC power cord or a power outage also releases the child lock.
- When the child lock function is in use, keep the Remote out of the children's reach.
- Timer recording programs will be performed even if the child lock function activated.

Multi-Brand Remote Control

This Remote can control some functions of remote controllable TVs, cable boxes or DBS (Direct Broadcast Satellite) receivers listed below. Without setting, you can control a JVC TV.

NOTES:

- Some unit's brands have more than one code. If the unit does not function with a specified code, try other codes.
- Depending on the type of unit, some or all functions cannot be operated using this Remote.
- It is not possible to operate a unit not equipped with a remote sensor.
- It is not possible to set the Remote for both your cable box and a DBS receiver at the same time.
- Once you have set the Remote to operate the unit, you do not have to set it until you replace the batteries from the Remote.
- If the batteries of the Remote are discharged, the Remote may not be able to control the TV, cable box or DBS receiver. Replace the batteries.

TV Brand Setting

1 Turn on TV

Turn on the TV using the Power button on the TV or its Remote.

2 Set TV brand code

- 1 Press and hold **TV**.
- 2 Press **MBR SET**.
- 3 Press the **Number keys** to enter your TV's brand code.
- 4 Press **OK**, and release **TV**. The TV should turn off.

3 Operate TV

While holding down **TV**, press one of the following buttons: **POWER** ψ /I, **TV/VCR**, **TV CH+/-**, μ / \boxtimes (TV Muting), **TV VOL+/-**, and the **Number keys**.

- For some brands, you must press **ENTER** after having pressed the **Number keys** to enter a channel number.

TV BRAND	CODE	TV BRAND	CODE
JVC	01, 03	SONY	07
HITACHI	10	SAMSUNG	12
MAGNAVOX	02	SANYO	13
MITSUBISHI	03	SEARS	13
PANASONIC	04, 11	TOSHIBA	08
RCA	05	ZENITH	09
SHARP	06		

Cable Box or DBS Receiver Brand Setting

1 Turn on cable box or DBS receiver

Turn on the cable box or DBS receiver using the Power button on the unit or its Remote.

2 Enter brand code

- 1 Press and hold **CABLE/DBS**.
- 2 Press **MBR SET**.
- 3 Press the **Number keys** to enter your cable box's (or DBS receiver's) brand code.
- 4 Press **OK**, and release **CABLE/DBS**.

3 Operate cable box or DBS receiver

While holding down **CABLE/DBS**, press one of the following buttons: **POWER** ψ /I, **TV CH+/-**, and the **Number keys**.

- For some brands, you must press **ENTER** after having pressed the **Number keys** to enter a channel number.
- To change the cable box's (or DBS receiver's) channels, press **TV CH+/-** or the **Number keys**. (The **CH+/-** button can be used to change the VCR's channels only.)

CABLE BOX BRAND	CODE
ARCHER	01, 05, 17
CABLETENNA	01, 17
CABLEVIEW	15, 16, 17, 21, 25
CITIZEN	15, 16, 17, 21, 25
CURTIS	02
DIAMOND	01, 17
GC BRAND	15, 16, 17, 21, 25
GEMINI	15
GENERAL INSTRUMENTS	01, 04, 06, 11, 12, 15, 28
HAMLIN	10, 18, 23
JASCO	15
JERROLD	01, 04, 06, 11, 12, 15, 28
NOVAVISION	02
OAK	07
PANASONIC	13, 14
PULSER	15, 16, 17, 21, 25
RCA	13, 14
REGAL	10, 18, 23
REMBRANDT	01, 16, 17
SAMSUNG	05, 16, 24
SCIENTIFIC ATLANTA	02
SIGMA	07
SL MARX	05, 16, 17, 24, 25
SPRUCER	13, 14
STARGATE	05, 15, 16, 17, 21, 24, 25
TELEVIEW	05, 16, 24
TOCOM	01, 04, 16
UNIKA	01, 17
UNIVERSAL	16, 17, 25
VIDEOWAY	03, 09, 22
ZENITH	03, 09, 22

DBS RECEIVER BRAND	CODE
JVC (DISH Network)	51
ECHOSTAR (DISH Network)	51
SONY (DSS)	41
RCA (DSS)	40

Changing Remote Control Code

This Remote is capable of transmitting two control codes; one set to respond to A code control signals and another set to respond to B code control signals. This Remote control is preset to send A code signals because your VCR is initially set to respond to A code signals. You can easily modify your VCR and the Remote to respond to B code signals. When using two JVC VCRs, set two VCRs and their Remotes to different codes, so that you can operate these VCRs separately.

1 Set remote control code for Remote

- 1 Press and hold **A/B**.
- 2 Press the **Number key "2"**.
- 3 Press **OK**, and release **A/B**.

- The Remote now can transmit B code control signals.

2 Check remote control code for VCR

Press and hold \blacktriangleright on the VCR for more than 5 seconds while the VCR is turned off. The code currently set appears on the display panel.

3 Change code for VCR

Press any key on the Remote. The VCR now responds to B code control signals.

- To set the Remote and the VCR back to A code control signals, repeat the same procedure as shown above except pressing the **Number key "1"** in step 2 of 1.

To control two VCRs with the same Remote

You can control two JVC VCRs by switching the remote control code for the Remote between A and B (\blacktriangleleft step 1), keeping two VCRs to different control codes.

- To change only the remote control code for the Remote, DO NOT perform steps 2 and 3.

Editing

You can use your VCR as the playback or recording VCR. You can use a camcorder as the playback VCR and your VCR as the recording VCR. Refer also to the other components' instruction manuals for connection and its operations.

1 Make connections

Example 1: When another VCR is VHS VCR

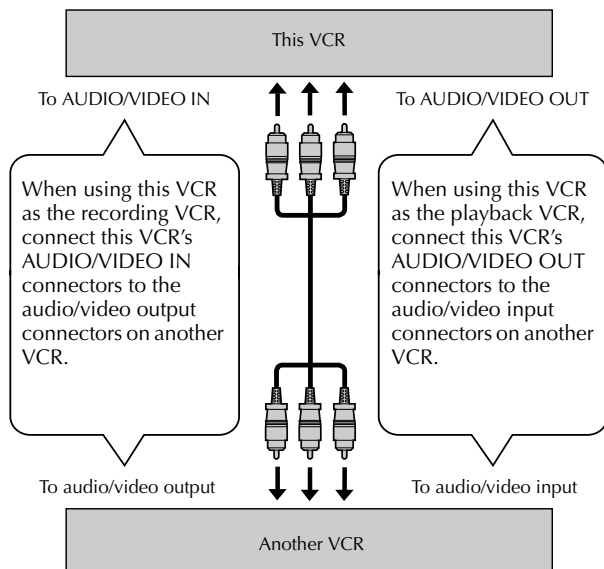

- If another VCR is monaural, connect this VCR's AUDIO L IN (or OUT) connector to the audio output (or input) connector on another VCR.

Example 2: When another VCR is S-VHS VCR equipped with S-VIDEO input connector and when using this VCR as the playback VCR

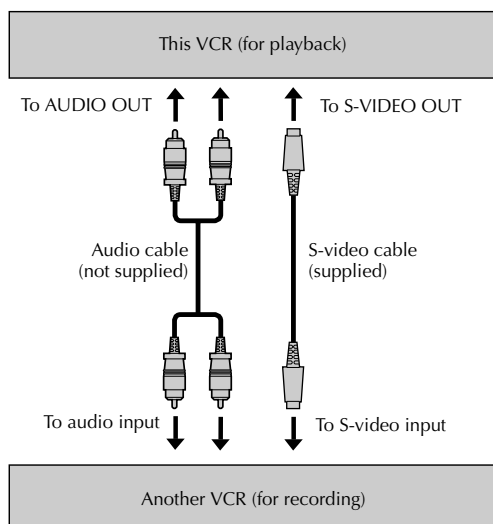

Example 3: When another VCR is S-VHS VCR and when using this VCR as the recording VCR

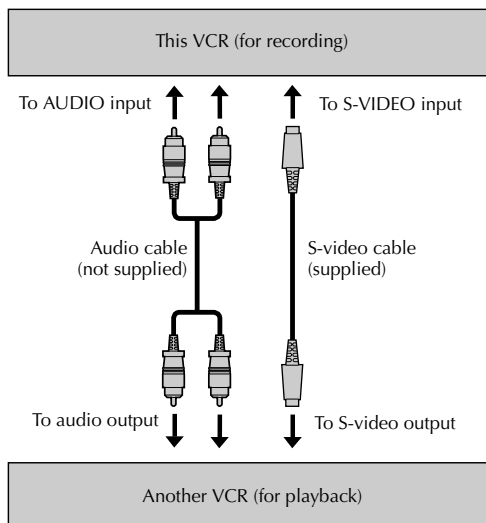

2 Load cassettes

Insert the playback cassette into the playback VCR and the cassette to be recorded on into the recording VCR.

3 Select input mode on recording VCR

Select the correct external input on the recording VCR. On this VCR (when using this VCR as the recording VCR); Select "L-1" — when connecting the other VCR to the audio/video input connectors on the rear panel.

Select "F-1" — when connecting the other VCR to the audio/video input connectors on the front panel.

Press **AUX** or **CH+/-** on the Remote. Or push the **JOG** dial, then turn it to the left or right.

4 Select video input connector on recording VCR

When using this VCR as the recording VCR, select the appropriate mode depending on the connector being used (☞ pg. 16).

When using S-VIDEO IN connector on the rear panel, set "REAR AUX INPUT" to "S-VIDEO".

When using VIDEO IN connector on the rear panel, set "REAR AUX INPUT" to "VIDEO".

5 Select edit mode

Set the edit mode to "ON" for the VCRs if such a mode is equipped.

- On this VCR, set "PICTURE CONTROL" to "EDIT" (☞ pg. 15).

6 Start playback

Press **PLAY** (▶) on the playback VCR.

7 Start recording

Press **REC** (●) on the recording VCR.

Various connection for editing tapes

The following three methods can be used for editing tapes.

- **VHS to S-VHS editing (VIDEO-VIDEO connection):** Although the picture quality is inherently limited by the original VHS quality, the edited tape has better picture quality than those made by VHS-to-VHS editing.
- **S-VHS to VHS editing (VIDEO-VIDEO connection):** Since the original source is recorded in S-VHS mode, the edited tape has better picture quality than those made by VHS-to-VHS editing.
- **S-VHS to S-VHS (S-VIDEO connection):** Original picture quality of S-VHS made can be duplicated with minimal picture degradation. This is the best editing method you can use on S-VHS VCRs.

Specifications

GENERAL

Power requirement	: AC 120 V~, 60 Hz
Power consumption	
Power on	: 17 W
Power off	: 1.5 W
Temperature	
Operating	: 5°C to 40°C (41°F to 104°F)
Storage	: -20°C to 60°C (-4°F to 140°F)
Operating position	: Horizontal only
Dimensions (W x H x D)	: 435 mm x 94 mm x 247 mm (17-3/16" x 3-3/4" x 9-3/4")
Weight	: 2.8 kg (6.2 lbs)
Format	: S-VHS/VHS NTSC standard
Maximum recording time	
SP	: 210 min. with ST-210 video cassette
EP	: 630 min. with ST-210 video cassette

VIDEO/AUDIO

Signal system	: NTSC-type color signal and EIA monochrome signal, 525 lines/60 fields
Recording/Playback system	: DA-4 (Double Azimuth) head helical scan system
Signal-to-noise ratio	: 45 dB
Horizontal resolution	
VHS	: 230 lines
S-VHS	: 400 lines
Frequency range	
Normal audio	: 70 Hz to 10,000 Hz
Hi-Fi audio	: 20 Hz to 20,000 Hz
Input/Output	: RCA connectors (IN x 2, OUT x 1) S-video connectors (IN x 1, OUT x 1)

TUNER

Tuning system	: Frequency-synthesized tuner
Channel coverage	
VHF	: Channels 2-13
UHF	: Channels 14-69
CATV	: 113 Channels
RF output	: Channel 3 or 4 (switchable; preset to Channel 3 when shipped) 75 ohms, unbalanced

TIMER

Clock reference	: Quartz
Program capacity	: 1-year programmable timer/8 programs
Memory backup for timer	is not supported.

ACCESSORIES

Provided accessories	: Infrared remote control unit, "AA" battery x 2, S-video cable (4-pin), RF cable (F-type)
----------------------	---

Specifications shown are for SP mode unless specified otherwise. E. & O.E. Design and specifications subject to change without notice.

Troubleshooting

Before requesting service, use this chart and see if you can repair the trouble yourself. Small problems are often easily corrected, and this can save you from the trouble of sending your VCR off for repair.

Power

SYMPTOM	POSSIBLE CAUSE	CORRECTIVE ACTION
The power will not come on.	<ul style="list-style-type: none"> • The AC power cord is disconnected. • The Child Lock function is activated. 	<ul style="list-style-type: none"> • Connect the AC power cord. • Press and hold POWER $\downarrow/1$ for more than 10 seconds to release the Child Lock function (☞ pg. 16).
The clock works, but the VCR's power will not come on.	<ul style="list-style-type: none"> • The VCR is in the timer recording standby mode with "AUTO TIMER" set to "OFF" (☞ pg. 15). • The Child Lock function is activated. 	<ul style="list-style-type: none"> • Press TIMER to disengage the timer. • Press and hold POWER $\downarrow/1$ for more than 10 seconds to release the Child Lock function. (☞ pg. 16)
The Remote will not function.	<ul style="list-style-type: none"> • The batteries are discharged. • The VCR is in the timer recording standby mode. • Remote control A/B code is wrong. 	<ul style="list-style-type: none"> • Replace batteries. • Press TIMER to disengage the timer. • Reset A/B code. (☞ pg. 17)

Playback

SYMPTOM	POSSIBLE CAUSE	CORRECTIVE ACTION
The tape is running but the picture will not appear.	<ul style="list-style-type: none"> • If the RF connection (☞ pg. 5) is used to view the picture, the channel on the TV is set incorrectly. • If the AV or S-video connection (☞ pg. 5) is used to view the picture, the TV receiver is set to the wrong mode. 	<ul style="list-style-type: none"> • Select channel 3 or 4 on the TV. • Select the AV mode on the TV.

Recording

SYMPTOM	POSSIBLE CAUSE	CORRECTIVE ACTION
Recording will not start.	<ul style="list-style-type: none"> • There is no cassette loaded. • The loaded cassette has had its record safety tab removed. 	<ul style="list-style-type: none"> • Insert a cassette on which the record safety tab is intact. • Remove the cassette and cover the hole with adhesive tape, or load a cassette on which the record safety tab is intact.

Timer Recording

SYMPTOM	POSSIBLE CAUSE	CORRECTIVE ACTION
Timer recording will not work.	<ul style="list-style-type: none"> • The clock and/or the timer program have been set incorrectly. • The timer is not engaged. • The VCR has not been set up properly. 	<ul style="list-style-type: none"> • Set the clock and/or timer program correctly. • Press TIMER to engage the timer and make sure that \odot appears on the display panel. • Re-perform the set-up procedures. Make sure you have compensated for guide channel and VCR or cable box channel number mismatches. (☞ pg. 12)
Timer programing will not work.	<ul style="list-style-type: none"> • Timer recording is in progress. 	<ul style="list-style-type: none"> • Timer programing cannot be performed when timer recording is in progress. Wait until it finishes.
Timer recording begins as scheduled, but the channel is always incorrect.	<ul style="list-style-type: none"> • Even though you do not use an external cable box or DBS receiver, "CABLE BOX SET" is set to "ON" or "DBS RECEIVER SET" is set to "ON". 	<ul style="list-style-type: none"> • Set "CABLE BOX SET" to "OFF" or "DBS RECEIVER SET" is set to "OFF". (☞ pg. 7)
You moved, and now VCR Plus+ system does not work properly	<ul style="list-style-type: none"> • The receivable stations in the new area are received on different channels than those in the previous area. 	<ul style="list-style-type: none"> • Re-perform the procedure in "Changing VCR Plus+® Setting" (☞ pg. 12).

Other Problems

SYMPTOM	POSSIBLE CAUSE	CORRECTIVE ACTION
The channel cannot be changed.	<ul style="list-style-type: none"> • Recording is in progress. 	<ul style="list-style-type: none"> • Press PAUSE (II) to pause the recording, change channels, then press PLAY (▶) to resume recording.
Even though Auto or Semiauto Clock Set has been performed, the clock is incorrect.	<ul style="list-style-type: none"> • The clock setting data received from the host channel is incorrect. 	<ul style="list-style-type: none"> • Select a different host channel during Semiauto Clock Set (☞ pg. 6), or perform Manual Clock Set (☞ pg. 6).

FOR SERVICING (Only in U.S.A.)

HOW TO LOCATE YOUR JVC SERVICE CENTER

TOLL FREE: 1-800-537-5722

<http://www.jvc.com>

Dear Customer,

In order to receive the most satisfaction from your purchase, please read the instruction booklet before operating the unit. In the event that repair is necessary, or for the address nearest your location within the Continental United States, please call 1-800-537-5722 for your nearest authorized servicer or visit our website at www.JVC.com. Remember to retain your Bill of Sale for Warranty Service.

— JVC

JVC SERVICE & ENGINEERING COMPANY OF AMERICA

DIVISION OF JVC AMERICAS CORP.

Sophisticated electronic products may require occasional service. Just as quality is a keyword in the engineering and production of the wide array of JVC products, service is the key to maintaining the high level performance for which JVC is world famous. The JVC service and engineering organization stands behind our products.

NATIONAL HEADQUARTERS
JVC SERVICE & ENGINEERING COMPANY OF AMERICA
DIVISION OF JVC AMERICAS CORP.
10 New Maple Avenue
Pine Brook, NJ 07058-9641

ACCESSORIES

*To purchase accessories for your JVC product, you may contact your local JVC Dealer.
From the 48 Continental United States call toll free:
1-800-882-2345 or on the web at www.JVC.com*

Don't service the product yourself.

CAUTION

*To prevent electrical shock, do not open the cabinet.
There are no user serviceable parts inside.
Please refer to qualified service personnel for repairs.*

WARRANTY (Only in U.S.A.)

LIMITED WARRANTY CONSUMER VIDEO 1-90

JVC COMPANY OF AMERICA warrants this product and all parts thereof, except as set forth below ONLY TO THE ORIGINAL PURCHASER AT RETAIL to be FREE FROM DEFECTIVE MATERIALS AND WORKMANSHIP from the date of original retail purchase for the period as shown below. ("The Warranty Period")

PARTS	LABOR
1 YR	90 DAYS

THIS LIMITED WARRANTY IS VALID ONLY IN THE FIFTY (50) UNITED STATES, THE DISTRICT OF COLUMBIA AND IN COMMONWEALTH OF PUERTO RICO.

WHAT WE WILL DO:

If this product is found to be defective, JVC will repair or replace defective parts at no charge to the original owner. Such repair and replacement services shall be rendered by JVC during normal business hours at JVC authorized service centers. Parts used for replacement are warranted only for the remainder of the Warranty Period. All products and parts thereof may be brought to a JVC authorized service center on a carry-in basis except for Television sets having a screen size 25 inches and above which are covered on an in-home basis.

WHAT YOU MUST DO FOR WARRANTY SERVICE:

Return your product to a JVC authorized service center with a copy of your bill of sale. For your nearest JVC authorized service center, please call toll free: (800) 537-5722.

If service is not available locally, box the product carefully, preferably in the original carton, and ship, insured, with a copy of your bill of sale plus a letter of explanation of the problem to the nearest JVC Factory Service Center, the name and location of which will be given to you by the toll-free number.

If you have any questions concerning your JVC Product, please contact our Customer Relations Department.

WHAT IS NOT COVERED:

This limited warranty provided by JVC does not cover:

1. Products which have been subject to abuse, accident, alteration, modification, tampering, negligence, misuse, faulty installation, lack of reasonable care, or if repaired or serviced by anyone other than a service facility authorized by JVC to render such service, or if affixed to any attachment not provided with the products, or if the model or serial number has been altered, tampered with, defaced or removed;
2. Initial installation and installation and removal for repair;
3. Operational adjustments covered in the Owner's Manual, normal maintenance, video and audio head cleaning;
4. Damage that occurs in shipment, due to act of God, and cosmetic damage;
5. Signal reception problems and failures due to line power surge;
6. Video Pick-up Tubes/CCD Image Sensor, Cartridge, Stylus (Needle) are covered for 90 days from the date of purchase;
7. Accessories;
8. Batteries (except that Rechargeable Batteries are covered for 90 days from the date of purchase);

There are no other express warranties except as listed above.

THE DURATION OF ANY IMPLIED WARRANTIES INCLUDING THE IMPLIED WARRANTY OF MERCHANTABILITY, IS LIMITED TO THE DURATION OF THE EXPRESS WARRANTY HEREIN.

JVC SHALL NOT BE LIABLE FOR THE LOSS OF USE OF THE PRODUCT, INCONVENIENCE, LOSS OR ANY OTHER DAMAGES, WHETHER DIRECT, INCIDENTAL OR CONSEQUENTIAL (INCLUDING, WITHOUT LIMITATION, DAMAGE TO TAPES, RECORDS OR DISCS) RESULTING FROM THE USE OF THIS PRODUCT, OR ARISING OUT OF ANY BREACH OF THIS WARRANTY. ALL EXPRESS AND IMPLIED WARRANTIES, INCLUDING THE WARRANTIES OF MERCHANTABILITY AND FITNESS FOR PARTICULAR PURPOSE, ARE LIMITED TO THE WARRANTY PERIOD SET FORTH ABOVE.

Some states do not allow the exclusion of incidental or consequential damages or limitations on how long an implied warranty lasts, so these limitations or exclusions may not apply to you. This warranty gives you specific legal rights and you may also have other rights which vary from state to state.

JVC COMPANY OF AMERICA
DIVISION OF JVC AMERICAS CORP.

1700 Valley Road
Wayne, New Jersey 07470

REFURBISHED PRODUCTS CARRY A SEPARATE WARRANTY, THIS WARRANTY DOES NOT APPLY. FOR DETAILS OF REFURBISHED PRODUCT WARRANTY, PLEASE REFER TO THE REFURBISHED PRODUCT WARRANTY INFORMATION PACKAGED WITH EACH REFURBISHED PRODUCT.

For customer use:

Enter below the Model No. and Serial No. which is located either on the rear, bottom or side of the cabinet. Retain this information for future reference.

Model No.: _____

Serial No.: _____

Purchase date: _____

Name of dealer: _____

