

# JVC®

## COLOR TELEVISION USER'S GUIDE

# I'Art™

For models:

AV-36F802

AV-36F702

AV-32F802

AV-32F702

AV-27F802

AV-27F702



Illustration of AV-27F802 and RM-C301G

### IMPORTANT NOTE TO THE CUSTOMER

In the spaces below, enter the model and serial number of your television (located at the rear of the television cabinet). Staple your sales receipt or invoice to the inside cover of this guide. Keep this user's guide in a convenient place for future reference. Keep the carton and original packaging for future use.

---





Serial Number

---

Model Number

LCT0821-001D-A  
0901-TN-FAA-JIM

# IMPORTANT SAFETY PRECAUTIONS

	<b>CAUTION</b> <b>RISK OF ELECTRIC SHOCK</b> <b>DO NOT OPEN</b>	
<p><b>CAUTION: To reduce the risk of electric shock.</b> <b>Do not remove cover (or back).</b> <b>No user serviceable parts inside.</b> <b>Refer servicing to qualified service personnel.</b></p>		
	<p>The lightning flash with arrowhead symbol, within an equilateral triangle is intended to alert the user to the presence of uninsulated "dangerous voltage" within the product's enclosure that may be of sufficient magnitude to constitute a risk of electric shock to persons.</p>	
	<p>The exclamation point within an equilateral triangle is intended to alert the user to the presence of important operating and maintenance (servicing) instructions in the literature accompanying the appliance.</p>	

**WARNING:** TO PREVENT FIRE OR SHOCK HAZARDS, DO NOT EXPOSE THIS TV SET TO RAIN OR MOISTURE.

**CAUTION:** TO INSURE PERSONAL SAFETY, OBSERVE THE FOLLOWING RULES REGARDING THE USE OF THIS UNIT.

1. Operate only from the power source specified on the unit.
2. Avoid damaging the AC plug and power cord.
3. Avoid Improper installation and never position the unit where good ventilation is unattainable.
4. Do not allow objects or liquid into the cabinet openings.
5. In the event of trouble, unplug the unit and call a service technician. Do not attempt to repair it yourself or remove the rear cover.

Changes or modifications not approved by JVC could void the warranty.

\* When you don't use this TV set for a long period of time, be sure to disconnect both the power plug from the AC outlet and antenna for your safety.

\* To prevent electric shock do not use this polarized plug with an extension cord, receptacle or other outlet unless the blades can be fully inserted to prevent blade exposure.

# IMPORTANT SAFEGUARDS

## CAUTION:

### **Please read and retain for your safety.**

Electrical energy can perform many useful functions. This TV set has been engineered and manufactured to assure your personal safety. But *improper use can result in potential electrical shock or fire hazards*. In order not to defeat the safeguards incorporated in this TVset, observe the following basic rules for its installation, use and servicing. And also follow all warnings and instructions marked on your TV set.

## INSTALLATION

- 1 Your TV set is equipped with a polarized AC line plug (one blade of the plug is wider than the other).

(POLARIZED-TYPE)

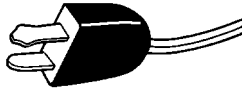

This safety feature allows the plug to fit into the power outlet only one way. Should you be unable to insert the plug fully into the outlet, try reversing the plug. Should it still fail to fit, contact your electrician.

- 2 Operate the TVset only from a power source as indicated on the TV set or refer to the operating instructions for this information. If you are not sure of the type of power supply to your home, consult your TV set dealer or local power company. For battery operation, refer to the operating instructions.
- 3 Overloaded AC outlets and extension cords are dangerous, and so are frayed power cords and broken plugs. They may result in a shock or fire hazard. Call your service technician for replacement.
- 4 Do not allow anything to rest on or roll over the power cord, and do not place the TV set where power cord is subject to traffic or abuse. This may result in a shock or fire hazard.
- 5 Do not use this TV set near water — for example, near a bathtub, washbowl, kitchen sink, or laundry tub, in a wet basement, or near swimming pool, etc.
- 6 If an outside antenna is connected to the TV set, be sure the antenna system is grounded so as to provide some protection against voltage surges and built-up static charges. Section 810 of the National Electrical Code provides information with respect to proper grounding of the mast and supporting structure, grounding of the lead-in wire to an antenna discharge unit, size of grounding conductors, location of antenna discharge unit, connection requirements for the grounding electrode.

- 7 An outside antenna system should not be located in the vicinity of overhead power lines or other electric light or power circuits, or where it can fall into such power lines or circuits. When installing an outside antenna system, extreme care should be taken to keep from touching such power lines or circuits as contact with them might be fatal.

### EXAMPLE OF ANTENNA GROUNDING AS PER NATIONAL ELECTRICAL CODE

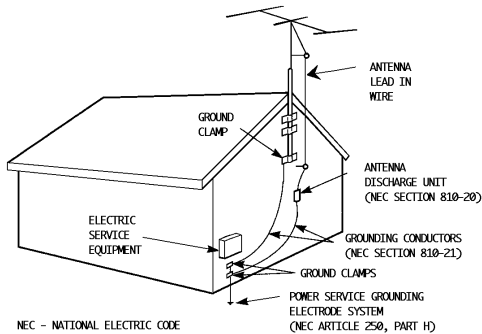

- 8 TV sets are provided with ventilation openings in the cabinet to allow heat generated during operation to be released.

Therefore:

- Never block the bottom ventilation slots of a portable TV set by placing it on a bed, sofa, rug, etc.
  - Never place a TV set in a “built-in” enclosure unless proper ventilation is provided.
  - Never cover the openings with a cloth or other material.
  - Never place the TV set near or over a radiator or heat register.
- 9 To avoid personal injury:
- Do not place a TV set on a sloping shelf unless properly secured.
  - Use only a cart or stand recommended by the TVset manufacturer.
  - Do not try to roll a cart with small casters across thresholds or deep pile carpets.
  - Wall or shelf mounting should follow the manufacturer’s instructions, and should use a mounting kit approved by the manufacturer.

### USE

- 10 Caution children about dropping or pushing objects into the TV set through cabinet openings. Some internal parts carry hazardous voltages and contact can result in a fire or electrical shock.
- 11 Unplug the TV set from the wall outlet before cleaning. Do not use liquid or an aerosol cleaner.
- 12 Never add accessories to a TV set that has not been designed for this purpose. Such additions may result in a hazard.

- 13 For added protection of the TV set during a lightning storm or when the TV set is to be left unattended for an extended period of time, unplug it from the wall outlet and disconnect the antenna. This will prevent damage to product due to lightning storms or power line surges.
- 14 A TV set and cart combination should be moved with care. Quick stops, excessive force, and uneven surfaces may cause the TV set and cart combination to overturn.



## SERVICE

- 15 Unplug this TV set from the wall outlet and refer servicing to qualified service personnel under the following conditions:
- A. When the power cord or plug is damaged or frayed.
  - B. If liquid has been spilled into the TV set.
  - C. If the TV set has been exposed to rain or water.
  - D. If the TV set does not operate normally by following the operating instructions. Adjust only those controls that are covered in the operating instructions as improper adjustment of other controls may result in damage and will often require extensive work by a qualified technician to restore the TV set to normal operation.
  - E. If the TV set has been dropped or damaged in any way.
  - F. When the TV set exhibits a distinct change in performance — this indicates a need for service.
- 16 Do not attempt to service this TV set yourself as opening or removing covers may expose you to dangerous voltage or other hazards. Refer all servicing to qualified service personnel.
- 17 When replacement parts are required, have the service technician verify in writing that the replacement parts he uses have the same safety characteristics as the original parts. Use of manufacturer's specified replacement parts can prevent fire, shock, or other hazards.
- 18 Upon completion of any service or repairs to this TV set, please ask the service technician to perform the safety check described in the manufacturer's service literature.
- 19 When a TV set reaches the end of its useful life, improper disposal could result in a picture tube implosion. Ask a qualified service technician to dispose of the TV set.
- 20 Note to CATV system installer.  
This reminder is provided to call the CATV system installer's attention to Article 820-40 of the NEC that provides guidelines for proper grounding and, in particular, specifies that the cable ground shall be connected to the grounding system of the building, as close to the point of cable entry as practical.

# Table of Contents

---

<b>UNPACKING YOUR TV . . . . .</b>	<b>7</b>	<b>PICTURE SETTINGS . . . . .</b>	<b>34</b>
<b>QUICK SETUP . . . . .</b>	<b>8</b>	Tint . . . . .	34
Getting Started . . . . .	8	Color . . . . .	34
Remote Control . . . . .	8	Picture . . . . .	34
Batteries . . . . .	8	Bright . . . . .	34
Basic Operation . . . . .	8	Detail . . . . .	34
Making Basic Connections . . . . .	9	Noise Muting . . . . .	35
Plug In Menu . . . . .	10	Set Video Status . . . . .	35
<b>CONNECTIONS . . . . .</b>	<b>11</b>	<b>SOUND SETTINGS . . . . .</b>	<b>36</b>
Cable and VCR Connections . . . . .	11	Bass . . . . .	36
Connecting to a DVD Player . . . . .	14	Treble . . . . .	36
Connecting to an External Amplifier . . . . .	15	Balance . . . . .	36
Connecting to a Camcorder . . . . .	15	MTS (Multi-channel Sound) . . . . .	36
Connecting to JVC AV Compu Link . . . . .	6	<b>GENERAL ITEMS . . . . .</b>	<b>37</b>
<b>REMOTE CONTROL . . . . .</b>	<b>17</b>	Purity . . . . .	37
Remote Control Basics . . . . .	17	On/Off Timer . . . . .	37
Changing the Batteries . . . . .	17	TV Speaker . . . . .	38
<b>REMOTE PROGRAMMING . . . . .</b>	<b>18</b>	Audio Out . . . . .	38
CATV and Satellite Codes . . . . .	18	V4 Component-In/ V2 Component-In . . . . .	39
VCR Codes . . . . .	19	Closed Caption . . . . .	39
DVD Codes . . . . .	20	<b>BUTTON FUNCTIONS . . . . .</b>	<b>40</b>
<b>ONSCREEN MENUS . . . . .</b>	<b>21</b>	Menu . . . . .	40
Using the Guide . . . . .	21	Exit and PIP Off . . . . .	40
The Onscreen Menus . . . . .	21	Display . . . . .	40
<b>PLUG IN MENU . . . . .</b>	<b>22</b>	Video Status . . . . .	41
Introduction . . . . .	22	Sleep Timer . . . . .	41
Language . . . . .	22	Hyper Surround . . . . .	41
Auto Tuner Setup . . . . .	22	Muting . . . . .	41
Auto Clock Set . . . . .	23	BBE . . . . .	42
Manual Clock Set . . . . .	24	100+ . . . . .	42
Finish . . . . .	24	Return+ . . . . .	42
<b>CHANNEL SUMMARY . . . . .</b>	<b>25</b>	Input . . . . .	42
Channel Summary . . . . .	25	VCR Buttons . . . . .	43
<b>V-CHIP . . . . .</b>	<b>26</b>	DVD Buttons . . . . .	43
US V-Chip Ratings . . . . .	27	TV/CATV Switch . . . . .	43
Setting US V-Chip Ratings . . . . .	28	VCR/DVD Switch . . . . .	43
Directions . . . . .	28	Light . . . . .	43
Set Ratings . . . . .	29	<b>PIP (Picture-In-Picture) . . . . .</b>	<b>44</b>
Movie Ratings . . . . .	30	Introduction . . . . .	44
Directions for Movie Settings . . . . .	30	On/Move . . . . .	44
Canadian V-Chip Ratings . . . . .	31	Freeze . . . . .	45
Canadian V-Chip Directions . . . . .	31	Swap . . . . .	45
Unrated Programs . . . . .	32	Channel +/- . . . . .	45
Set Lock Code . . . . .	33	Source . . . . .	45
<b>APPENDICES . . . . .</b>	<b>46</b>	Troubleshooting . . . . .	46
Warranty . . . . .	47	Authorized Service Centers . . . . .	49
Authorized Service Centers . . . . .	49	Search Codes . . . . .	50
Search Codes . . . . .	50	Specifications . . . . .	51
Specifications . . . . .	51		

# Unpacking Your Television

Thank you for your purchase of a JVC Color Television. Before you begin setting up your new television, please check to make sure you have all of the following items. In addition to this guide, your television box should include:

1 Television

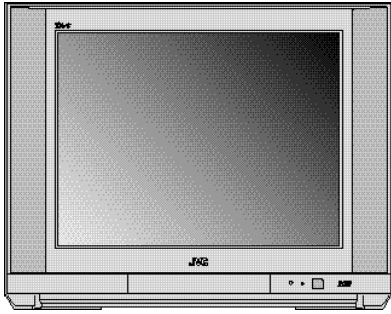

1 Remote Control

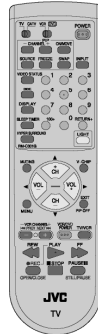

Two AA Batteries



*A matching TV stand is also available (optional).*

*Note: Your remote control may differ from the example illustrated here.*

Once you have unpacked your television, the next step is to connect it to your antenna/cable or satellite system and to connect the audio/video devices you want to use with your television. To make these connections you will use plugs like the ones illustrated below.



## RF Connectors

Used to connect a coaxial cable from an external antenna or Cable TV system.



## A/V Input Plug

Used to connect audio/video devices like VCRs, DVD players, stereo amplifiers, game consoles, etc.



## S-Video Plug

Used to make video connections with VCRs, DVDs, Camcorders, etc (optional).



## AV Compu Link Cable

Used to connect JVC AV Compu Link capable components for an automated home theater.

We recommend that before you start using your new television, you read your entire User's Guide so you can learn about your new television's many great features. But if you're anxious to start using your television right away, a quick setup guide follows on the next three pages.

# Quick Setup 1

## Getting Started

These quick setup pages will provide you, in three easy steps, with the basic information you need to begin using your new television right away. This information includes basic instructions on operating your remote control, making a simple cable/antenna and optional VCR connection and, finally, information on programming your television's Auto Tuner.

If you have questions, or for more detailed information on any of these steps, please consult other sections of this manual.

## Step One - The Remote Control

The remote control is the key to operating your television's many great features. Before you can operate your remote control, you first need to install the batteries (included).

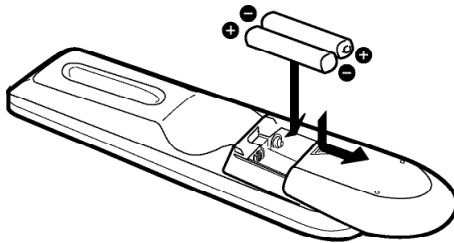

Slide the cover on the back of the remote down towards the bottom of the remote control. Insert two batteries (included) carefully noting the "+" and "-" markings, placing the "-" end in the unit first. Slide the cover back into place.

## Basic Operation

Turn the television on and off by pressing the POWER button at the top right corner of the remote.



**Power Button**

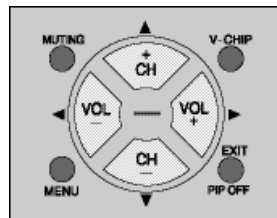

**Key Feature Buttons**

The four key feature buttons at the center of the remote can be used for basic operation of the television. The top and bottom buttons will scan forward and back through the available channels. The right and left buttons will turn the volume up or down. These buttons are also marked with four arrows and are also used with JVC's onscreen menu system. You will need to use these buttons later in the Quick Setup.

The next step is to connect your television to an antenna or cable.



# Quick Setup 2

## Step Two - Making Basic Connections

Next you will need to connect your television to an antenna or cable system. The most basic antenna/cable connection is shown below. For more detailed connections, such as ones where a cable box is required, see pages 11 to 13.

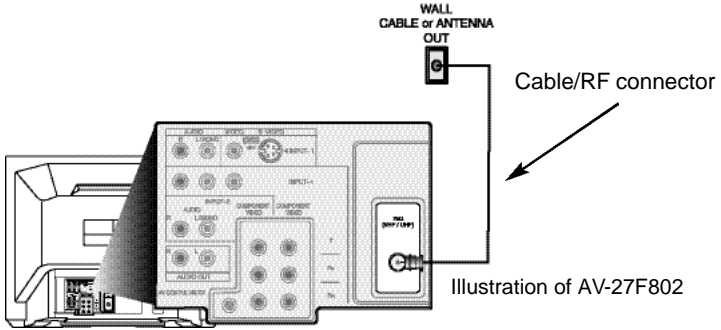

- 1) Connect an RF cable out from the wall outlet in to the RF Input on the back of the TV.

You may also wish to connect a VCR at this point. A basic VCR connection is shown below. For detailed instructions on connecting a other components or a home theater system, see pages 14 to 16.

**NOTE:** A VCR is not required to operate your television.

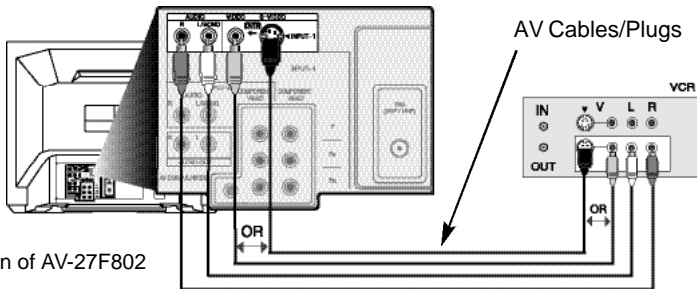

- 1) Connect the yellow video cable out from the VCR's Video Output, in to the TV's Video Input jack, **OR** connect an S-Video cable from the VCR's S-Video output, to the TV's S-Video input.
- 2) Connect the white audio cable out from the VCR's Left Audio Output, in to the TV's Left Audio Input Jack.
- 3) Connect the red audio cable out from the VCR's Right Audio Output, in to the TV's Right Audio Input jack.

Finally, once you have finished your connections, plug the power cord into the nearest power outlet and turn on the television.

Proceed to Step Three 

# Quick Setup 3

## Step Three - The Plug In Menu

When you turn your television on for the first time the Plug In Menu will appear. This menu sets some of the basic settings for your television. A complete description of the Plug In Menu can be found starting on page 22. We recommend you complete the Plug In Menu items before you start using your television. But to begin watching your television right away you only need to run the Auto Tuner Setup. This lets your television learn the channels it is able to receive. To run the Auto Tuner Setup follow the steps below.

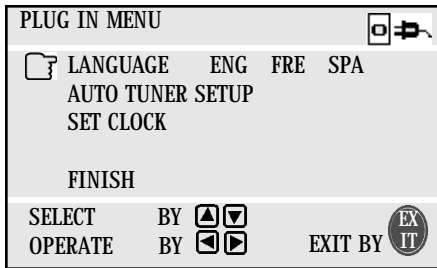

Press the ▲▼ buttons to move to AUTO TUNER SETUP

Press the ◀▶ buttons to begin AUTO TUNER SETUP

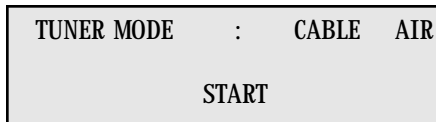

- ◀▶ To choose CABLE (if you are connected to a cable system) or AIR (if you use an antenna)
- ▲▼ To move to START
- ◀▶ To start Auto Tuner Setup

The Auto Tuner will now memorize all of the clear, active channels your television can receive. This will take one or two minutes.



The Auto Tuner is finished when the message PROGRAMMING OVER! appears onscreen. Your Quick Setup is now complete. You can now begin watching your television, or you can continue on in this guide for more information on connecting audio/video devices, programming your remote control, or using the JVC onscreen menu system to customize your television viewing experience.



The Quick Setup  
is complete

# Connections

## Cable and VCR Connections

There are three basic types of antenna or cable connections:

- If you have an antenna or have a cable system that does not require you use a cable box to select channels, please refer to **Diagram #1**.
- If you have a cable system that requires the use of a cable box to access all the channels, please refer to **Diagram #2**. If you cannot operate your Picture-In-Picture function using **Diagram #2**, try the connection shown in **Diagram #3**. It is possible your cable box allows the signal of only one channel at a time to be sent to your television.
- If you have a cable system that requires the use of a cable box to access certain premium channels, but not "basic" cable channels, please refer to **Diagram #3**.
- For your convenience, connection to a VCR is also shown in the following diagrams. A VCR is *not necessary for operation of the television or Picture-In-Picture (PIP) function*. You may omit the VCR from your connections if you wish.
- For instructions on connecting a VCR only, please see the Quick Setup on page 9.
- For information on using PIP, please see page 44.
- **The PIP feature is available on models AV-36F802, AV-32F802 and AV-27F802 only.**

Diagram #1

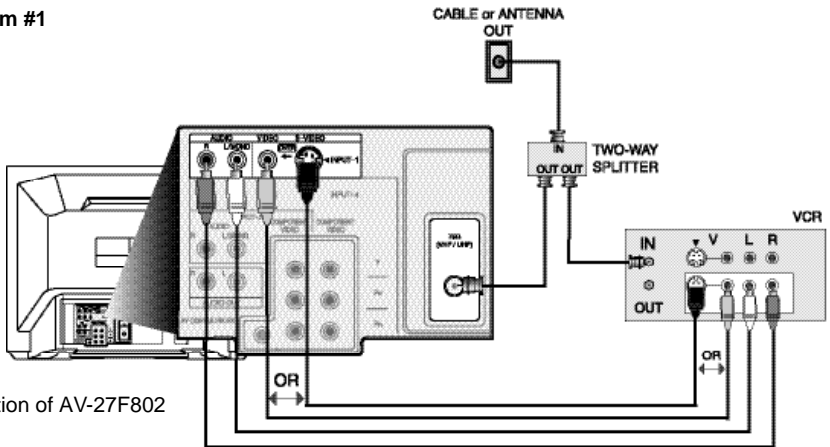

- 1) Connect the antenna or cable TV wire from the wall outlet, in to the RF Input of the two-way splitter.
  - 2) Connect an RF cable from the one of the RF Outputs on the splitter, in to the RF Input on the back of the VCR.
  - 3) Connect an RF cable from the other the RF Output on the splitter, in to the RF Input on the back of the TV.
  - 4) Connect the yellow video cable out from the VCR's Video Output, in to the TV's Video Input jack, **OR** connect an S-Video cable from the VCR's S-Video output, to the TV's S-Video input.
  - 5) Connect the white audio cable out from the VCR's Left Audio Output, in to the TV's Left Audio Input Jack.
  - 6) Connect the red audio cable out from the VCR's Right Audio Output, in to the TV's Right Audio Input jack.
- If your VCR is a mono sound unit, it will have only one Audio Out jack. Connect it to the TV's Left Audio Input.
  - Please consult your VCR's owner's manual for more information on its operation.

# Connections

## Cable and VCR Connections - Continued

Diagram #2

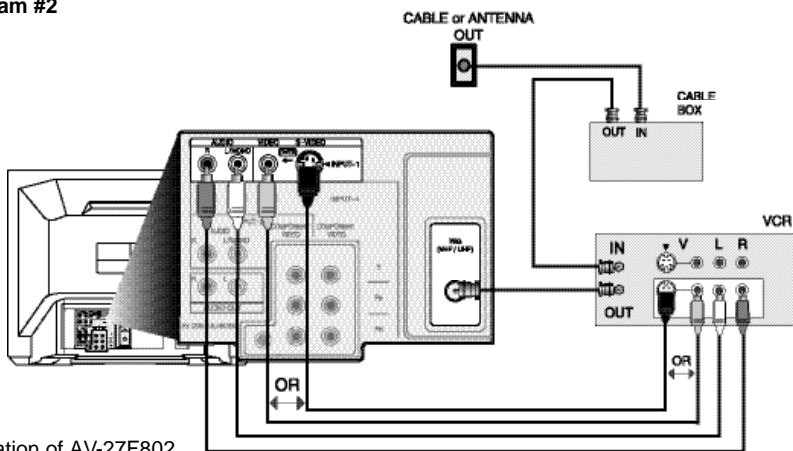

Illustration of AV-27F802

- 1) Connect the antenna or cable TV wire from the wall outlet, in to the RFInput of the cable box.
  - 2) Connect an RF cable from the RFOutput of the cable box, in to the RFInput on the back of the VCR.
  - 3) Connect an RF cable from the RF Output of the VCR, in to the RF Input on the back of the TV.
  - 4) Connect the yellow video cable out from the VCR's Video Output, in to the TV's Video Input jack, **OR** connect an S-Video cable from the VCR's S-Video output, to the TV's S-Video input.
  - 5) Connect the white audio cable out from the VCR's Left Audio Output, in to the TV's Left Audio Input Jack.
  - 6) Connect the red audio cable out from the VCR's Right Audio Output, in to the TV's Right Audio Input jack.
- Please see page 44 for information on using the PIP feature with a Cable Box.
  - If your VCR is a mono sound unit, it will have only one Audio Out jack. Connect it to the TV's Left Audio Input.
  - Please consult your VCR's owner's manual for more information on its operation.

# Connections

## Cable and VCR Connections - Continued

Diagram #3

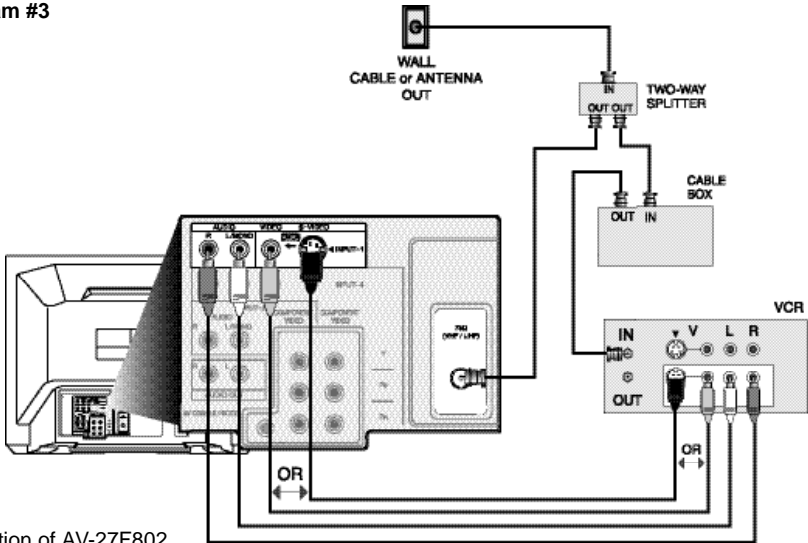

Illustration of AV-27F802

- 1) Connect the antenna or cable TV wire from the wall outlet, in to the RF Input of the two-way splitter.
  - 2) Connect an RF cable from the one of the RF Outputs on the splitter, in to the cable box RF Input.
  - 3) Connect an RF cable from the Cable Box Output, in to the VCR RF Input.
  - 4) Connect an RF cable from the other the RF Output on the splitter, in to the RF Input on the back of the TV.
  - 5) Connect the yellow video cable out from the VCR's Video Output, in to the TV's Video Input jack, **OR** connect an S-Video cable from the VCR's S-Video output, to the TV's S-Video input.
  - 6) Connect the white audio cable out from the VCR's Left Audio Output, in to the TV's Left Audio Input jack.
  - 7) Connect the red audio cable out from the VCR's Right Audio Output, in to the TV's Right Audio Input jack.
- Please see page 44 for information on using the PIP feature with a Cable Box.
  - If your VCR is a mono sound unit, it will have only one Audio Out jack. Connect it to the TV's Left Audio Input.
  - Please consult your VCR's owner's manual for more information on its operation.

The connection diagrams are intended to show some basic general connections. Some cable companies may require special connections to properly use your television or 2-tuner PIP function. If you follow these diagrams and either the television or PIP does not work properly, contact your local cable operator for more connection information. Please see page 44 for more information on the PIP feature.

# Connections

## Connecting to a DVD player

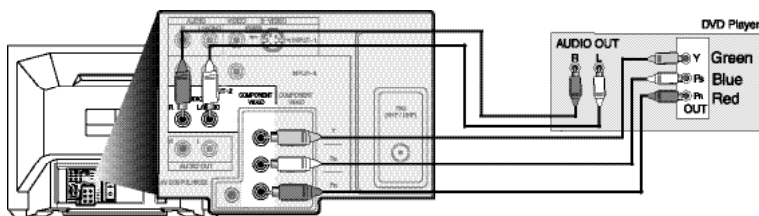

Illustration of AV-27F802

- 1) Connect Green cable out from DVD player “Y”Component Output, in to TV“Y” Component Input.
  - 2) Connect Blue cable out from DVDplayer “Pb” Component Output, in to TV “Pb” Component Input.
  - 3) Connect Red cable out from DVD Player “Pr” Component Output, in to TV “Pr” Component Input.
  - 4) Connect White Audio cable out from DVDLeft Audio Output, in to TV Left Audio Input 2.
  - 5) Connect Red Audio cable out from DVDRight Audio Output, in to TVRight Audio Input 2.
- Green, blue and red are the most common colors for DVD cables. Some models may vary colors. Please consult the user’s manual for your DVD Player for more information.
  - Be careful not to confuse the red DVD cable with the red audio cable. It is best to complete one set of connections (DVDor Audio Output) before starting the other to avoid accidentally switching the cables.
  - See page 20 for instructions on programming your remote control to operate the basic functions of your DVD player.
  - **AV-36F802, AV-32F802 & AV-27F802:** You may also connect the DVD player to Input 4. If you use Input 4 for the DVD connection, you must set the V4 COMPONENT-IN on the initial Setup Menu to “YES” for proper display of the DVD signal.
  - **AV-36F702, AV-32F702 & AV-27F702:** If you use Input 2 (Component-In) for the DVDconnection, you must set the V2 COMPONENT-IN on the initial Setup Menu to “YES” for proper display of the DVD signal.

**NOTE:** Progressive DVDPlayers (players with an output scan of 31.5 KHz) will not work properly with this television.

# Connections

## Connecting to an External Amplifier

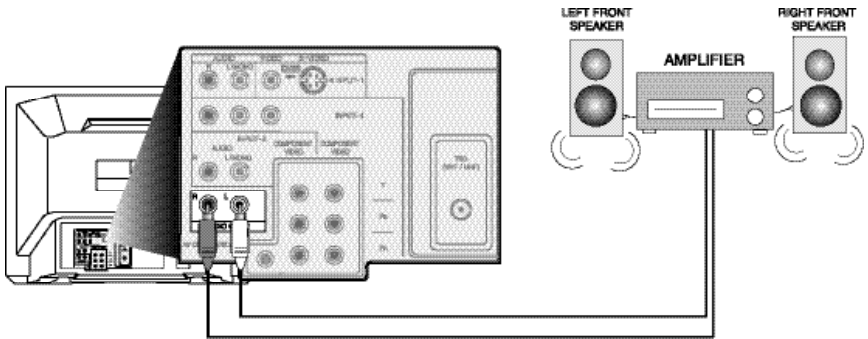

Illustration of AV-27F802

- 1) Connect the white audio cable from the TV's Left Audio Output jack to the Amplifier's Left Audio Input jack.
  - 2) Connect the red audio cable from the TV's Right Audio Output jack to the Amplifier's Right Audio Input jack.
- See also "TV Speaker" and "Audio Out" on page 38 for more information on using external speakers.

## Connecting to a Camcorder

You may connect a camcorder to your television by using the front Input Jacks (Input 3) located under the front panel door. To access, press lightly on the door to open it. You may also connect a game console or other equipment using these jacks. Camcorders may also be connected to the television's rear input jacks.

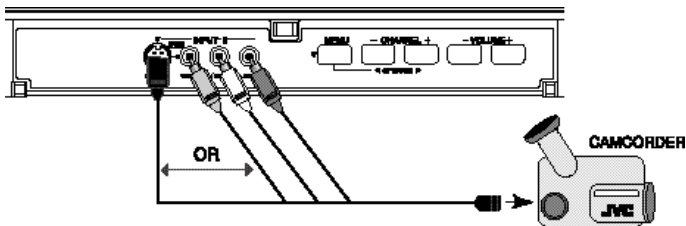

Illustration of AV-27F802

- 1) Connect the yellow video cable out from the Camcorder's Video Output, in to the TV's Video Input jack, **OR** connect an S-Video cable from the Camcorder's S-Video output, to the TV's S-Video Input.
  - 2) Connect the white audio cable out from the Camcorder's Left Audio Output, in to the TV's Left Audio Input jack.
  - 3) Connect the red audio cable out from the Camcorder's Right Audio Output, in to the TV's Right Audio Input jack.
- If your Camcorder is a mono sound model it will have only one audio jack. Connect it to the TV's Left Audio jack.

# Connections

## Connecting to JVC AV Compu Link

JVC's AV Compu Link feature makes playing video tapes or DVDs totally automatic. Simply insert a pre-recorded tape into your JVC-brand VCR or DVD into your JVC DVD player and the device will automatically turn on and begin playback. At the same time, using the AV Compu Link, the VCR or DVD player sends a signal to the television telling it to turn on and switch to the proper video input.

- The AV Compu Link cable may be included with the JVC AV Compu Link accessory you wish to connect. If it is not, contact an authorized JVCService Center for part # EWP 805-012.
- AV Compu Link can only be used with JVC-brand products.

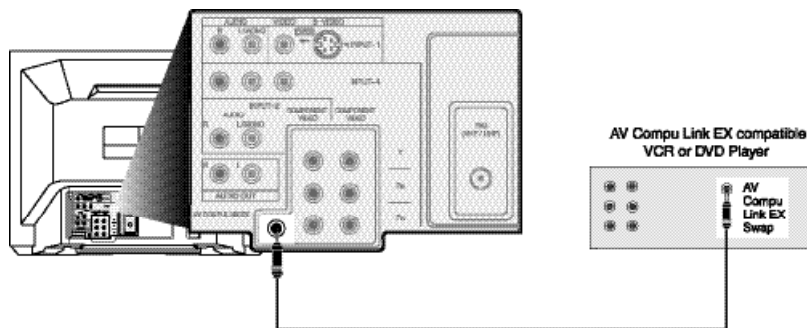

Illustration of AV-27F802

**To Connect:** Plug one end of the AV Compu Link cable into the AV Compu Link input on your VCR, DVD, or other Compu Link device. Plug the other end of the AV Compu Link cable into the AV Compu Link input at the rear of the television.

### NOTE:

- In order for the VCR playback to begin automatically, the recording tabs must be removed from the VHS tape. If the tab is in place, automatic switching will occur when you push the VCR's PLAY button.
- The AV Compu Link cable has a male 3.5 mm (mono) plug on each end.
- If your JVC-brand VCR has "A Code/B Code Remote Control Switching"(see your VCR's instruction book), using VCR A Code will switch the TV to input 1.
- To connect a JVC HiFi receiver or amplifier for a completely automated home theater, see the HiFi's connection instructions for detailed connection information.
- AV COMPU LINK EX is compatible with the following receivers:RX-664V, RX-665V, RX-668VBK, RX-774V, RX-778VBK, RX-884V, RX-888VBK, RX-1024V, RX-1028VBK, and later receiver models.



# Remote Control

## Remote Control Basics

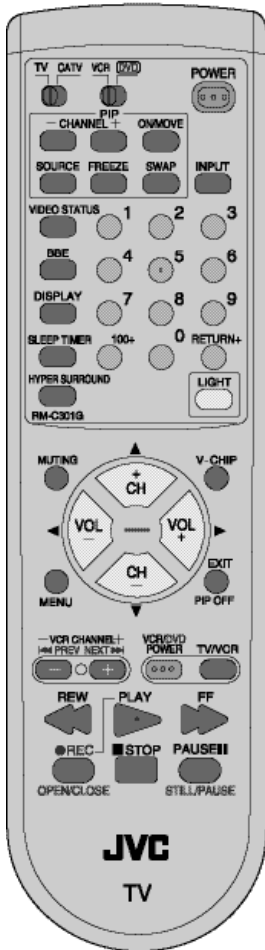

- Before you can operate the remote control, you must first install the batteries (included). See “Changing the Batteries” at the bottom of this page for instructions. (For an illustration, please see page 8.)
- Press the POWER button to turn the television on or off.
- Make sure the TV/CATV switch is set to TV. Move the switch to CATV only if you need to operate a cable box.
- Slide the VCR/DVD selector switch to VCR to control a VCR, slide to DVD to control a DVD player. Please see pages 18 to 20 for instructions on programming your remote control to operate a Cable box, VCR or DVD player.
- Press the CH+ and CH- buttons to scan through the channels. Tap the CH+ or CH- button to move through the channels one channel at a time.
- To move rapidly through the channels using JVC's **Hyperscan** feature, press and hold CH+ or CH-. The channels will zip by at a rate of five channels per second.
- Press VOL+ or VOL- to raise or lower the volume. An indicator bar will appear onscreen to show you the television volume level.
- The CH+/- and VOL+/- buttons are also used to navigate JVC's onscreen menu system.
- You can directly access specific channels using the 10-key pad.
- For more information on remote control button features, see pages 40 to 45. For information on using the onscreen menus, see page 21.

**NOTE:** Remote control model RM-C301G is shown at the left. A different model remote control may have come with your television.

## Changing the Batteries

Push down on the remote's back cover and slide towards the bottom to remove it.

Insert two AA batteries (supplied), carefully noting the "+" and "-" markings on the batteries and on the remote control. To avoid a potential short circuit, insert the "-" end first. Be sure to use only size AA batteries.

When batteries are installed, slide the cover back into place (until it clicks into position).

- If the remote control acts erratically, replace the batteries. Typical battery life is six months to one year. We recommend using alkaline batteries for longer battery life. When you change the batteries, try to complete the task within three minutes. If you take longer than three minutes, the remote control codes for your VCR, DVD, and/or Cable Box may have to be reset (see pages 18-20).

# Remote Programming

## Setting the CATV, VCR and DVD Codes

You can program your remote to operate your cable box, satellite receiver, VCR or DVD player by using the instructions and codes listed below. If the equipment does not respond to any of the codes listed below or to the code search function, use the remote control supplied by the manufacturer.

### Cable Box or Satellite codes

The remote control is programmed with CATV and/or Satellite codes for power on, power off, channel up, channel down, and 10 key operation.

- 1) Find the CATV/Satellite brand from the list of codes shown below.
  - 2) Slide the 2-way selector switch to "CATV".
  - 3) Press and hold down the DISPLAY button.
  - 4) With the DISPLAY button held down, enter the first code number listed using the 10 key pad.
  - 5) Release the DISPLAY button.
  - 6) Confirm the operation of the Cable Box/Satellite receiver.
- If your CATV or Satellite box does not respond to the first code, try the others listed. If it does not respond to any code, try the Search Codes Function, on page 50.

Cable Box	CODES	Cable Box	CODES	Digital Satellite Systems	CODES	
ABC	024	Puser	032			
Archer	032, 025	RCA	061, 070		Echostar	100, 113, 114
Cableview	051, 032	Realistic	032		Express VU	100, 113
Citizen	022, 051	Regal	058, 064, 040, 041, 042, 045, 068		G.E.	106
Curtis	058, 059	Regency	034		G.I.	108
Diamond	024, 032, 025	Rembrandt	037, 032, 051, 038		Gradiente	112
Eagle	029	Samsung	051		Hitachi	104, 111
Eastern	034	Scientific Atlanta	057, 058, 059		HNS (Hughes)	104
GC Brand	032, 051	SLMark	051, 047		Panasonic	105
Gemini	022, 043	Sprucer	051, 056		Philips	102, 103
General Instrument	065, 024, 025, 026, 027, 020, 021, 022, 057, 023	Stargate	032, 051		Primestar	108
Hamlin	040, 041, 042, 045, 058, 064	Telecaption	067		Proscan	106, 109, 110
Hitachi	049, 024	Televue	047, 051		RCA	106, 109, 110
Jerrold	065, 024, 025, 026, 027, 020, 021, 022, 057, 023	Texscan	044		Sony	107
Macom	049, 050, 051, 054	Tocom	035, 036, 068		Star Choice	104, 108
Magnavox	033	Toshiba	050		Toshiba	101
Memorex	030	Unika	032, 025		Uniden	102, 103
Movietime	032, 051	Universal	022, 032			
Oak	039, 037, 048	Videoway	052			
Panasonic	055, 056, 060, 071	Viewstar	029, 030			
Paragon	063	Zenith	063, 046			
Philips	028, 029, 030, 052, 053, 031, 069	Zenith/Drake Satellite	046			
Pioneer	047, 062					
Pulsar	051, 032					

# Remote Programming

## VCR codes

The remote control is programmed with VCR codes for power on, power off, play, stop, fast-forward, rewind, pause, record, channel up, and channel down operation.

- 1) Find the VCR brand from the list of codes shown below.
  - 2) Slide the first 2-way selector switch to "TV" and the other 2-way selector switch to "VCR".
  - 3) Press and hold down the DISPLAY button.
  - 4) With the DISPLAY button held down, enter the first code number listed with the 10 key pad.
  - 5) Release the DISPLAY button.
  - 6) Confirm the operation of the VCR.
- If your VCR does not respond to the first code, try the others listed. If it does not respond to any code, try the Search Codes Function, on page 50.
  - Some manufacturer's VCR's may not respond to the TV/VCR button, even if other buttons work properly.
  - To record, hold down the REC button on the remote and press PLAY.

VCRs	CODES	VCRs	CODES	VCRs	CODES
Admiral	035	Marantz	003, 004, 005	Samsung	037, 060, 062, 033, 089
Aiwa	027, 032, 095	Marta	064	Samtron	089
Akai	029, 072, 073, 074	Memorax	024, 067	Sansui	003, 026, 020, 052
Audio Dynamic	003, 005	MGA	038, 040, 047, 048, 041, 042	Sanyo	063, 067, 091, 071
Bell & Howell	063, 071	Minolta	058, 045, 093	Scott	059, 060, 062, 067, 038, 040, 047, 048, 026, 020
Broksonic	020, 026, 094	Mitsubishi	038, 040, 047, 048, 041, 042, 078, 090	Sears	063, 064, 065, 066, 058, 000, 001
Canon	023, 025	Multitech	047, 027, 062	Shintom	075
CCE	043	NEC	003, 004, 005, 000	Sharp	035, 036, 080, 088
Citizen	064	Olympic	024, 023	Signature 2000	027, 035
Craig	063, 029, 064	Optimus	028, 021, 035, 064	Singer	075
Curtis Mathes	045, 024, 027, 093	Orion	026, 020	Sony	028, 029, 030, 053, 054, 055
Daewoo	043, 059, 024, 092	Panasonic	023, 024, 021, 022	SV 2000	027
DBX	003, 004, 005	Penney	024, 058, 045, 063, 003, 004, 005, 093	Sylvania	031, 023, 024, 027
Dimensia	045, 093	Pentax	058, 005, 045, 093	Symphonic	027, 081
Emerson	043, 026, 077, 061, 025, 042, 020, 076	Philco	031, 024, 027, 023, 026, 020, 043	Tashiro	064
Fisher	063, 066, 067, 065, 071, 091	Philips	031, 023, 024, 086	Tatung	003, 004, 005
Funai	027, 026, 020, 000	Pioneer	023	Teac	003, 004, 027, 005
G.E.	033, 045, 024	Proscan	045, 058, 023, 024, 031, 046, 059, 060, 033, 087, 093	Technics	021, 022, 023, 024
Go Video	037, 051, 049, 050, 089	Quasar	021, 022, 023, 024	Teknika	024, 027, 070
Goldstar	064	Radio Shack	033, 024, 063, 036, 067, 040, 027	Toshiba	059, 046, 079
Gradiente	083, 064, 061, 000, 001	RCA	033, 045, 058, 023, 024, 031, 046, 059, 060, 063, 084, 085, 087, 093	Vector Research	005
Hitachi	023, 045, 058, 027, 061, 093	Realistic	024, 063, 036, 067, 040, 027	Wards	035, 036, 067, 044, 064
Instant Replay	024, 023			Yamaha	083, 003, 004, 005
Jensen	003			Zenith	044, 082, 064, 094
JVC	000, 001, 002, 003, 004, 005				
Kenwood	003, 004, 064, 005				
LXI	027, 064, 058, 065, 066, 063, 067				
Magnavox	031, 023, 024, 086				

# Remote Programming

---

## DVD codes

The remote control is programmed with DVD codes for power on, power off, play, stop, fast-forward, rewind, previous chapter, next chapter, tray open/close, and still/pause operation.

- 1) Find the DVD player brand from the list of codes shown below.
  - 2) Slide the first 2-way selector switch to "TV" and the other 2-way selector switch to "DVD".
  - 3) Press and hold down the DISPLAY button.
  - 4) With the DISPLAY button held down, enter the first code number listed with the 10 key pad.
  - 5) Release the DISPLAY button.
  - 6) Confirm the operation of the DVD player.
- If your DVD player does not respond to the first code, try the others listed. If it does not respond to any code, try the Search Codes Function, on page 50.
  - After you program your remote, some DVD buttons may not work properly. If some buttons do not work properly, use the remote control which came with your DVD player.

DVD Player	CODES	DVD Player	CODES
Aiwa	043	Raite	033
Apex	040	RCA	021, 026
Denon	020, 037	Sampo	034
Hitachi	030, 031	Samsung	030
JVC	000	Sharp	028
Kenwood	035	Sylvania	038
Konka	039	Sony	024, 045, 046, 047
Mitsubishi	025		
Onkyo	041	Technics	020
Oritron	044	Toshiba	023
Panasonic	020	Wave	042
Philips	023, 036	Yamaha	020
Pioneer	022	Zenith	027, 032

---

# Onscreen Menus

## Using the Guide

Certain symbols are used throughout this guide to help you learn about the features of your new television. The ones you will see most frequently are:

- ▲▼ Up and Down arrows mean press the CH+ or CH- buttons. Pressing the CH+ or CH- buttons let you:
  - Move vertically in a main menu screen
  - Move through a submenu screen
  - Move to the next letter, number, or other choice in a submenu
  - Back up to correct an error
  - Scan through TVchannels (when not in a menu screen)
- ◀▶ Left and right arrows mean press the VOLUME+ or VOLUME- buttons to move left or right to:
  - Select a highlighted menu item
  - Select an item in a submenu
  - Select numbers in certain menu options
  - Turn the volume up or down (when not in a menu screen)



The “Press Button” icon means you should press the button named on your remote control. (Button names appear in SMALL CAPITAL LETTERS.)



The “Helping Hand” icon points to the highlighted or selected item in a menu.

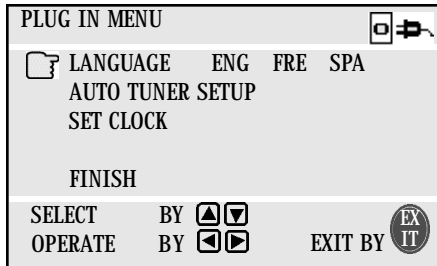

## The Onscreen Menus

**To bring up the onscreen menu**, press the MENU button on the remote control. The item that appears in yellow is the one currently selected. If you press the MENU button again, the onscreen display will skip to the next menu screen. If you use the Menu button on the TV's front panel instead of the remote, an additional menu screen showing channel number and input will appear. The “Plug In Menu” will appear the first time the TV is plugged in.

**NOTE:** Menus shown in this book are illustrations, not exact replications of the television's onscreen displays.

# Plug In Menu

---

## Introduction

The Plug In Menu comes up automatically when you first turn on the TV after plugging it in. The Plug In Menu helps you to get your TV ready to use by letting you set your preferences for:

- The Language in which you want the onscreen menus to appear,
- The Auto Tuner Setup of which channels you wish to receive,
- Setting the TV's clock to the correct time so your timer functions will work properly.

Descriptions of each of the Plug In Menu features appear on this page and the next. We recommend you complete the Plug In Menu setup first so your TV is set up just the way you want, right away.

## Language

You can choose to view your onscreen menus in three languages: English, French, or Spanish.



Press the MENU button



To LANGUAGE



To choose a language



- You will not need to press the MENU button to enter this screen from the Plug In Menu.

## Auto Tuner Setup

In Auto Tuner Setup, the TV automatically scans through all available channels, memorizing the active ones and skipping over blank ones or channels with weak signals. This means when you scan (using the CHANNEL +/- buttons) you will receive only clear, active channels.



Press the MENU button



To AUTO TUNER SETUP



To operate



To choose CABLE or AIR



To move to START



To start Auto Tuner Setup



*Programming will take approximately 1 to 2 minutes.*



- Noise Muting will not work during Auto Tuner Setup.
- You will not need to press the MENU button to enter this screen from the Plug In Menu.

## Auto Clock Set

Before you use any of your TV's timer functions, you must first set the clock. You may precisely set your clock using the XDS time signal broadcast by most Public Broadcasting stations. To set the clock using the XDS signal:



Enter the channel number of your local PBS station



Press MENU



To SETCLOCK



To operate



To AUTO

MODE	AUTO	MANUAL
TIME ZONE	EASTERN	
D.S.T.	ON	OFF
FINISH		



To TIME ZONE



To select your time zone

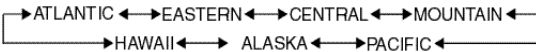

To move to Daylight Savings Time (D.S.T.)



To turn D.S.T. ON or OFF



To FINISH



To save settings and exit

- If you do not have a PBS station in your local area, you will have to set the clock manually. See 'Manual Clock Set' on the next page for instructions.
- The Daylight Savings Time feature automatically adjusts your TV's clock for Daylight Savings. The clock will move forward one hour at 2:00 am on the first Sunday in April. The clock will move back one hour at 2:00 am on the last Sunday in October.
- You will not need to press the MENU button to enter this screen from the Plug In Menu.

# Plug In Menu

---

## Manual Clock Set

To set your clock manually (without using the XDS signal), choose MANUAL from the Set Clock menu and follow the steps below.

- ▲▼ To SET CLOCK
- ◀▶ To operate
- ◀▶ To MANUAL

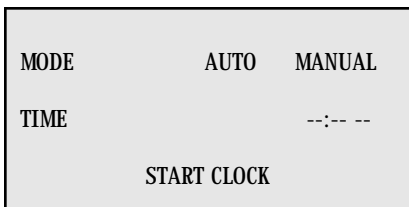

- ▲▼ To move to the hour
- ◀▶ To set the hour
- ▲▼ To move to minutes
- ◀▶ To set the minutes
- ▲▼ To move to START CLOCK
- ◀▶ To start clock and exit



- You will not need to press the MENU button to enter this screen from the Plug In Menu.

## Finish

Once you have the items in the Plug In Menu set to your personal preferences, move to the Finish option to save your settings.

- ▲▼ To FINISH
- ◀▶ To save settings and exit

- You can change the preferences you set in the Plug In Menu at any time using the regular JVC onscreen menu system.

### NOTE:

You will have to reset the clock after a power interruption. You must set the clock before operating any timer functions.



# Channel Summary

## Channel Summary

Channel Summary allows you to customize the line-up of channels received by your TV. You can add or delete channels from the line-up or prevent any unauthorized viewers from watching any or all 181 channels.



Press the MENU button



To CHANNEL SUMMARY



To operate

CHNO.	SCAN		CHNO.	SCAN	
01			06	✓	
02	✓		07		
03	✓		08		
04	✓		09	✓	
05	✓		10	✓	

The Channel Summary screen (above) will now be displayed with the channels set to scan marked with a "✓". You can delete channels from the scan by removing the "✓". If any channels were missed during Auto Tuner Setup and you wish to add them, you may by placing an "✓" next to the channel number.



To the SCAN column



To include or delete from scan



EXIT when finished

You can block access to a channel by activating the Channel Lock.



To CHANNELSUMMARY



To operate



To the Lock Column



ZERO to lock or unlock that channel



EXIT when finished

## Channel Guard Message

When a viewer attempts to watch a guarded channel, the following message appears:

THIS CHANNEL IS LOCKED BY  
CHANNEL GUARD.  
PLEASE ENTER LOCK CODE BY  
10 KEY PAD TO UNLOCK IT.  
NO. - - - -

To watch a channel that you have locked, enter the Lock Code using the 10 key pad. If the wrong code is entered, the message "INVALIDLOCK CODE!" will flash on the screen:

The channel cannot be accessed until the correct code is entered.

- Once a channel has been unlocked, it will remain unlocked until the television is turned off.
- See also "Set Lock Code", page 33.

# V-Chip

---

Your TV is equipped with V-Chip technology which enables TV Parental Guidelines (for United States and Canada) and Movie (MPAA) Guideline controls. V-Chip technology allows you to program your TV to receive, or not to receive, programs based on content according to the guidelines. Programs which exceed the ratings limits you set will be blocked. When a viewer attempts to watch a blocked channel, this message appears:

THIS PROGRAMMING EXCEEDS  
YOUR RATING LIMITS.  
PLEASE ENTER LOCK CODE BY  
10 KEY PAD TO UNLOCK IT.  
NO. - - - -

The channel will remain blocked until the correct lock code is entered (see page 33 for information on setting your lock code).

You can customize the V-Chip settings of your television to match your personal tastes. The V-Chip menu below is the starting point for your V-Chip settings.

V-CHIP ON OFF  
SET US TV RATINGS  
SET MOVIE RATINGS  
SET CANADIAN RATINGS ENG  
SET CANADIAN RATINGS FRE  
UNRATED VIEW BLOCK  
  
FINISH

You can use US V-Chip settings (for programming broadcast from the United States), Canadian V-Chip settings (for programming broadcast from Canada), and movie ratings. You may use any or all of the settings (US V-Chip, Canada V-Chip, Movie ratings). Descriptions for setting each of the three V-Chip formats appear in the next seven pages along with descriptions of the rating categories.

To access the rating categories:



Press the MENU button



To V-CHIP



To operate (Lock icon  will appear)



Press ZERO to access the V-Chip menu



To turn V-Chip ON or OFF (V-Chip must be turned ON for rating settings to operate)



To move to SET US TV RATINGS, SETMOVIE RATINGS, or SET CANADIAN RATINGS (see following pages for descriptions of each item)

## Special Note about Ratings

Some programs are not broadcast with a ratings signal. Therefore, even if you setup V-Chip ratings limits, these programs will not be blocked. Parents are cautioned to preview the contents of these programs or movies.

## US V-Chip Ratings

### U.S. PARENTAL RATING SYSTEMS

Programs with the following ratings are appropriate for children.

**TV Y is Appropriate for All Children.**

Programs are created for very young viewers and should be suitable for all ages, including children ages 2 - 6.

**TV Y7 is for Older Children.**

Most parents would find such programs suitable for children 7 and above. These programs may contain some mild fantasy violence or comedic violence, which children should be able to discern from reality.

Programs with the following ratings are designed for the entire audience.

**TV G stands for General Audience.**

Most parents would find these programs suitable for all age groups. They contain little or no violence, no strong language, and little or no sexual dialog or situations.

**TV PG Parental Guidance Suggested.**

May contain some, but not much, strong language, limited violence, and some suggestive sexual dialog or situations. It is recommended that parents watch these programs first, or with their children.

**TV 14 Parents Strongly Cautioned.**

Programs contain some material that may be unsuitable for children under the age of 14 including possible intense violence, sexual situations, strong coarse language, or intensely suggestive dialog. Parents are cautioned against unattended viewing by children under 14.

**TV MA Mature Audiences Only.**

These programs are specifically for adults and may be unsuitable for anyone under 17 years of age. TV MA programs may have extensive V, S, L, or D.

### Viewing Guidelines

In addition to the ratings categories explained above, information on specific kinds of content are also supplied with the V-Chip rating. These types of content may also be blocked. The content types are:

- **V/FV** is for VIOLENCE/FANTASY VIOLENCE
- **S** stands for SEXUALCONTENT
- **L** stands for strong LANGUAGE
- **D** stands for suggestive DIALOG

# V-Chip

---

## Setting US V-Chip Ratings



Press the MENU button



To V-CHIP



To operate (Lock icon  will appear)



Press ZERO to access the V-Chip menu



To turn V-Chip ON or OFF







To move to SET US TV RATINGS



To operate

## Directions to set US V-Chip Ratings:

Line up the cursor in the column (TV PG, TV G, etc.) with the content row (V/FV, S, etc.) and press the  or  to move the cursor to the correct location. Press  or  to turn the locking feature on or off. An item is locked if the  icon appears instead of a “—”.

**For example:** To block viewing of all TV 14 shows, move the cursor to the top row of that column and add a lock icon. Once you've put a lock on the top row, everything in that column is automatically locked.



To the TV 14 Column



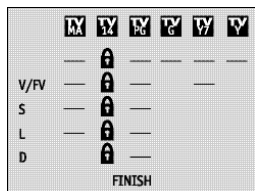

To turn on the lock



To FINISH



To save settings and exit

- If you want to change the setup, move the cursor to the top column and change the lock icon to “—” by pressing  or  again. You may then select individual categories to block.

## Setting ratings with the V-Chip button

To access Rating information about a certain program, press the V-CHIP button while viewing that program. A display like this will appear:



If you decide you want to block this category of viewing, press "0" while the above screen is visible, and all programs from that category will be blocked.

### Example 1:

If you want to set your V-Chip settings to block all programming above TV PG:



Press ZERO when TV-PG is displayed

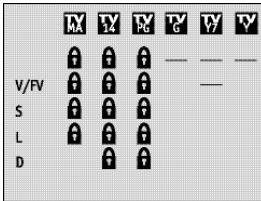

All Programming above TV PG will be blocked.

### Example 2:

If you want to set your V-Chip settings to block all programming above a current setting such as TV PG-V (with violence):



Press ZERO when TV-PG - V is displayed

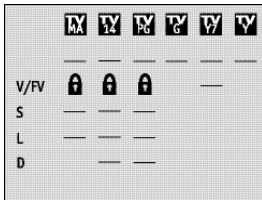

All Programming above TV PG - V (with Violence) will be blocked.

- For Children's programming you can block TV-Y and Y7 programs by Pressing "0" when Y is displayed during a program. Programming for audiences other than children's audiences will not be affected.

# V-Chip

---

## Movie Ratings

### NR – Not Rated.

This is a film which has no rating. In many cases these films were imported from countries which do not use the MPAA ratings system. Other NR films may be from amateur producers who didn't intend to have their film widely released.

*NR (Not Rated) Programming may contain all types of programming including children's programming, foreign programs, or adult material.*

### G – General Audience.

In the opinion of the review board, these films contain nothing in the way of sexual content, violence, or language that would be unsuitable for audiences of any age.

### PG – Parental Guidance.

Parental Guidance means the movie may contain some contents such as mild violence, some brief nudity, and strong language. The contents are not deemed intense.

### PG-13 – Parents Strongly Cautioned.

Parents with children under 13 are cautioned that the content of movies with this rating may include more explicit sexual, language, and violence content than movies rated PG.

### R - Restricted.

These films contain material that is explicit in nature and is not recommended for unsupervised children under the age of 17.

### NC-17 - No One Under 17.

These movies contain content which most parents would feel is too adult for their children to view. Content can consist of strong language, nudity, violence, and suggestive or explicit subject matter.

### X - No One under 18.

Inappropriate material for anyone under 18.

## Directions to set Movie (MPAA) Ratings:



Press the MENU button



To V-CHIP



To operate (Lock icon  appears)



Press ZERO to access V-Chip setup options



To SET MOVIE RATINGS



To enter movies menu

**For example**, to block viewing of X and NC-17 rated from shows:



To the X Column



To turn on the lock

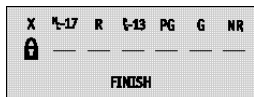

To the NC-17 Column



To turn on the lock



To FINISH



To save settings and exit

## Canadian V-Chip Ratings

- ❑ **E – Exempt.**  
Exempt programming includes: news, sports, documentaries and other information programming, talk shows, music videos, and variety programming.
- ❑ **C – Programming Intended for Children.**  
Violence Guidelines: There will be no realistic scenes of violence. Depictions of aggressive behavior will be infrequent and limited to portrayals that are clearly imaginary, comedic or unrealistic in nature.
- ❑ **C8+ – Programming Intended for Children 8 and Over.**  
Violence Guidelines: Any realistic depictions of violence will be infrequent, discreet, of low intensity and will show the consequences of the acts. There will be no offensive language, nudity or sexual content.
- ❑ **G – General Audience.**  
Programming will contain little violence and will be sensitive to themes which could affect younger children.
- ❑ **PG - Parental Guidance.**  
Programming intended for a general audience, but which may not be suitable for younger children. Parents may consider some content not appropriate for children aged 8-13.
- ❑ **14+ - 14 Years and Older.**  
Parents are strongly cautioned to exercise discretion in permitting viewing by pre-teens and early teens. Programming may contain mature themes and scenes of intense violence.
- ❑ **18+ - Adult.**  
Material intended for mature audiences only.

## Directions to set Canadian V-Chip Ratings:



Press the MENU button



To V-CHIP



To operate (Lock icon  appears)



Press ZERO to access V-Chip setup options



To SET CANADIAN RATINGS ENG (for English)



To enter ratings menu

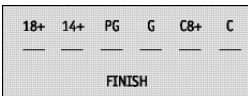

**For example**, to block viewing of programming rated 14+ and 18+:



To the 18+ Column



To turn on the lock



To the 14+ Column



To turn on the lock



To FINISH



To save settings and exit

- For instructions on “Set Canadian Ratings FRE (in French)”, please see page 31 in the French side of this user’s guide.

# V-Chip

---

## Unrated Programs

### Notes About Unrated Programs:

Unrated programming refers to any programming which does not contain a rating signal. Programming on television stations which do not broadcast rating signals will be placed in the "Unrated Programming" category.

### Examples of Unrated programs:

- Emergency Bulletins
- Locally Originated Programming
- News
- Political Programs
- Public Service Announcements
- Religious Programs
- Sports
- Weather
- Some Commercials

- TV programs or movies that do not have rating signals will be blocked if the Unrated Category is set to BLOCK.

### Directions to Block Unrated Programs:

You can block programs that are not rated.



Press the MENU button



To V-CHIP



To operate (The lock icon  appears)



Press ZERO to access V-Chip setup options



To UNRATED



To VIEW or BLOCK



Press EXIT when done



## Set Lock Code

Channel Guard and V-Chip settings are protected by a four-digit Lock Code. Your TV comes pre-set with a Lock Code of "0000". You may change the code to any four-digit number you wish. To change the Lock Code, follow the steps below.



Press the MENU button



To SETLOCK CODE



To operate

The lock icon  appears.



Press ZERO to access the Lock Code



The first digit will be highlighted



To select the number



To move to the next digit

Continue to follow these directions for all four numbers.



To FINISH



To save settings and exit

Your Lock Code is now set..

### NOTE:

- After a power interruption you must reset the Lock Code.
- Write your Lock Code number down and keep it hidden from potential viewers.
- If you forget the Lock Code, a new code may be set using the steps listed above.

# Picture Settings

---

## Tint

Tint allows you to adjust the levels of red and green in your TV picture.



Press the MENU button



To TINT



To increase the levels of green



To increase the levels of red



To move to the next setting

## Color

The color function lets you make all the colors in the TV picture appear either more vivid or subtle.



Press the MENU button



To COLOR



To make the colors more vivid



To make the colors more subdued



To move to the next setting

## Picture

Picture allows you to adjust the levels of black and white on the TV screen, giving you a darker or brighter picture overall.



Press the MENU button



To PICTURE



To increase the level of contrast



To decrease the level of contrast



To move to the next setting

## Bright

You can adjust the overall brightness of the TV picture with the Bright control.



Press the MENU button



To BRIGHT



To lighten the picture



To darken the picture



To move to the next setting

## Detail

The Detail feature adjusts the level of fine detail displayed in the picture.



Press the MENU button



To DETAIL



To make the picture sharper (more details)



To make the picture smoother (less detail)



To move to the next setting

---

# Picture Settings

## Noise Muting

This feature inserts a blank blue screen over channels which are not broadcasting or are too weak to be received clearly.



Press the MENU button



To NOISE MUTING



To turn Noise Muting ON or OFF

- Noise Muting will not work during Auto Tuner Setup or when you operate Channel Summary.

## Set Video Status

With Set Video Status, you can save your own set of picture quality adjustments as “Choice” and have access to them at the touch of a button.



Press the MENU button



To SETVIDEO STATUS



To operate

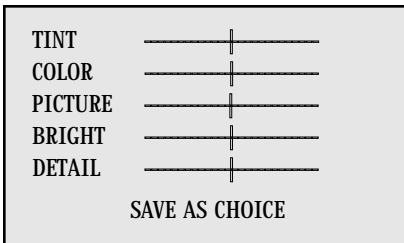

To set the TINT levels



To move to the next option

Repeat these steps until all levels are set.



To SAVEAS CHOICE



To save settings and exit

- You must use SAVE AS CHOICE to exit the Set Video Status menu, otherwise your preferences will not be saved.
- You can access your “Choice” settings at any time by pressing the VIDEO STATUS button on the remote control.

### NOTE:

The setting screen will disappear if you do not make any adjustments or move to the next setting in approximately three seconds. Any changes you have made to picture settings up to that point will be stored. You can exit the Picture Settings menu at any time by pressing the EXIT button on the remote control.

# Sound Settings

---

## Bass

You can increase or decrease the level of low-frequency sound in the TV's audio with the Bass adjustment.



Press the MENU button



To BASS



To increase the bass



To decrease the bass



To move to the next setting

## Treble

Use Treble to adjust the level of high-frequency sound in your TV's audio.



Press the MENU button



To TREBLE



To increase the treble



To decrease the treble



To move to the next setting

## Balance

Adjust the level of sound between the TV's two speakers with the Balance setting.



Press the MENU button



To BALANCE



To shift the balance towards the right speaker



To shift the balance towards the left speaker



To move to the next setting

## MTS (Multi-Channel Television Sound)

MTS technology allows several audio signals to be broadcast at once, giving you a choice in what you wish to hear with a TV program. In addition to mono or stereo sound, an MTS broadcast may also include a Second Audio Program (SAP).



Press the MENU button



To MTS



Select the mode

(The ON AIR arrow tells you if a broadcast is in Stereo and/or contains an SAP).

- Keep the TV in STEREO mode to get the best sound quality. The sound will work in STEREO mode even if a certain broadcast is in MONO sound only.
- Choose the MONO setting to reduce excessive noise on a certain channel or broadcast.
- Selecting SAP will allow you to hear an alternative soundtrack, if one is available.

### NOTE:

You can leave the Sound Settings menu at any time by pressing the EXIT button on the remote control.

## Purity

This helps clean up the picture so that it may not contain any "snow".



Press the MENU button



To PURITY



To enter



To adjust purity

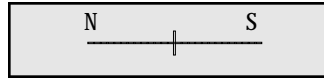

## On/Off Timer

The On/Off timer lets you program your television to turn itself on or off. You can use it as an alarm to wake up, to help you remember important programs, or as a decoy when you're not home.



Press the MENU button



To ON/OFFTIMER



To operate (begins with ON TIME)



To set the hour (AM/PM) you want the TV to turn on



To move to minutes



To set the minutes



To accept ON TIME and move to OFF TIME (the time the TV will turn off). Set the OFF TIME the same way as ON TIME



To accept OFFTIME and move to CHANNEL



To select channel



To move to MODE



Choose ONCE or EVERYDAY



To ON/OFFTIMER



Choose YES to accept the timer setting, choose NO if you don't wish to accept



To FINISH



To save settings

## On/Off Timer Note for PIP (AV-36F802, AV-32F802 & AV-27F802) only.

If the television is on when a timed event is about to start a Timer Preview window will appear. The Timer Preview window will appear in the lower right corner of the screen seven seconds before the timer is programmed to begin. When the timer activates, the Preview picture will become the main picture.

### NOTE:

- The On/Off time cannot be set to locked or guarded channels.
- In order for the On/Off timer to work, the clock must be set.
- After a power interruption, the Timer settings must be reset.

# General Items

---

## TV Speaker

If your TV is connected to a stereo system, you can turn off the TV speakers and listen to the audio through your stereo.



Press the MENU button



To TVSPEAKER



To turn the TV's speakers ON or OFF



EXIT when finished

- Before you turn the TV Speaker setting from OFF to ON, **make sure that the TV volume level is low!** If the TV volume is set too high, the sound level will be extremely loud.
- After a power interruption, the TVSpeaker settings will return to "ON".

## Audio Out

If your television is connected to an external speaker source, Audio Out gives you the option of controlling the volume level with your TV's remote control.



Press the MENU button



To AUDIO OUT

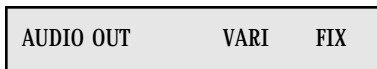

To VARI or FIX



EXIT when finished

**VARI:** Lets you adjust the volume of the external speakers using the VOLUME +/- buttons on your TV's remote control.

**FIX:** The volume of the external speakers is adjusted using the audio device's remote control.

### NOTE:

- External Speakers: When using external speakers or amplifiers, shut off the TV Speakers (see 'TV Speaker') above.

# General Items

## V4 Component-In (AV-36F802, AV-32F802 & AV-27F802) / V2 Component-In (AV-36F702, AV-32F702 & AV-27F702)

Get the best quality video from your DVD player by using this setting and the DVD inputs at the rear of the television. Set either to YES for component input (for DVD) or to NO for composite video input (for a regular VCR).



Press the MENU button



To V4 COMPONENT-IN (or V2 COMPONENT-IN for models AV-36F702, AV-32F702 and AV-27F702)

V4 COMPONENT-IN	YES	NO
-----------------	-----	----



To turn the input ON or OFF



EXIT when finished

- This option should be used with DVD players only. For information on connecting VCR's see page 11. For more information on connecting a DVD player, see page 14.
- **AV-36F702, AV-32F702 & AV-27F702 note:** These models do not have Input 4.

## Closed Caption

Many broadcasts now include an onscreen display of dialog called Closed Captions. Some broadcasts may also include displays of additional information in text form. Your television can access and display this information using the Closed Caption feature. To activate the Closed Caption feature, follow the steps below.



Press the MENU button



To CLOSED CAPTION



To operate

MODE	:	CAPTION
CAPTION	:	CC1 CC2 CC3 CC4
TEXT	:	T1 T2 T3 T4

FINISH



To select CAPTION (for Closed Captions), TEXT (for text display), or OFF (for no display)



To move to CAPTION or TEXT



To select a caption (CC1 to CC4) or text channel (T1 to T4)



To accept that selection and move to FINISH



To save settings and exit

### NOTE:

- Closed Caption subtitles are usually found on closed caption channel CC1. Some programs may include additional text information which is usually found on text channel T1. The other channels are available for future use.
- Closed captioning may not work correctly if the signal being received is weak or if you are playing a video tape.
- Most broadcasts containing Closed Captioning will display a notice at the start of the program.

# Button Functions

---

## Menu

The MENU button allows you to access JVC's onscreen menu system. Press MENU to activate the onscreen menu system.

- See individual topics (like "Sound Settings") for specific information on using menus.

## Exit and PIP Off

Press the EXIT button to leave a menu screen. On the RM-C301G this button is also labeled "PIP OFF". Press EXIT/PIP OFF to turn off the Picture-in-Picture function (please see page 44 for more information on the PIP feature).

- PIP is available only on AV-36F802, AV-32F802 & AV-27F802.

## Display

The Display screen shows the current status of timers and inputs.



Press the DISPLAY button

07	
NOW	12:20 PM
SLEEP TIMER	OFF
ON/OFF TIMER	EVERYDAY
ON TIME	7:00 PM
OFF TIME	10:00 PM

The screen above shows the following information:

- The current channel or AV input (Channel 07)
- The current time (12:20 pm)
- Sleep Timer status/minutes remaining (The Sleep Timer is off)
- On/Off Timer status (Set to turn on everyday at 7:00 PM, off at 10:00 PM)
- Each Press of the DISPLAY button changes the display mode:



**Display** – Full screen shown above

**Time** – Shows the current time only

**Channel** – Shows the current channel

**Off** – Turns Display off

- You may also turn off the Display at any step by pressing EXIT.

### NOTE:

- Please note that if the Clock, Sleep Timer or On/Off Timer are not set, the Display screen will show: "CLOCK NOT SET", "SLEEP TIMER OFF", and "ON/OFF TIMER OFF" respectively.



---

# Button Functions

## Video Status

The VIDEO STATUS button gives you a choice of three TV picture display settings, including a display of your own preferences.

**Standard** – Resets the picture display to the factory settings.

**Choice** – Displays the setting levels you specified on the "Set Video Status" Menu (see page 35).

**Theater** – Gives a rich, film-like look to video.



Press the VIDEO STATUS button



## Sleep Timer

The Sleep Timer can turn the TV off for you after you fall asleep. Program it to work in intervals of 15 minutes, for a total time of up to 180 minutes.



Press the SLEEP TIMER button

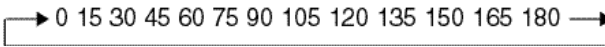

### Sleep Timer Message

20 seconds before the automatic shutoff, this message will appear:

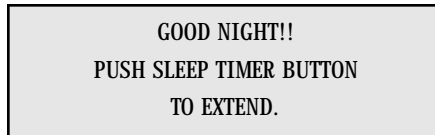

You then have 20 seconds to press the Sleep Timer button to delay the shutoff for another 15 minutes.

## Hyper Surround

Creates a deep, three-dimensional sound effect by channeling the audio through the TV's front-firing speakers. Press the HYPER SURROUND button to turn the effect on or off.



## Muting

The MUTING button instantly turns the volume down completely when you press it. Press MUTING and the volume level will instantly go to zero. To restore the volume to its previous level, press MUTING again.

# Button Functions

---

## BBE

BBE high definition audio adds natural, clear and extraordinary sound quality to any program. Turn BBE On or Off using the BBE button.



## 100+ Button

Use the 100+ button to directly access channels above Channel 99. For example to move to channel 124, press 100+, 2 (two), 4 (four).

## Return+

The RETURN+ button has two functions:

**Return** – Returns to the channel viewed just before the channel currently onscreen.

**Return+** – Lets you program a specific channel to return to while scanning through the channels using the CH+ and CH– buttons.



RETURN+ and hold for three seconds



The channel currently active has been programmed as your Return+ channel. Now scan through the channels using the CHANNEL+/- buttons



RETURN+

You will return to your programmed channel.

- To cancel your Return+ channel, press and hold the RETURN+ button for three seconds. The message "RETURN CHANNEL CANCELLED!" will appear.
- Return+ works only with the CHANNEL+/- buttons. Pressing any number key will cancel Return+.
- Return+ does not affect the PIPchannel (AV-36F802, AV-32F802 & AV-27F802 only).

## Input

Selects the signal input source for the television: TV (for Antenna or Cable) or Video-1, 2, 3, or 4 for video devices like VCR's, DVD players, or camcorders.



INPUT

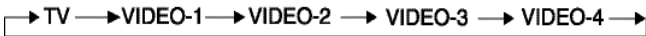

- AV-36F702, AV-32F702 & AV-27F702 do not have a Video-4 input.

### NOTE:

- BBE is a registered trademark of BBESound, Inc. For U.S., licensed from BBE Sound, Inc. under USP 4638258, 4482866 and 5510572. For Canada, licensed from BBE Sound, Inc. BBE is a registered trademark of BBESound, Inc.

---

# Button Functions

## VCR Buttons

You can use this remote control to operate the basic functions of your VCR. These functions include: play, record, rewind, fast-forward, stop, pause, channel scan, TV/VCR, power on, and power off.

Move the selector switch to **VCR** to operate.

- The remote is preset with the code 000 to control JVC-brand VCR's. For any other manufacturer's brand VCR, please see the code chart and instructions on page 19.

## DVD Buttons

You can also use this remote control to operate the basic functions of your DVD player. These functions include: play, rewind, fast-forward, stop, still/pause, previous/next, tray open/close, power on, and power off.

Move the selector switch to **DVD** to operate.

- The remote is preset with the code 000 to control JVC-brand DVD players. For any other manufacturer's brand DVD player, please see the code chart and instructions on page 20.

## TV/CATV Switch

Use either the television's own tuner or a cable box to select channels. Set this switch to TV to operate the television's built-in tuner. Move the switch to CATV to operate a cable box.

- See page 18 for information on programming your remote for cable box operation.

## VCR/DVD Switch

You can control a VCR or DVD player with the buttons on the lower part of the remote control. Use the VCR/DVD selector switch to choose either VCR or DVD operation.

- See pages 19 and 20 for information on programming your remote with VCR and DVD operating codes.

## Light

Your remote control includes illuminated buttons for key features like CHANNEL +/- and VOLUME +/- . Press the LIGHT button to turn the illumination on.

# Button Functions - PIP

---

PIP displays two separate pictures on screen. Your television has 2-Tuner PIP, meaning you can view pictures from two different channels simultaneously. A special set of PIP control buttons are located on the upper part of the remote control. Descriptions of each button appear on this page.

**The PIP feature is available on models AV-36F802, AV-32F802 & AV-27F802 only.**

## Cable Box Note

The 2-Tuner PIP function may not operate when used with certain cable boxes. This is because while some models of cable box may receive up to 181 channels, they may only send the signal from one channel to your television (please also see diagram on page 11). For the PIPtuner to operate correctly, it must have access to all available channels. Since the television is receiving the signal of only one channel from the cable box, it is impossible for the 2-Tuner PIP to display a second, different channel.

Because there are many different models of cable boxes in use today, if you are having problems operating your PIP feature with your cable box, we recommend you contact your local cable company for connection advice.

## On/Move

Turn PIP on by pressing the ON/MOVE button.



(PIP) ON/MOVE

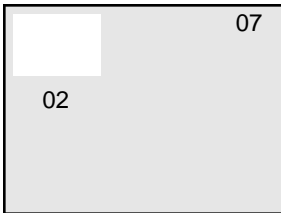

PIP OFF to turn PIP off

Once PIP is turned on, you can move the PIP window to any of the TV's main picture's four corners with the ON/MOVE button



ON/MOVE

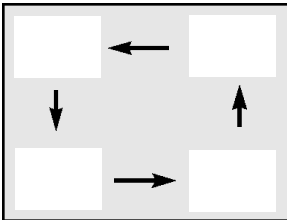

### NOTE:

- Each press of ON/MOVE will shift the PIP window to a different corner.

---

# Button Functions - PIP

## Freeze

Use the FREEZE button to lock a single, still image onto the PIP window.

- If PIP is off when FREEZE is pressed, a snapshot of the main screen is taken and placed in the PIP window.
- If PIP is on when FREEZE is pressed, the image in the window when the button was pressed is held.

## Swap

You can exchange the channel displayed on the main screen for the one shown in the PIP window by pressing SWAP.

## Channel +/- for PIP

Like the main CHANNEL +/- buttons, CHANNEL +/- for PIP lets you scan through the channels in the PIP window.

- Direct channel selection with the 10 key pad for PIP is not possible.

## Source

You can select the signal source for the PIP window image.

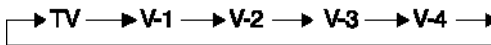

- If the PIP does not have a signal, the window will be blue.
- If you connect a DVD to Video-2 or Video-4, the PIP window will be blue.

### NOTE:

- The PIP window is  $\frac{1}{9}$  the size of the full screen.
- PIP will not display blocked channels or programs. A blue screen will display instead.

# Troubleshooting

PROBLEMS	CHECK
There is no power	<ul style="list-style-type: none"><li>• See if the power cord became unplugged.</li><li>• Check for a blown fuse or circuit breaker or a power outage.</li></ul>
There is no picture or sound	<ul style="list-style-type: none"><li>• The antenna could be disconnected.</li><li>• The input mode could be set improperly. See page 42.</li><li>• The tuner (Auto Tuner Setup) could be set improperly. See page 22.</li><li>• The TV station may be having difficulties. Check to see if other stations are working.</li></ul>
Remote control is not operating properly or at all	<ul style="list-style-type: none"><li>• Check to see that the batteries are still working and properly installed.</li><li>• Make sure the remote has a clear sight path to the TV.</li><li>• Check that the TV/CATV switch is in the proper position.</li><li>• You may be too far from the TV. You must be within 23 feet (7 meters).</li></ul>
You cannot select a certain channel	<ul style="list-style-type: none"><li>• Make sure the channels have been programmed. See "Channel Summary", page 25.</li><li>• Check to see if the channel is locked. See "Channel Summary - Lock" page 25.</li></ul>
The power turns off by itself	<ul style="list-style-type: none"><li>• Make sure the set did not become unplugged.</li><li>• Perhaps the On/Off Timer is set. See page 37.</li><li>• Check to see if the Sleep Timer was set. See page 41.</li></ul>
The clock is wrong	<ul style="list-style-type: none"><li>• The power was interrupted and the clock was not reset. See page 23.</li></ul>
The On Timer is blinking	<ul style="list-style-type: none"><li>• There is a problem with the TV. Unplug the set and call for service.</li></ul>
The color quality is poor	<ul style="list-style-type: none"><li>• Tint and Color may be improperly adjusted. See page 34.</li><li>• The Video Status mode may be turned to the wrong setting. See page 35.</li></ul>
There are lines across the picture	<ul style="list-style-type: none"><li>• There could be interference from another electrical appliance, such as a computer, another TV or VCR. Move any such appliances further away from the TV.</li></ul>
The picture is spotted	<ul style="list-style-type: none"><li>• There could be interference from a high-wattage appliance, like a hairdryer or vacuum, operating nearby. Move the antenna away from the appliance or change to a coaxial cable connection which is less prone to interference.</li></ul>
There are double pictures (ghosts)	<ul style="list-style-type: none"><li>• A building or passing airplane can reflect the original signal and produce a second, slightly delayed one. Adjust your antenna position.</li></ul>
Picture is snowy (image noise)	<ul style="list-style-type: none"><li>• Your antenna may be damaged, disconnected or turned. Check the antenna connection. If the antenna is damaged, replace it.</li></ul>
Screen is 80% black	<ul style="list-style-type: none"><li>• The Closed Caption Text mode is on. Turn it off in the Closed Caption Menu, page 39.</li></ul>
Stereo or bilingual programs can't be heard	<ul style="list-style-type: none"><li>• Make sure the MTS settings are correct. See "MTS" on page 36.</li></ul>
There is no sound from the TV's speakers	<ul style="list-style-type: none"><li>• The TV Speaker option may be turned off. See page 38.</li></ul>
Static electricity	<ul style="list-style-type: none"><li>• It is normal to feel static electricity if you brush or touch the screen.</li></ul>
You hear occasional crackling sounds	<ul style="list-style-type: none"><li>• It is normal for the TV to make crackling sounds when first turned on or off. Unless the sound or picture become abnormal, this is fine.</li></ul>

For Canadian model televisions, see the separate sheet for Canadian Warranty information.

JVC COMPANY OF AMERICA warrants this product and all parts thereof, except as set forth below **ONLY TO THE ORIGINAL PURCHASER AT RETAIL** to be **FREE FROM DEFECTIVE MATERIALS AND WORKMANSHIP** from the date of original retail purchase for the period shown below (the "Warranty Period") (PICTURE TUBE is covered for Two (2) years.)

<b>Parts</b>	<b>Labor</b>
<b>1 YEAR</b>	<b>1 YEAR</b>

**THIS LIMITED WARRANTY IS VALID ONLY IN THE FIFTY (50) UNITED STATES, THE DISTRICT OF COLUMBIA AND COMMONWEALTH OF PUERTO RICO.**

**WHAT WE WILL DO:**

If this product is found to be defective within the warranty period, JVC will repair or replace defective parts at no charge to the original owner. Such repair and replacement services shall be rendered by JVC during regular business hours at JVC authorized service centers. Parts used for replacement are warranted only for the remainder of this Warranty Period. All products and parts thereof may be brought to a JVC authorized service center on a carry-in basis. Televisions with a screen size of 25 inches and larger may be covered on an in-home basis where such service is available.

**WHAT YOU MUST DO FOR WARRANTY SERVICE:**

To determine if in-home service is available in your area, either contact the selling dealer (retailer) or call 1-800-537-5722 to locate the nearest JVC authorized service center. Service locations can also be obtained from our website <http://www.jvcservice.com>. In-home service, if available, will require clear access to the Television by the service representatives. If in-home service is not available, carry in service will be provided.

If service is not locally available, box the product carefully, preferably in its original carton, and ship, insured, with a copy of your bill of sale plus a letter of explanation of the problem to the nearest JVC Factory Service Center, the name and location which will be given to you by the toll free number.

If you have any questions concerning your JVC Product, please contact our Customer Relations Department.

**WHAT IS NOT COVERED:**

This limited warranty provided by JVC does not cover:

- 1) Products which have been subject to abuse, accident, alteration, modification, tampering, negligence, misuse, faulty installation, lack of reasonable care, or if repaired or serviced by anyone other than a service facility authorized by JVC to render such service, or if affixed to any attachment not provided with the products, or if the model or serial number has been altered, tampered with, defaced or removed;
- 2) Initial installation, installation and removal from "built-in" entertainment centers and other mounting systems;
- 3) Operational adjustments covered in the Owner's Manual, normal maintenance, video and audio head cleaning;
- 4) Damage that occurs in shipment, due to an act of God, and cosmetic damage;
- 5) Signal reception problems and failures due to line power surge;
- 6) Video Pick-up Tubes/CCD Image Sensor, Cartridge, Stylus (Needle) are covered for 90 days from the date of purchase;





---

# Authorized Service Centers

QUALITY **JVC** SERVICE

*HOW TO LOCATE YOUR JVC SERVICE CENTER*

**TOLL FREE: 1 (800) 537-5722**

<http://www.jvc.com>

Dear Customer,

In order to receive the most satisfaction from your purchase, please read the instruction booklet before operating the unit. In the event that repairs are necessary, or for the address nearest your location within the Continental United States, please call 1 (800) 537-5722 for your nearest authorized servicer or visit our website at **www.JVC.com**.

Remember to retain your Bill of Sale for Warranty Service.

---

**Do not service the television yourself**

---

## **Caution**

To prevent electrical shock, do not open the cabinet. There are no user serviceable parts inside. Please refer to qualified service personnel for repairs.

## **Accessories**

To purchase accessories for your JVC product, you may contact your local JVC Dealer. From the 48 Continental United States call toll free: 1 (800) 882-2345 or on the web at **www.JVC.com**

---

## **For service in Canada**

To locate your local JVC service center or dealer in Canada please call:

In Eastern Canada:  
1 (416) 293-1311

In Western Canada:  
1 (604) 270-1311

En Français (Montréal):  
1 (514) 871-1311

Or visit us on the web at **www.JVC.ca**

# Search Codes

---

## Cable/Satellite Search Codes Function:

- 1) Slide the first 2-Way Mode Selector switch to CATV.
- 2) Press the TV POWER and RETURN+ buttons. Hold for at least three seconds and release.
- 3) Press TV POWER, see if the CATV or Satellite box responds.
- 4) If there was a response, press RETURN+. The operating codes are now set. If there was no response, repeat Step 3. If you repeat Step 3 a total of 52 times without a response, use the remote control which came with the equipment.
- 5) Press RETURN+ to exit.

## VCR Search Codes Function:

- 1) Slide the first 2-way selector switch to "TV" and the other 2-way selector switch to "VCR".
- 2) Press the VCR POWER and RETURN+ buttons. Hold for at least three seconds and release.
- 3) Press VCR POWER, see if the VCR responds.
- 4) If there was a response, press RETURN+. The operating codes are now set. If there was no response, repeat Step 3. If you repeat Step 3 a total of 80 times without a response, use the manufacturers remote control which came with the VCR.
- 5) Press RETURN+ to exit.

## DVD Player Search Codes Function:

- 1) Slide the first 2-way selector switch to "TV" and the other 2-way selector switch to "DVD".
- 2) Press the DVD POWER and RETURN+ buttons. Hold for at least three seconds and release.
- 3) Press DVD POWER, see if the DVDplayer responds.
- 4) If there was a response, press RETURN+. The operating codes are now set. If there was no response, repeat Step 3. If you repeat Step 3 a total of 30 times without a response, use the manufacturers remote control which came with the DVDplayer.
- 5) Press RETURN+ to exit.

# Specifications

Model	AV-27F702 AV-27F802	AV-32F702 AV-32F802	AV-36F702 AV-36F802
Reception Format	NTSC, BTSC System (Multi-Channel Sound)		
Reception Range	VHF 2 to 13, UHF 14 to 69 Sub Mid, Mid, Super, Hyper and Ultra Bands (181 channel frequency synthesizer system)		
Power Consumption	140W	155W	160W
Power Source	AC 120V, 60Hz		
Screen Size	27 inch / 68 cm measured diagonally	32 inch / 80 cm measured diagonally	36 inch / 90 cm measured diagonally
Speakers	2" x 4 3/4" / 5 x 12 cm oval x 2		
Audio Output	5W + 5W		
Antenna Terminal	75 ohms (VHF/UHF) (F-type connector)		
External Input Jacks	Video: 1 Vp-p, 75 ohms Audio: 500mVrms (-4dBs) high impedance		
S-Video Input Jacks	Y: 1Vp-p positive, 75 ohms (negative sync provided) C: 0.286 Vp-p (burst signal), 75 ohms		
Component Input Jacks	Y: 1Vp-p positive, 75 ohms (negative sync provided) Pb/P: 0.7 Vp-p, 75 ohms		
Audio Output Jacks (VAR/FDX)	Var: More than 0 to 1550 mVrms (+6 dBs) Fixed: 500mVrms (-4dBs) low impedance (400 Hz when modulated 100%)		
AV Compu Link EX Jack	3.5 mm mini jack x 1		
Dimensions WxHxD (inch/cm)	29 7/8" x 23 3/8" x 19 3/4" 75.8 x 59.3 x 50.0	34 5/8" x 27 5/8" x 22 1/4" 87.7 x 69.9 x 56.5	38 1/8" x 30 3/8" x 24 1/8" 96.7 x 77.0 x 61.0
Weight (lbs/kg)	101.2 (lbs) / 46 (kg)	140.8 (lbs) / 64 (kg)	187.0 (lbs) / 85.0 (kg)
Accessories	Remote control unit / AA batteries x 2		

Specifications subject to change without notice.

**JVC COMPANY OF AMERICA**  
Division of JVC Americas Corp.  
1700 Valley Road  
Wayne, New Jersey, 07470



**JVC CANADA, INC.**  
21 Finchdene Square  
Scarborough, Ontario  
Canada, M1X 1A7