

JVC



DVD DIGITAL THEATER SYSTEM

TH-A25

Consists of XV-THA25 and SP-THA25

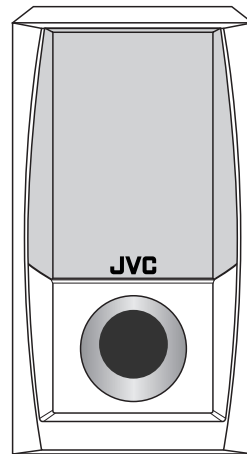
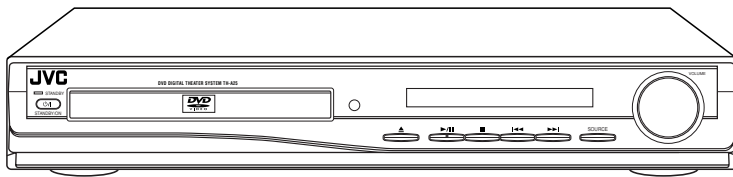
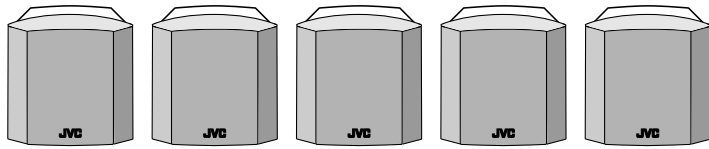

INSTRUCTIONS

For Customer Use:

Enter below the Model No. and Serial No. which are located either on the rear, bottom or side of the cabinet. Retain this information for future reference.

Model No. _____

Serial No. _____

Warnings, Cautions and Others

<div style="display: inline-block; text-align: center; border: 1px solid black; padding: 2px; margin: 0 10px;"> CAUTION <small>RISK OF ELECTRIC SHOCK DO NOT OPEN</small> </div>
<p>CAUTION: TO REDUCE THE RISK OF ELECTRIC SHOCK. DO NOT REMOVE COVER (OR BACK) NO USER SERVICEABLE PARTS INSIDE. REFER SERVICING TO QUALIFIED SERVICE PERSONNEL.</p>

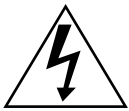

The lightning flash with arrowhead symbol, within an equilateral triangle is intended to alert the user to the presence of uninsulated "dangerous voltage" within the product's enclosure that may be of sufficient magnitude to constitute a risk of electric shock to persons.



The exclamation point within an equilateral triangle is intended to alert the user to the presence of important operating and maintenance (servicing) instructions in the literature accompanying the appliance.

WARNING: TO REDUCE THE RISK OF FIRE OR ELECTRIC SHOCK, DO NOT EXPOSE THIS APPLIANCE TO RAIN OR MOISTURE.

CAUTION

To reduce the risk of electrical shocks, fire, etc.:

1. Do not remove screws, covers or cabinet.
2. Do not expose this appliance to rain or moisture.

Caution — STANDBY/ON \odot /I switch!
 Disconnect the mains plug to shut the power off completely. The STANDBY/ON \odot /I switch in any position does not disconnect.

Note to CATV system installer:
 This reminder is provided to call the CATV system installer's attention to Section 820-40 of the NEC which provides guidelines for proper grounding and, in particular, specifies that the cable ground shall be connected to the grounding system of the building, as close to the point of cable entry as practical.

For U.S.A
 This equipment has been tested and found to comply with the limits for a Class B digital device, pursuant to part 15 of the FCC Rules. These limits are designed to provide reasonable protection against harmful interference in a residential installation. This equipment generates, uses and can radiate radio frequency energy and, if not installed and used in accordance with the instructions, may cause harmful interference to radio communications. However, there is no guarantee that interference will not occur in a particular installation. If this equipment does cause harmful interference to radio or television reception, which can be determined by turning the equipment off and on, the user is encouraged to try to correct the interference by one or more of the following measures:
 Reorient or relocate the receiving antenna.
 Increase the separation between the equipment and receiver.
 Connect the equipment into an outlet on a circuit different from that to which the receiver is connected.
 Consult the dealer or an experienced radio/TV technician for help.

IMPORTANT FOR LASER PRODUCTS

1. CLASS 1 LASER PRODUCT
2. **CAUTION:** Do not open the top cover. There are no user serviceable parts inside the Unit; leave all servicing to qualified service personnel.
3. **CAUTION:** Visible and invisible laser radiation when open and interlock failed or defeated. Avoid direct exposure to beam.
4. REPRODUCTION OF LABEL: CAUTION LABEL, PLACED INSIDE THE UNIT.

CAUTION : INVISIBLE LASER RADIATION WHEN OPEN AND INTERLOCKS DEFEATED AVOID EXPOSURE TO BEAM
ADVARSAL : USYNLIG LASERSTRÅLING VED ÅBNING NÅR SIKKERHEDSAFBRYDERE ER UDE AF FUNKTION UNDGA UDSÆTTELSE FOR STRÅLING
VARO : AVATTAESSA JA SUOJALUKITUS OHITETTAESSA OLET ALLTTINA NÄKYMÄTTÖ MÄLLELASERISÄTELYLLE ALA KÄTSO SÄTEESEEN!
VARNING : OSYNLIG LASERSTRÅLNING NÄR DENNA DEL ÄR ÖPPNAD OCH SPÄRREN ÄR URKOPPLAD BETRÄKTA EJ STRÅLEN!

Caution: Proper Ventilation

To avoid risk of electric shock and fire and to protect from damage. Locate the apparatus as follows:

Front: No obstructions open spacing.
 Sides: No obstructions in 10 cm from the sides.
 Top: No obstructions in 10 cm from the top.
 Back: No obstructions in 15 cm from the back
 Bottom: No obstructions, place on the level surface.
 In addition, maintain the best possible air circulation as illustrated.

XV-THA25
Front

Stand height 15 cm or more

Floor

Table of Contents

Parts Identification	2	Selecting the Audio Languages	24
Center Unit	2	Selecting the Subtitles	24
Remote Control	3	Selecting the Playback Channel	25
Getting Started	4	Selecting the Multi-Angle Views	25
Before Installation	4	Checking the Remaining Time	25
Checking the Supplied Accessories	4	Disc Menu-Driven Playback	26
Putting Batteries in the Remote Control	4	Moving to a Particular Portion Directly	27
Connecting the FM and AM Antennas	5	Searching for a Particular Point	27
Speaker Layout Diagram	6	Repeating Playback	28
Connecting the Speakers	7	■ Repeat Play	28
Connecting Audio/Video Component	8	■ A-B Repeat	28
TV Settings	10	Special Picture Playback	29
Changing the Scanning Mode	10	■ Still Picture/Frame-by-Frame Playback	29
Operating TV	11	■ Slow Motion Playback	29
Basic Disc Operations	12	■ Zoom	29
1 Turn On the Power	12	MP3/JPEG Introduction	30
2 Select the Source	12	MP3/JPEG Playback	31
3 Load a Disc	12	Starting Playback	31
4 Start Playback	13	Showing the On-Screen Bar	31
5 Adjust the Volume	13	Operations Using the On-Screen Display	32
6 Activate Surround	13	Selecting a Particular File/Folder Directly	33
Moving to Another Chapter/Track/File	14	Repeating Playback	33
Stopping Playback	14	Browsing Pictures in the Current Folder	33
Basic Tuner Operations	15	Rotating and Flipping a Picture	33
1 Turn On the Power	15	Tuner Operations	34
2 Select the Band	15	Tuning in Stations	34
3 Adjust the Volume	15	Using Preset Tuning	35
4 Tune into a Station	15	Selecting the FM Reception Mode	35
Other Basic Operations	16	Setting Up the DVD Preferences	36
Enjoying Sounds from the External Component	16	Setting the System Preferences	36
Turning Off the Power with the Timer	16	■ The basic procedure to set up the system preferences	37
Adjusting the Display Brightness	16	■ To adjust the DRC (Dynamic Range Compression)	37
Creating Realistic Sound Fields	17	Setting the Preferences	38
Using the Test Tone	17	■ The basic procedure to set up preferences	38
Adjusting the Sound	17	■ To set the parental (rating) level	39
■ Basic sound adjustment procedure	18	■ To change the password	39
Surround Mode Introduction	19	■ To release the parental lock temporarily	40
■ Dolby Digital and DTS Digital Surround	19	■ Language Code List	40
■ Dolby Pro Logic II modes	19	Maintenance	41
Activating the Surround Mode	20	Troubleshooting	42
Disc Introduction—DVD/VCD/SVCD/CD	21	Specifications	43
Disc Playback	22		
Using the On-Screen Bar	22		
■ Showing the On-Screen Bar	22		
■ Basic operation through the On-Screen Bar	23		

Parts Identification

Center Unit

Front Panel

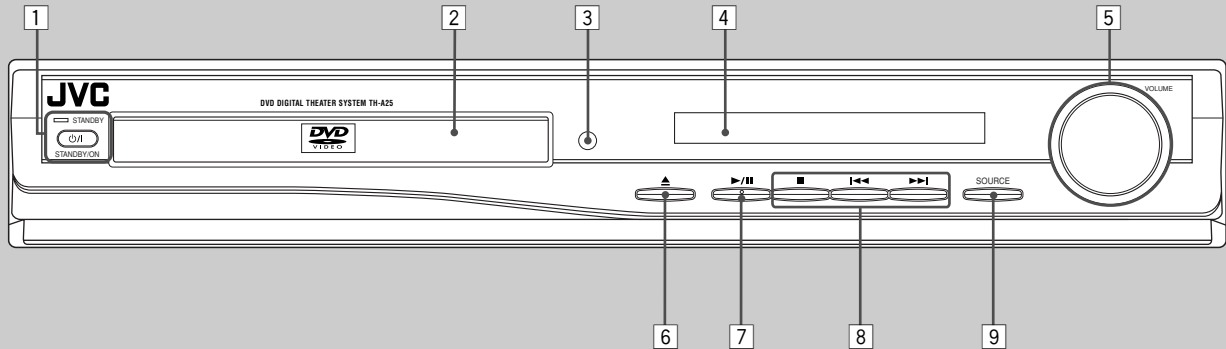

See pages in the parentheses for details.

Front Panel

- 1 STANDBY/ON \odot/I button and STANDBY lamp (12–15)
- 2 Disc tray (12)
- 3 Remote sensor
- 4 Display
- 5 VOLUME control (13, 15)
- 6 \blacktriangle (open/close) button (12, 14)
 - Pressing this button also turns on the power and changes the source to the DVD/CD.
- 7 $\blacktriangleright/\text{II}$ (play/pause) button (13, 14, 31)
 - Pressing this button also turns on the power and changes the source to the DVD/CD.
- 8 Multi operation buttons
 - \blacktriangleleft , \blacktriangleright , and \blacksquare
- 9 SOURCE button (12, 15, 16)

Display

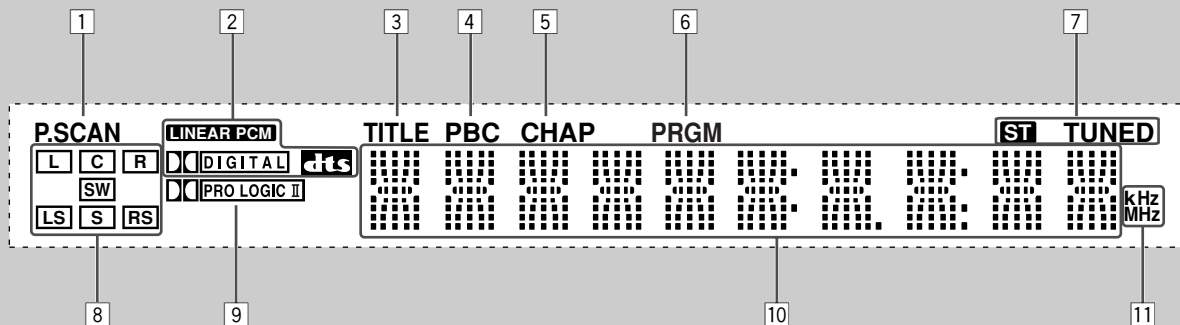

See pages in the parentheses for details.

Display

- 1 P.SCAN indicator (10)
- 2 Digital signal indicators (13, 19, 20)
 - LINEAR PCM, DOLBY DIGITAL, and DTS.
- 3 TITLE indicator (13)
 - Indicates the current title number with main display.
- 4 PBC (Play Back Control) indicator
 - Goes on when the PBC function is activated.
- 5 CHAP (chapter) indicator (13)
 - Indicates the current chapter number with main display.
- 6 PRGM (program) indicator (35)
- 7 Tuner mode indicators (15, 34, 35)
 - ST (stereo) and TUNED
- 8 Audio channel indicators
 - Indicates audio channels currently being reproduced.
- 9 Dolby PRO LOGIC II indicator (13, 19, 20)
- 10 Main display
- 11 Frequency unit indicators
 - kHz (for AM band station) and MHz (for FM band station)

Remote Control

Remote Control

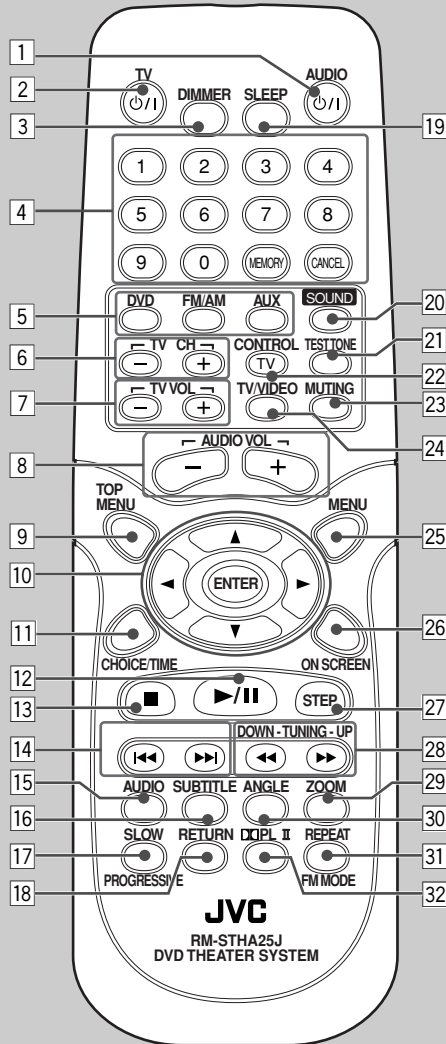

See pages in the parentheses for details.

- 1 AUDIO \odot /I button (12, 14, 15)
- 2 TV \odot /I button (11,12)
- 3 DIMMER button (16)
- 4 • Number buttons
• MEMORY button (35)
• CANCEL button
- 5 Source selecting buttons
• DVD, FM/AM, AUX (10, 12, 15, 16)
• *Pressing one of these buttons also turns on the power.*
- 6 TV CH + and – buttons (11)
- 7 TV VOL + and – buttons (11)
- 8 AUDIO VOL + and – buttons (13, 15)
- 9 TOP MENU button (26)
- 10 • \blacktriangleright , \blacktriangleleft , \blacktriangleup , and \blacktriangledown buttons
• ENTER button
- 11 CHOICE/TIME button (25, 31, 37–39)
- 12 \blacktriangleright /II button
- 13 ■ button
- 14 $\blacktriangleleft\blacktriangleleft$ and $\blacktriangleright\blacktriangleright$ buttons
- 15 AUDIO button (24, 25)
- 16 SUBTITLE button (24)
- 17 • SLOW button (29)
• PROGRESSIVE button (10)
- 18 RETURN button (26)
- 19 SLEEP button (16)
- 20 SOUND button (18)
- 21 TEST TONE button (17)
- 22 CONTROL TV button (11)

IMPORTANT:

When you press CONTROL TV, some buttons on the remote control cannot work for operating the center unit. To operate the center unit, press DVD, FM/AM, or AUX depending on your target operation.

- 23 MUTING button (13)
- 24 TV/VIDEO button (11, 12)
- 25 MENU button (26, 33)
- 26 ON SCREEN button (22–28, 31)
- 27 STEP button (29)
- 28 • $\blacktriangleleft\blacktriangleleft$ and $\blacktriangleright\blacktriangleright$ buttons
• TUNING UP and DOWN buttons (15, 34)
- 29 ZOOM button (29)
- 30 ANGLE button (25)
- 31 • REPEAT button (28, 33)
• FM MODE button (35)
- 32 \square PL II button (13, 20)

Getting Started

Before Installation

General Precautions

- DO NOT insert any metal object into the center unit.
- DO NOT disassemble the center unit or remove screws, covers, or cabinet.
- DO NOT expose the center unit to rain or moisture.

Locations

- Install the center unit in a location that is level and protected from moisture.
- The temperature around the center unit must be between 5°C and 35°C.
- Make sure there is good ventilation around the center unit. Poor ventilation could cause overheating and damage the center unit.

Handling the center unit

- DO NOT touch the power cord with wet hands.
- DO NOT pull on the power cord to unplug the cord. When unplugging the cord, always grasp the plug so as not to damage the cord.
- Keep the power cord away from the connecting cords and the antenna. The power cord may cause noise or screen interference. It is recommended to use a coaxial cable for antenna connection, since it is well-shielded against interference.
- When a power failure occurs, or when you unplug the power cord, the preset settings such as preset FM/AM channels and sound adjustments may be erased in a few days.

Checking the Supplied Accessories

Check to be sure you have all of the following supplied accessories. The number in the parentheses indicates the quantity of the pieces supplied.

- Remote Control (1)
- Batteries (2)
- AM Loop Antenna (1)
- FM Antenna (1)
- Video Cord (1)
- Speaker Cords
 - 6 m (4): For subwoofer
For the satellite speakers on the following positions:
left front, right front, and center
 - 10 m (2): For the satellite speakers on left and right rear positions

If anything is missing, contact your dealer immediately.

Putting Batteries in the Remote Control

Before using the remote control, put two supplied batteries first.

- When using the remote control, aim the remote control directly at the remote sensor on the center unit.

1. On the back of the remote control, remove the battery cover.

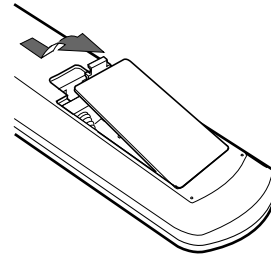

2. Insert batteries. Make sure to match the polarity: (+) to (+) and (-) to (-).

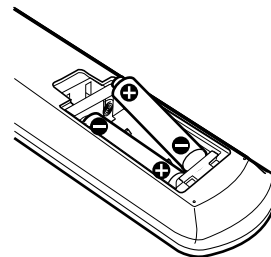

3. Replace the cover.

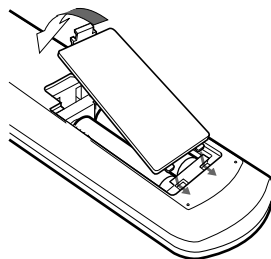

If the range or effectiveness of the remote control decreases, replace the batteries. Use two R6P(SUM-3)/AA(15F) type dry-cell batteries.

CAUTION:

Follow these precautions to avoid leaking or cracking cells:

- Place batteries in the remote control so they match the polarity: (+) to (+) and (-) to (-).
- Use the correct type of batteries. Batteries that look similar may differ in voltage.
- Always replace both batteries at the same time.
- Do not expose batteries to heat or flame.

Connecting the FM and AM Antennas

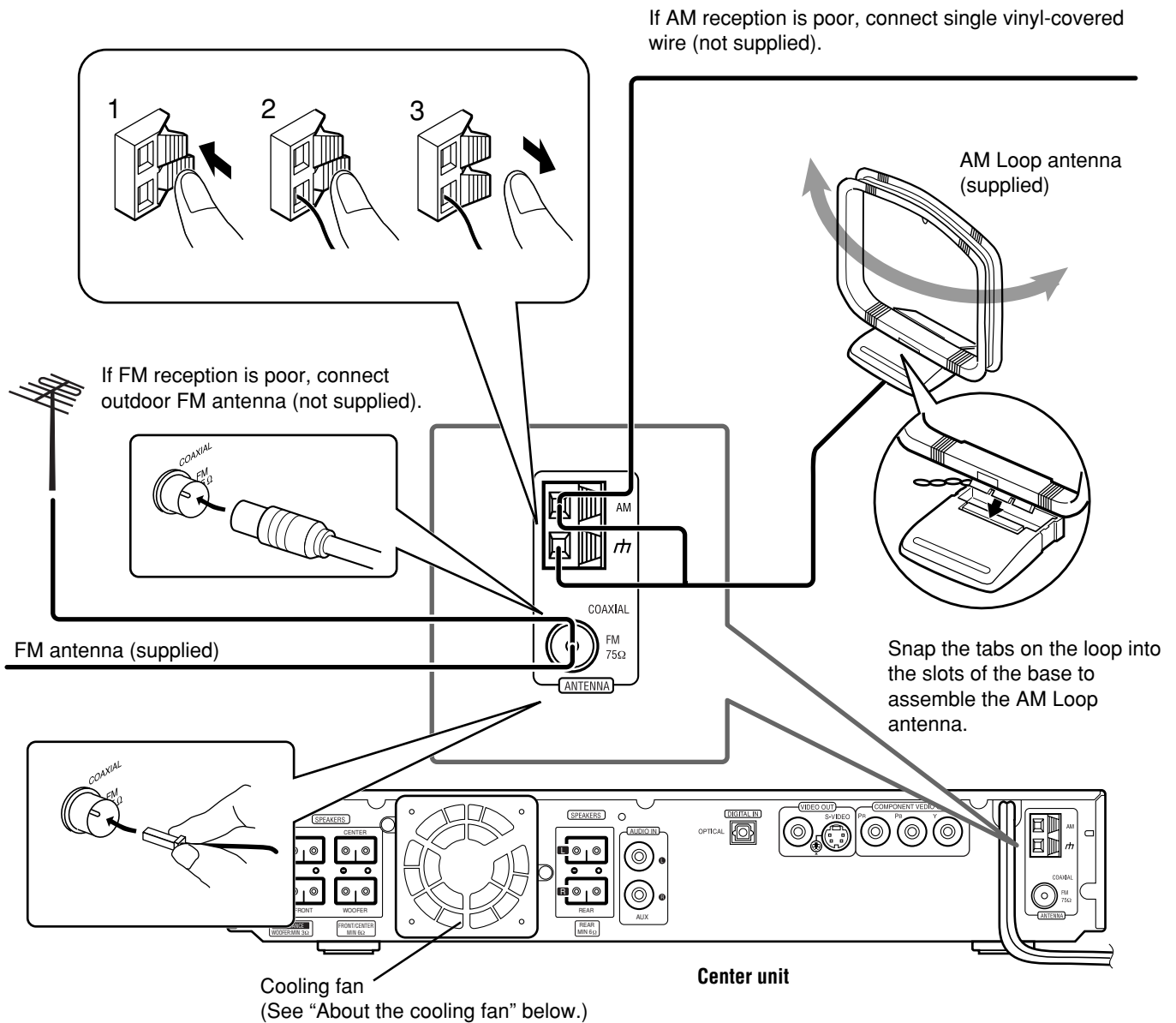

FM antenna connection

Connect the supplied FM antenna to the COAXIAL FM 75 Ω terminal as temporary measure.

Extend the supplied FM antenna horizontally.

- If reception is poor, connect an outdoor antenna. Before attaching a 75 Ω coaxial cable (with a standard type connector), disconnect the supplied FM antenna.

AM antenna connection

Connect the supplied AM Loop antenna to the AM and rh terminals. Turn the loop until you have the best reception.

- If reception is poor, connect an outdoor single vinyl-covered wire to the AM terminal. (Keep the AM Loop antenna connected.)

Notes:

If the AM Loop antenna wire is covered with vinyl, remove the vinyl by twisting it as shown in the diagram.



About the cooling fan

A cooling fan is mounted on the rear panel of the center unit to prevent abnormal temperature inside the center unit, thus assuring normal operation of the unit. The cooling fan automatically starts rotating to intake external cool air when the internal temperature goes up.

For safety, observe the following carefully.

- Make sure there is good ventilation around the center unit. Poor ventilation could overheat and damage the center unit.
- DO NOT block the cooling fan and the ventilation openings or holes. (If they are blocked by a newspaper or cloth, etc., the heat may not be able to get out.)
- DO NOT touch the speaker cords to the cooling fan.

Getting Started

Speaker Layout Diagram

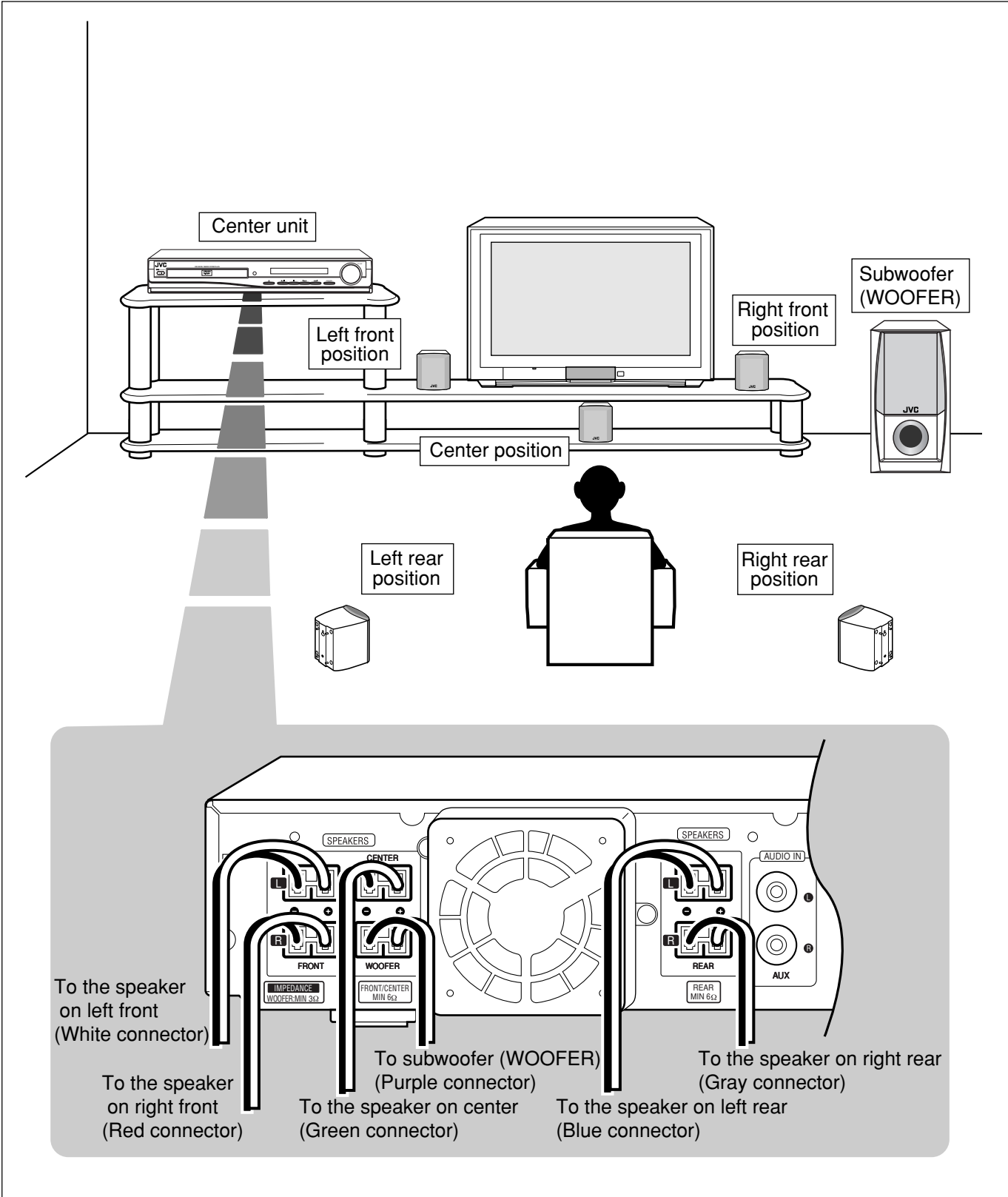

Connecting the Speakers

Connect the satellite speakers and subwoofer to the terminals on the rear panel using speaker cords supplied. The ends of the speaker cords are colored to indicate the terminals to be connected.

CAUTION:

Use speakers with the **SPEAKER IMPEDANCE** indicated by the speaker terminals.

Connecting speaker cords to the speakers

- Connect the cord with a gray tube to the red (+) terminal, and the cord with a black tube to the black (-) terminal respectively.
- You can use the satellite speakers interchangeably for any position except for subwoofer. Make sure not to connect the subwoofer terminal and the satellite speaker.

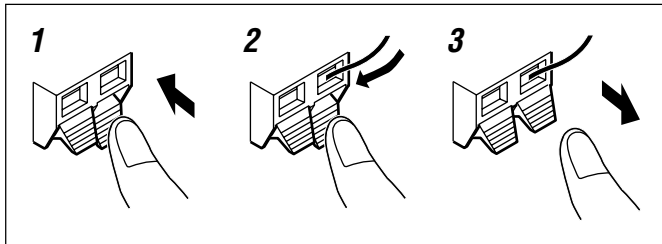

1 Press and hold the terminal clamp.

2 Insert the speaker cord.

3 Release the finger from the clamp.

Notes:

- If the speaker cord is covered with vinyl, remove the vinyl by twisting it as shown in the diagram.
- Make sure the core wire of speaker cords do not expose to out of the terminals. This could cause short-circuit.

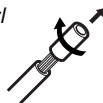

Connecting speaker cords to the center unit

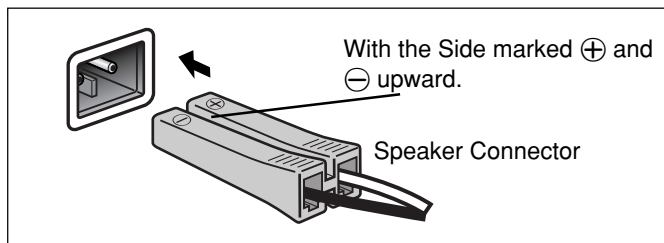

Insert the speaker connectors to the speaker terminals on the rear panel.

- Make sure to match the color of the connector and the terminal.

When setting the speakers

To obtain the best possible sound from this system, you need to place all the speakers except the subwoofer at the same distance from the listening position with each front faced toward the listener. Since bass sound is non-directional, you can place a subwoofer wherever you like. Normally place it in front of you.

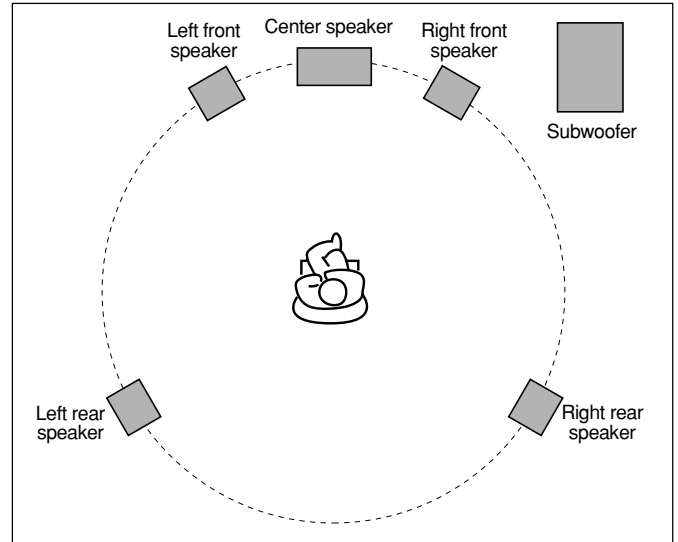

If your speakers cannot be placed at the same distance from the listening position

You can adjust the delay time of the center speaker and rear speakers. For in-depth information about adjusting the delay time, see "Adjusting the Sound" on page 17.

Notes:

You can change the phase of subwoofer sounds by connecting the speaker cords to the terminals inversely—the cord with a gray tube to the black terminal, and the cord with a black tube to the red terminal. You may get more effective bass sounds by changing the phase.

CAUTIONS:

- When attaching the satellite speakers on the wall, have them attached to the wall by a qualified person. DO NOT attach the satellite speakers on the wall by yourself to avoid an unexpected damage of their falling from the wall, caused by incorrect attachment or weakness in the wall.
- Care is required in selecting a location for attaching speakers to the wall. Injury to personnel, or damage to equipment, may result if the speakers are attached in a location which interferes with daily activities.

Getting Started

Connecting Audio/Video Component

Turn the power off to all components before connections.

TV connection

The S-video cord and the component video cord are not supplied with this system.
Use the cords supplied with another components or purchase them at an electric appliance store.

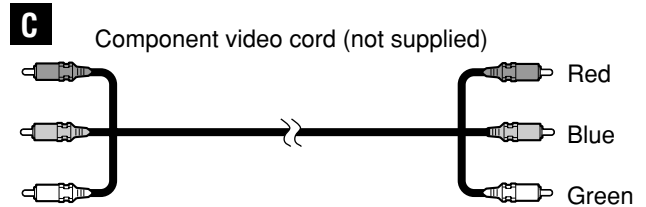
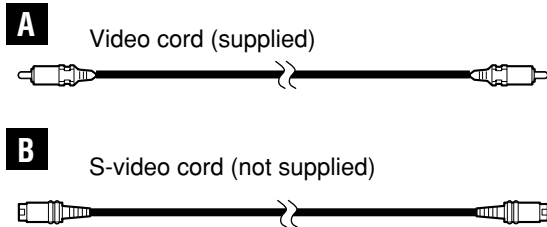

You can select one of three connection types—**A**, **B**, and **C**.

- If your TV has S-video (Y/C-separation) and/or component video (Y, Pb, Pr) jacks, connect them using an S-video cord (not supplied) **B** and/or component video cord (not supplied) **C**.
By using these jacks, you can get a better picture quality—in the order : Component video > S-video > Composite video.

- If your TV equipped with component video jacks supports the progressive video input, you can enjoy a high quality picture by making the progressive scanning mode active (see page 10.)

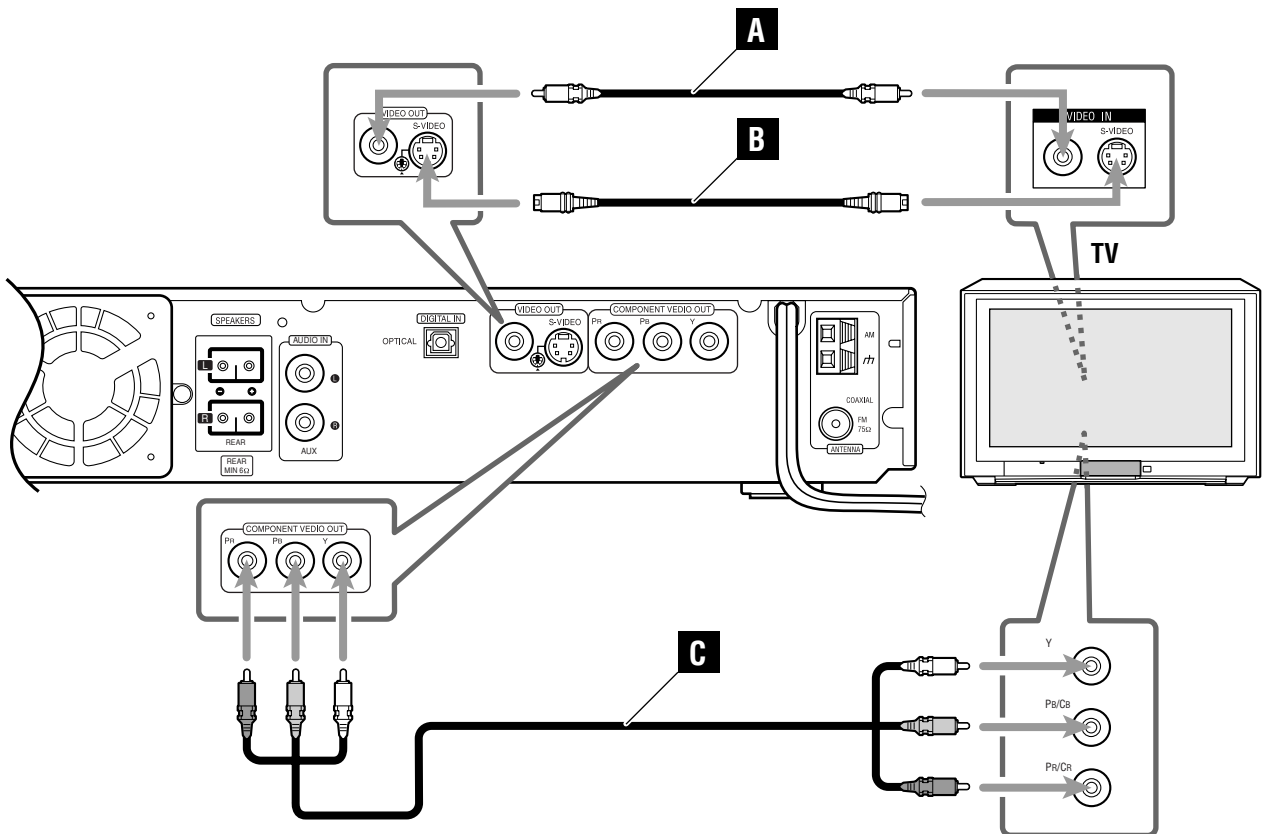

Audio component connection

Connect other components to the center unit with the audio cord.
Use the cord supplied with the other component or purchase one at an electric appliance store.

A Optical digital cord (not supplied)

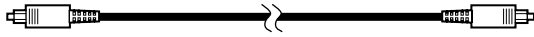

B Audio cord (not supplied)

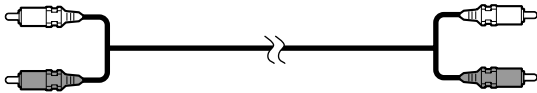

Illustrations of the input/output terminals below are typical examples.
When you connect other components, refer also to their manuals since the terminal name actually printed on the rear vary among the components.

If you connect a sound-enhancing device such as a graphic equalizer between the source component and the center unit, the sound output through this system may be distorted.

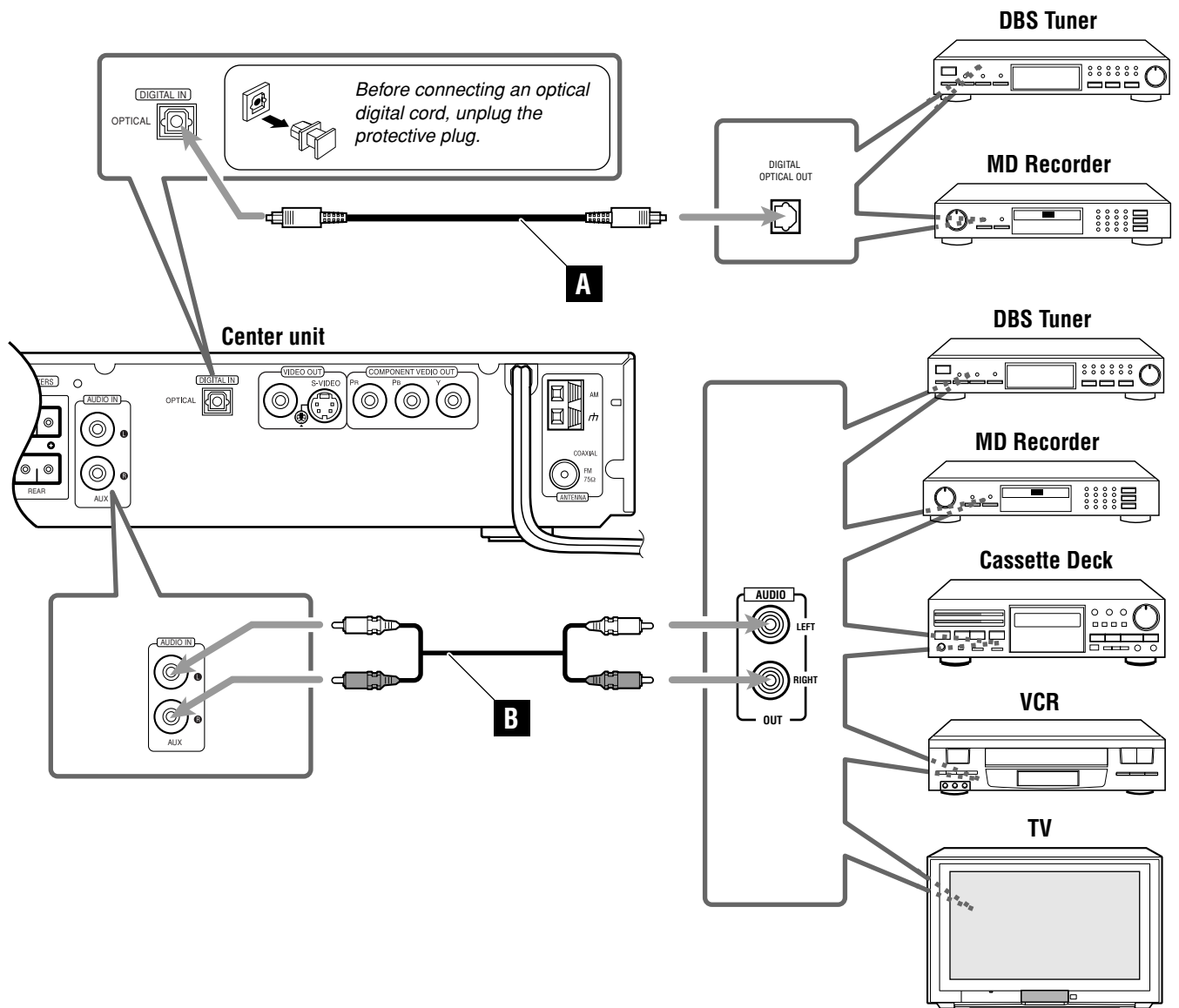

Now, you can plug the power cord of the center unit into the AC outlet.

Notes:

- Keep the power cord away from the connecting cords and the antenna. The power cord may cause noise or screen interference.
- Connecting to a TV through a VCR, or to a TV with a built-in VCR, may cause distortion of picture.

TV Settings

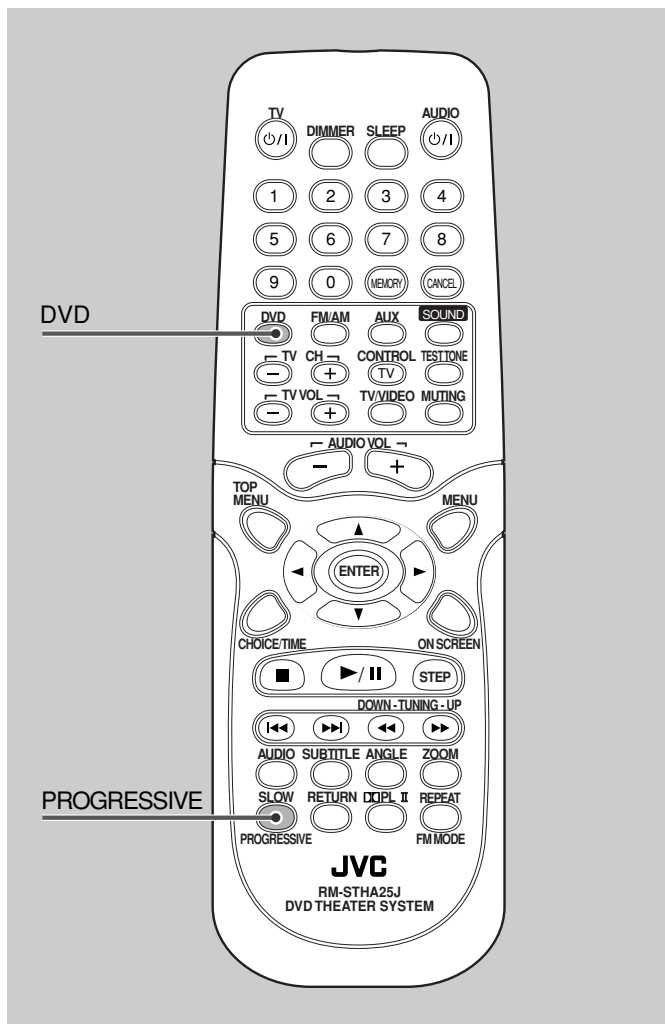

Changing the Scanning Mode

This system supports the progressive scanning system (480p*) as well as the conventional interlaced scanning system (480i*). If your TV equipped with component video jacks supports the progressive video input, you can enjoy a high quality picture by activating the progressive scanning mode.

- Refer also to the instruction manuals supplied with your TV.
- If your TV equipped with component video jacks does not support the progressive video input, do not change the scanning mode to the progressive scanning mode.

* 480p and 480i indicate the number of scanning lines and scanning format of a video signal.

- 480p indicates 480 scanning lines with progressive format.
- 480i indicates 480 scanning lines with interlaced format.

You can select the scanning mode if your TV equipped with component video jacks supports the progressive video input.

From the remote control ONLY:

1 Press DVD.



2 Press and hold PROGRESSIVE for a while.



- Each time you press and hold the button, the scanning mode alternates between “INTERLACE TV” and “PROGRESSIVE TV.”

INTERLACE TV:

Select this if your TV does not support the progressive video input (conventional TV).

PROGRESSIVE TV:

Select this if your TV equipped with component video jacks supports the progressive video input.

When you select the “PROGRESSIVE TV,” P.SCAN indicator lights up on the display.

Notes:

- Some progressive TVs and High-Definition TVs are not fully compatible with this system, resulting in the unnatural picture when playing back a DVD in the progressive scanning mode. In such a case, change the scanning mode to “INTERLACE TV.” To check the compatibility of your TV, contact your local JVC customer service center.
- All JVC progressive TVs and High-Definition TVs are fully compatible with this system.

About scanning system

The conventional scanning method to display video signals on the TV screen is called “Interlaced scanning.” With this method, only half of the horizontal lines (called a “field”) are displayed at a time. So two fields complete a single picture (frame); i.e., the first field, containing all the odd-numbered lines, is followed by the second field, containing all the even-numbered lines.

On the other hand, the Progressive scanning system scans all horizontal lines at a time, so you can double the number of scanning lines displayed at a time, resulting in a flicker-free, high-density picture.

To enjoy the progressive scanned picture, a monitor (or TV or projector) connected to the system must support the progressive video inputs.

Depending on the material source format, DVD video can be classified into two types; film source and video source (note that some DVD video contain both film source and video source). Film sources are recorded as 24-frame-per-second data, while (NTSC) video sources are recorded as 30-frame-per-second (60-field-per-second interlaced).

When this system plays back a film source data, uninterlaced progressive output signals are created using the original data. When a video source is played back, the unit interleaves lines between the interlaced lines to create the pseudo uninterlaced picture and outputs as the progressive signals.

Operating TV

You can use the remote control to operate not only this unit but also JVC's TV.

- Refer also to the manuals supplied for the other products.
- To operate the TV, aim the remote control directly at the remote sensor on the TV.

❑ To operate a JVC's TV

You can perform the following operations on the TV.

TV ϕ/I:	Turn on or off the TV.
TV VOL +/-:	Adjust the volume.
TV/VIDEO:	Set the input mode (either TV or VIDEO).
TV CH +/-:	Change the channels.
1-9, 0, MEMORY:	Select the channels.

After pressing **CONTROL TV** on the remote control, you can select TV channel directly with the number buttons and MEMORY.



- For some TVs, MEMORY works to change the channel entry between one digit and two digits.

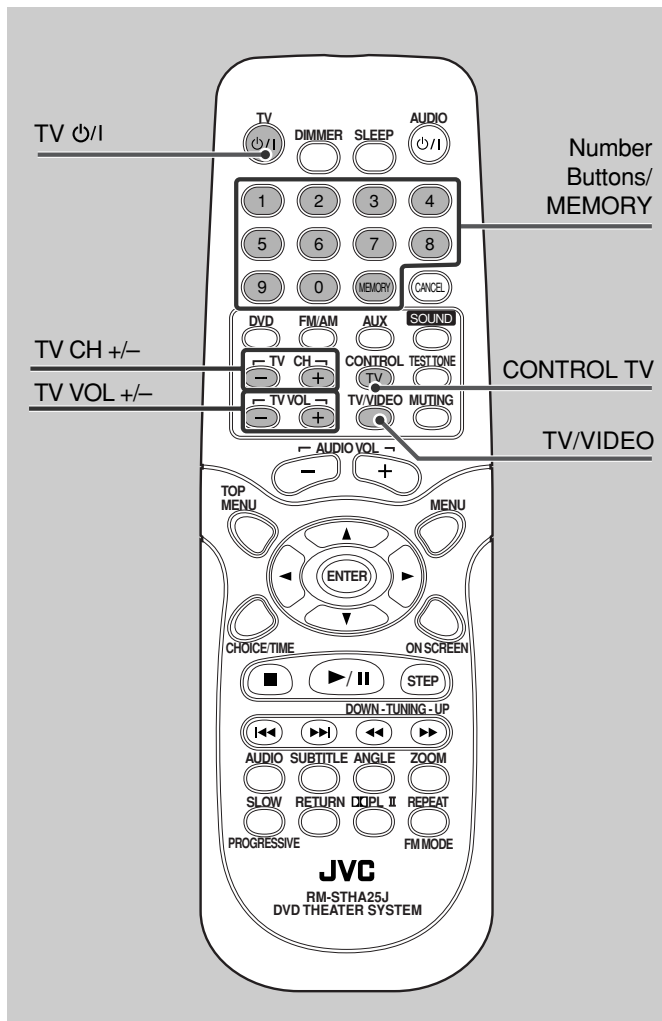

IMPORTANT:

When you press **CONTROL TV**, some buttons on the remote control cannot work for operating the system.

To operate the system, press **DVD, FM/AM, or AUX**.

Basic Disc Operations

This manual mainly explains operations using the buttons on the remote control. You can also use the buttons on the center unit if they have the similar names (or marks) as those on the remote control.

If operations using the center unit are different from those using the remote control, they are then explained.

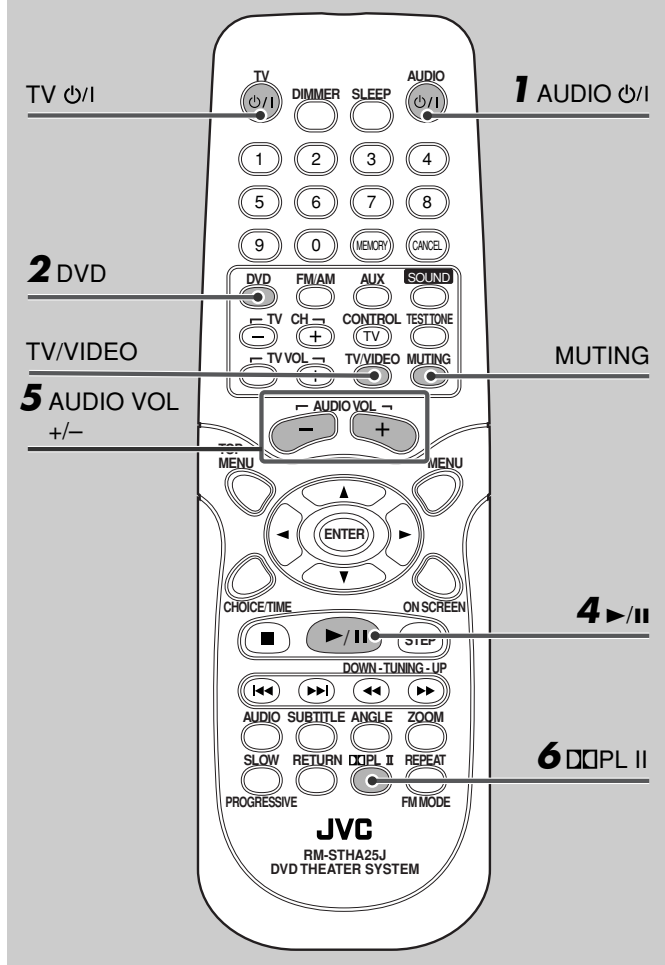

For in-depth information about disc operations, see pages 22 to 33.

1 Turn On the Power

Before turning on the system, turn on your TV and select the correct video input. (See the manual supplied with your TV.)

- For changing the OSD messages—the information on the TV screen—into the desired language, see “Setting the System Preferences” on page 36.

Press **AUDIO** (or **STANDBY/ON** on the front panel).

The STANDBY lamp goes off.
The source indication selected previously appears on the display.



2 Select the Source

From the remote control:

Press **DVD**.

The source changes to the DVD/CD player.



On the front panel:

Press **SOURCE** repeatedly until “DVD/CD” appears on the display.



3 Load a Disc

On the front panel ONLY:

Press to open the disc tray, then place a disc correctly with its label side up (for double-sided DVD, the side you want to playback up).

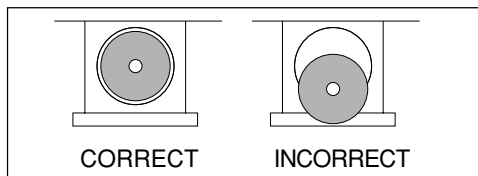

- When using an 8 cm disc, place it on the inner circle of the disc tray.
- Continued use of irregular shape discs (heart-shape, octagonal, etc.) can damage the center unit.
- DO NOT use the disc stabilizer.

4 Start Playback

Press ►/II.

The disc tray closes. "LOADING" appears on the display for a while.

- You can also start playback by closing the disc tray using ▲ on the front panel.
- Some discs show menus on the TV screen after you press ►/II. See "Disc Menu-Driven Playback" on page 26 and refer to the instructions supplied for the discs to use the menus.

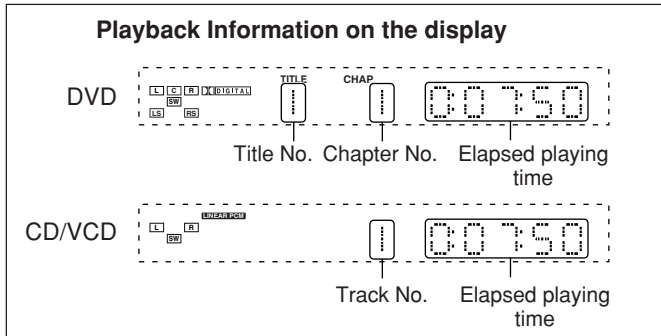
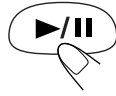

5 Adjust the Volume

From the remote control:

To increase the volume, press and hold AUDIO VOL +.

To decrease the volume, press and hold AUDIO VOL –.



On the front panel:

To increase the volume, turn VOLUME control clockwise.

To decrease the volume, turn VOLUME control counterclockwise.

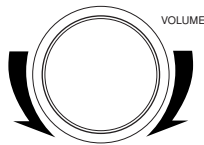

CAUTION:

Always set the volume to the minimum before starting any source. If the volume is set at its high level, the sudden blast of sound energy can permanently damage your hearing and/or ruin your speakers.

Notes:

- By pressing AUDIO VOL + or – repeatedly, you can adjust the volume level step by step.
- The volume level can be adjusted within 51 steps— "MIN (minimum)," "1" to "49," and "MAX (maximum)."
- If you have turned off the unit with the volume level set at more than level "25," the volume level will be automatically set at level "25" next time you turn on the unit.

To turn off the sounds temporarily

From the remote control ONLY:

Press MUTING.



To restore the sound, press MUTING again.

- Adjusting the volume also restores the sound.

6 Activate Surround

You can enjoy two kinds of surround—Digital Multichannel Surround (Dolby Digital and DTS Digital Surround) and Dolby Pro Logic II.

Digital Multichannel Surround—Dolby Digital and DTS Digital Surround

Dolby Digital or DTS Digital Surround takes effect only when you play back a disc encoded with these signals.

To activate Dolby Digital or DTS Digital Surround

When a Dolby Digital or DTS multi-channel disc is loaded, the system detects it and starts playing the disc automatically with Multichannel Surround activated.

or indicator lights up on the display according to the signal detected.

– For in-depth information about Multichannel Surround, see "Surround Mode Introduction" on page 19.

Dolby Pro Logic II modes—Pro Logic II Music, Pro Logic II Movie, Matrix, and Pro Logic

To activate Pro Logic II modes

You can use these modes when playing back any 2-channel sources either digital or analog.

Press PL II.

The current Pro Logic II mode appears on the display for a while.



- Each time you press the button, Pro Logic II mode changes as follows:

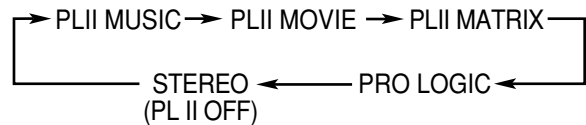

- When Dolby Pro Logic II mode is activated, the indicator lights up on the display.
- For in-depth information about Dolby Pro Logic II modes, see "Surround Mode Introduction" on page 19.

Basic Disc Operations

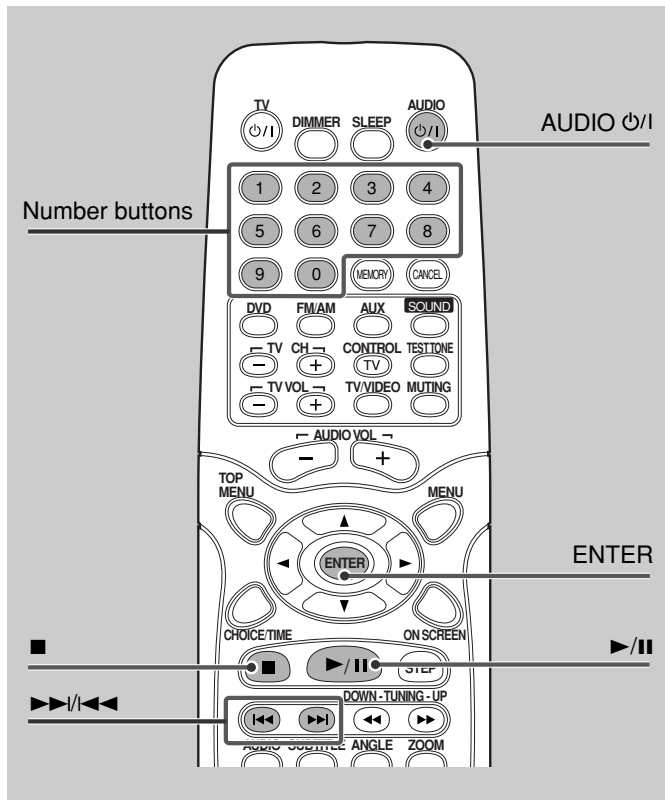

Moving to Another Chapter/Track/File

To go to another chapter (for DVD), track (for CD and VCD), or file (for MP3 and JPEG)

Press **▶▶** or **◀◀** repeatedly during playback.

- **▶▶**: Skips to the beginning of the next or succeeding chapter, track, or file.
- **◀◀**: Goes back to the beginning of the current or previous chapter, track, or file.
- You can skip some 5 minutes forward/back with pressing **▶▶/◀◀** while you are playing back a VCD track which is longer than some 15 minutes.

To go to another track (only possible on a CD and VCD without PBC) directly using the number buttons

Pressing the number buttons before or during play allows you to start playing the track number you want. If your TV is turned on, "SELECT XX" (XX is the selected track number) appears on the TV screen.

- To select number 1 to 9, press the corresponding number button, then press ENTER.
- To select number 15, press 1, 5, then press ENTER.
- To select number 23, press 2, 3, then press ENTER.

Stopping Playback

To stop playback

Press **■**.
Playback stops.



- This system can memorize the end point even when you press **■** once when playing back a DVD ("PRESS PLAY TO CONTINUE" appears on the TV screen). When you start playback again by pressing **▶/⏸**, playback begins from where it has been stopped—Resume play.
Press **■** again, then press **▶/⏸** to play back the DVD from the beginning.
- When you start playback an MP3 or a JPEG file again by pressing **▶/⏸**, playback begins from the beginning of the file which had been played before you stopped playback.
- For in-depth information about MP3/JPEG playback, see "MP3/JPEG Playback" on pages 31–33.

Notes:

- The TV screen gets dark to save the screen when you leave the system for a few minutes without any operations after stopping playback. Press some button to restore the screen brightness.
- When the source is "DVD/CD," the center unit turns off automatically to save electrical consumption in the following cases:
 - No playback starts for more than 20 minutes.
 - "NO DISC" is shown on the display for more than 20 minutes. Turn on the power again to use the system.

To stop playback for a moment

Press **▶/⏸**.

While pausing, the elapsed playing time flashes on the display.

- To resume play, press **▶/⏸** again.



To remove the disc

Press **▲**.

"OPEN" appears on the display and the disc tray comes out.



To close the disc tray, press **▲** again.

- If you do not press the button, the disc tray closes automatically in a few minutes.

To turn off the power (into standby)

Press **AUDIO ⏻/⏻** (or **STANDBY/ON ⏻/⏻** on the front panel).

The STANDBY lamp lights up.

- If you press **AUDIO ⏻/⏻** (or **STANDBY/ON ⏻/⏻** on the front panel) while the disc tray is kept open, the disc tray closes automatically, then the system is turned off.
- A small amount of power is consumed even in standby mode. To turn the power off completely, unplug the AC power cord.



To prohibit disc ejection

On the front panel ONLY:

- 1 Press **STANDBY/ON ⏻/⏻** (or **AUDIO ⏻/⏻** on the remote control) to turn off the power.
The STANDBY lamp lights up.
- 2 Press and hold **SOURCE** for more than 5 seconds.
"LOCKED" appears on the display for a moment and the disc tray is locked.



To unlock the disc tray, turn off the power, then press and hold **SOURCE** for more than 5 seconds.
"UNLOCKED" appears on the display for a moment and the disc tray is unlocked.

- You can neither lock nor unlock the disc tray while the system is turned on.

Basic Tuner Operations

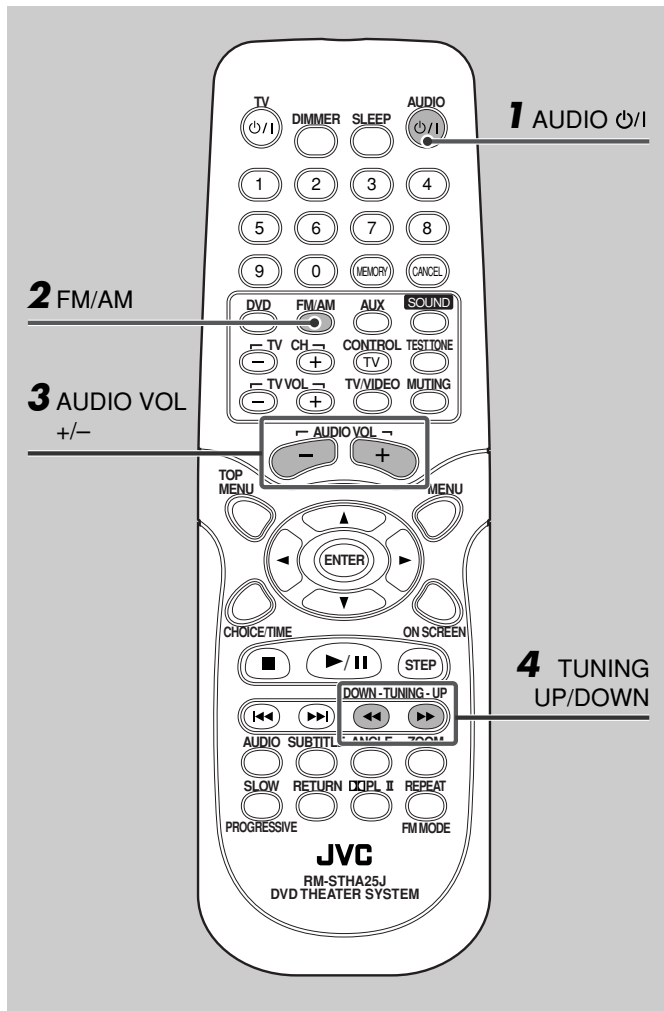

For in-depth information about tuner operations, see “Tuner Operations” on pages 34 and 35.

1 Turn On the Power

Press **AUDIO** (or **STANDBY/ON** on the front panel).
The **STANDBY** lamp goes off.
The source indication selected previously appears on the display.



2 Select the Band

From the remote control:

Press **FM/AM**.

The last received station of the selected band is tuned in.
• Each time you press the button, the band alternates between FM and AM.



On the front panel:

Press **SOURCE** repeatedly until the desired band (FM or AM) appears on the display.

The last received station of the selected band is tuned in.

- Each time you press the button, the source changes as follows:



3 Adjust the Volume

From the remote control:

To increase the volume, press and hold **AUDIO VOL +**.

To decrease the volume, press and hold **AUDIO VOL -**.



On the front panel:

To increase the volume, turn **VOLUME** control clockwise.

To decrease the volume, turn **VOLUME** control counterclockwise.

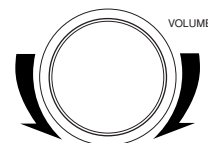

4 Tune into a Station

From the remote control:

Press and hold **TUNING UP** or **DOWN** until the station frequency starts changing continuously on the display.



The system starts searching for a station.

- When a station of sufficient signal strength is tuned in, the system stops searching, and the **TUNED** indicator lights up on the display.

On the front panel:

- 1 Press so that “**MANUAL**” appears on the display.
- 2 Press and hold or until the station frequency starts changing continuously on the display.
The system starts searching for a station.

Notes:

- When an FM stereo program is received, the **ST** indicator also lights up.
- When you press the button repeatedly, the frequency changes step by step.

To turn off the power (into standby)

Press **AUDIO** (or **STANDBY/ON** on the front panel).

The **STANDBY** lamp lights up.

- A small amount of power is consumed even in standby mode. To turn the power off completely, unplug the AC power cord.



Other Basic Operations

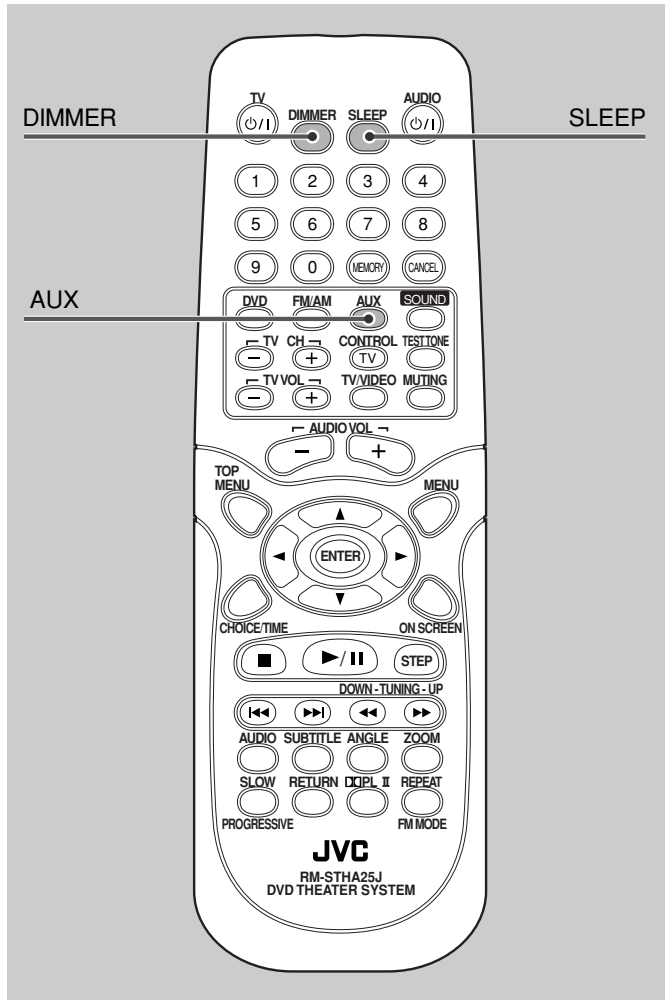

Enjoying Sounds from the External Component

You can enjoy sounds from the external components connected to the AUDIO IN jacks and the DIGITAL IN terminal on the rear panel of the center unit.

1 Select AUX or DIGITAL IN as the source.

From the remote control:

Press **AUX**.

- Each time you press the button, the source changes as follows:

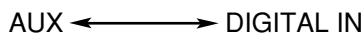

On the front panel:

Press **SOURCE** repeatedly until “DIGITAL IN” or “AUX” appears on the display.



DIGITAL IN: select this to enjoy the external component connected to DIGITAL IN terminal.

AUX: select this to enjoy the external component connected to AUDIO IN jacks.

2 Start playback on the external component.

- For in-depth information about the external component, see the manual supplied with it.

Notes:

- When “DIGITAL IN” is selected as the source and the Dolby Digital or DTS multi-channel signal is detected, Multichannel Surround is activated automatically. For in-depth information about Multichannel Surround, see “Surround Mode Introduction” on page 19.
- You can enjoy Dolby Pro Logic II mode when you playback any 2-channel sources, either digital or analog. For in-depth information about Dolby Pro Logic II modes, see “Surround Mode Introduction” on page 19.

Turning Off the Power with the Timer

You can fall asleep while listening to music—Sleep Timer.

From the remote control ONLY:

Press **SLEEP**.

“SLEEP” and the shut-off time appear on the display.

- Each time you press the button, the shut-off time changes as follows:

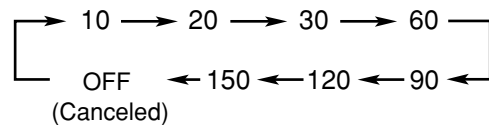

When the shut-off time comes, the system turns off automatically.

To check or change the time remaining until the shut-off time

Press **SLEEP** once.

The remaining time (in minutes) appears on the display.

- By pressing **SLEEP**, you can change the shut-off time.

To cancel the Sleep Timer

Press **SLEEP** repeatedly until “OFF” appears on the display.

- Turning off the power also cancels the Sleep Timer.

Adjusting the Display Brightness

You can dim the display.

From the remote control ONLY:

Press **DIMMER**.

- Each time you press the button, the brightness level of the display changes as follows:

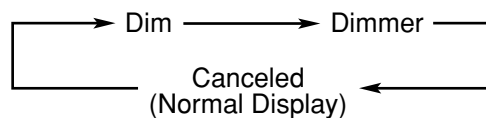

Creating Realistic Sound Fields

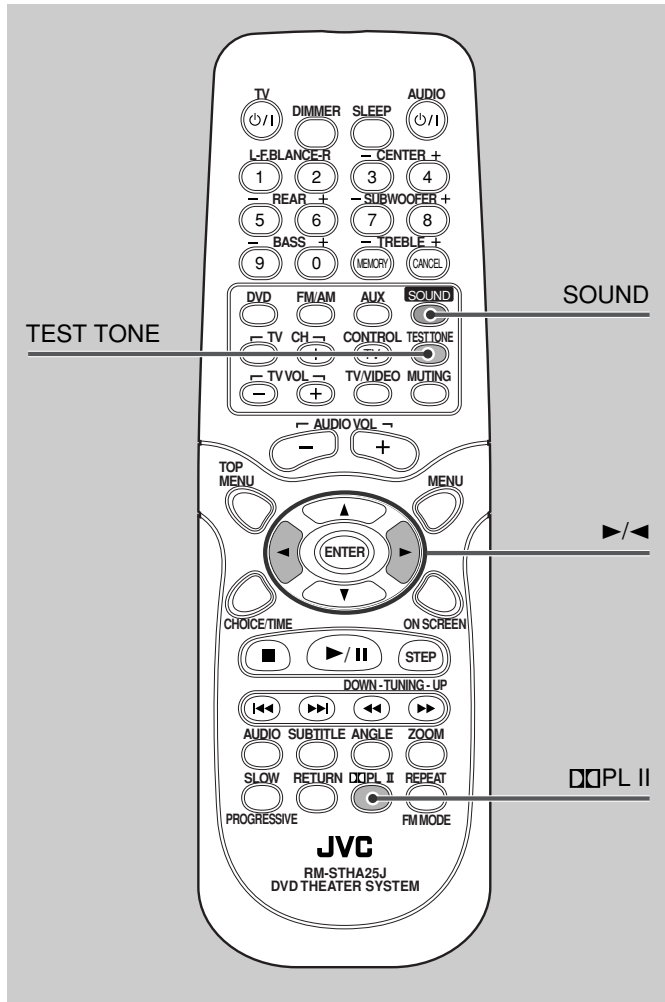

Using the Test Tone

You can check whether each speaker is connected properly.

From the remote control ONLY:

1 Press **DOLBY II** repeatedly to activate all the speakers.

The audio channel indicators light up on the display as follows when all the speakers are activated:

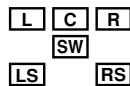

- You can also activate all the speakers by loading a digital multichannel disc.

2 Press **TEST TONE**.

The test tone comes out of the speakers in the following order:

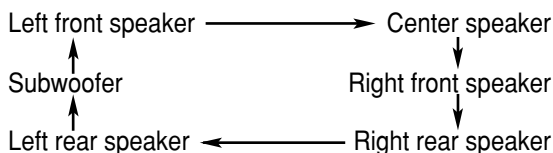

To adjust speaker output level

You can adjust the output level of the center speaker, rear speakers, and subwoofer while listening to the test tone.

Press **▶/◀** while the test tone is coming out of the speaker you want to adjust.

The speaker output level appears on the display.

▶: Increases the output level (to +06 dB).

◀: Decreases the output level (to -06 dB).

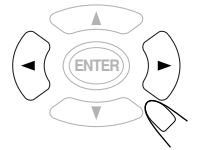

To stop the test tone, press **TEST TONE** again.

Notes:

- You cannot use this function while playing back a disc. Stop the disc playback to use this function when the source is DVD/CD.
- If no sounds come out of a speaker, check the speaker's connection (see pages 6 and 7).
- You cannot adjust the output level of rear speakers separately. See "Adjusting the Sound" below to adjust the balance of rear speakers.

Adjusting the Sound

You can adjust the sound balance and the tone.

It is recommended to turn on your TV and make adjustments from your actual listening point.

You can adjust the following settings:

Balance	FRONT BALANCE:	To adjust the output balance for the front speakers (from -00 to -06, OFF*).
	REAR BALANCE:	To adjust the output balance for the rear speakers (from -00 to -06, OFF*).
Output level	CEN LEVEL:	To adjust the output level of the center speaker (from -06 dB to +06 dB).
	REAR LEVEL:	To adjust the output level of the rear speakers (from -06 dB to +06 dB).
	S/W LEVEL:	To adjust the output level of the subwoofer (from -06 dB to +06 dB).
Tone	BASS:	To adjust the output level of the bass tone (from -10 dB to +10 dB, at 2 dB step).
	TREBLE:	To adjust the output level of the treble tone (from -10 dB to +10 dB, at 2 dB step).
Delay	C-DLY:	To adjust delay time for the center speaker when the digital multichannel surround is activated (from 0 msec to 5 msec).
	R-DLY:	To adjust delay time of the rear speakers for each surround mode.

* When you set to OFF, no sound comes out from the speaker.

Notes:

You can also adjust the output level (**CEN LEVEL**, **REAR LEVEL**, and **S/W LEVEL**) while using the test tone. See "Using the Test Tone" on the left column.

Creating Realistic Sound Fields

Basic sound adjustment procedure

Ex. : To adjust the front speaker balance

From the remote control ONLY:

1 Play the disc you want to use for the sound adjustment.

2 Press **SOUND** repeatedly until “**FRONT BALANCE**” and the adjustment bar appear on the TV screen.

Each time you press the button, the adjustment indication on the TV screen changes as follows:

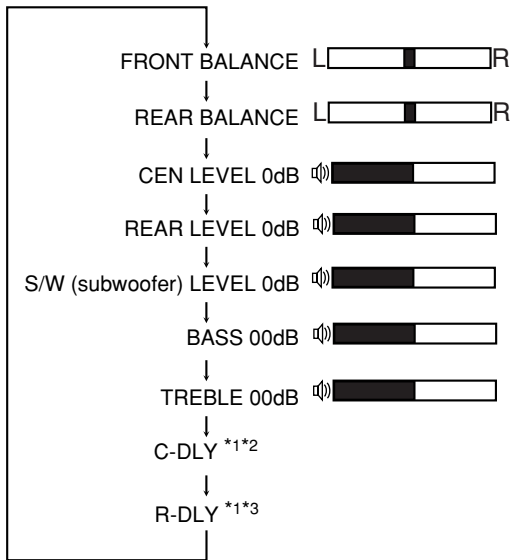

*1: No adjustment bar appears on the TV screen when you adjust the delay time. Refer to the display on the center unit to adjust the delay time.

*2: “C-DLY” is adjustable only when the digital multichannel surround (Dolby Digital or DTS Digital Surround) is activated.

*3: “R-DLY” is adjustable only when the digital multichannel surround or one of Dolby Pro Logic II modes is activated.

There is a time limit in doing the following steps. If the setting is canceled before you finish, press **SOUND** and start from step 2 again.

3 Press **▶** or **◀** to adjust the output balance (–00 to –06, OFF).

▶: Decreases the left speaker output, or restores the right speaker output.

◀: Decreases the right speaker output, or restores the left speaker output.

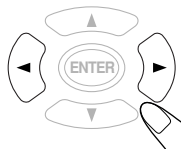

You can also adjust the sound setting referring to the display on the center unit. Refer to the display indication when you want to adjust the sound using sources other than discs.

Sound adjustment indication on the display

Ex.: Front balance

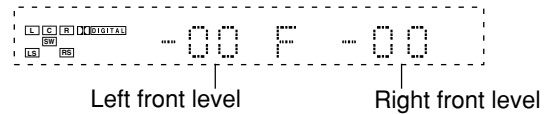

Ex.: Center level

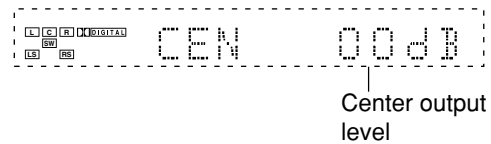

Ex.: Rear delay time

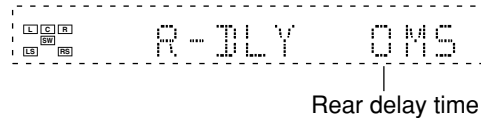

4 Repeat steps 2 and 3 to adjust the other items.

On delay time adjustment

You can adjust and store the delay time setting for each surround mode. Select the surround mode you want to adjust before starting delay time adjustment.

Adjustable range

Digital Multichannel Surround:	C-DLY: 0 msec to 5 msec R-DLY: 0 msec to 15 msec
---------------------------------------	---

Dolby Pro Logic II modes (R-DLY only)

PLII MUSIC:	0 msec to 15 msec
PLII MOVIE:	10 msec to 25 msec
PLII MATRIX:	0 msec to 15 msec
PRO LOGIC:	10 msec to 25 msec

1 msec increase (or decrease) in delay time corresponds to 30 cm increase (or decrease) in distance.

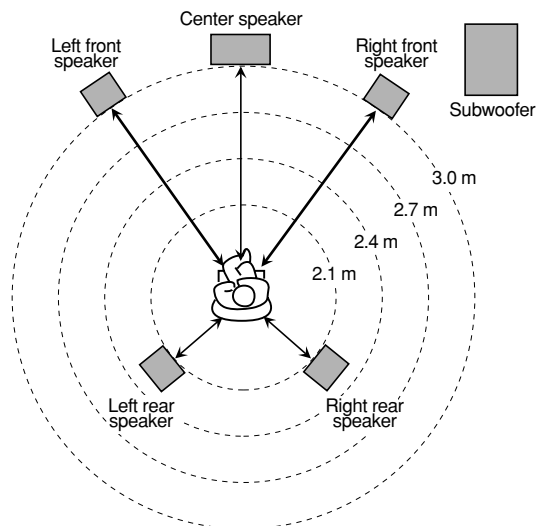

Ex. : In this case, set R-DLY to “3MS”

Surround Mode Introduction

You can use the following surround to reproduce a realistic sound field.

- Multichannel Surround—Dolby Digital and DTS Digital Surround
- Dolby Pro Logic II modes

■ Dolby Digital and DTS Digital Surround

To enjoy surround effectively, all the speakers need to be connected and activated.

Dolby Digital*



Used to reproduce multichannel sound tracks of the software encoded with Dolby Digital ()

Dolby Digital encoding method (so-called discrete 5.1 channel digital audio format) records and digitally compresses the left front channel, right front channel, center channel, left surround channel, right surround channel, and LFE channel signals (total 6 channels, but LFE channel is counted as 0.1 channel. Therefore, called 5.1 channel).

Since each channel is completely independent from the other channel signals to avoid interference, you can obtain much better sound quality with much stereo and surround effects.

When the system detects Dolby Digital signals, the  indicator lights up on the display.

DTS Digital Surround**

Used to reproduce multichannel sound tracks of the software encoded with DTS ( or )

DTS Digital Surround is another discrete 5.1 channel digital audio format available on CD, LD, and DVD software.

Compared to Dolby Digital, audio compression rate is relatively low. This fact allows DTS Digital Surround format to add breadth and depth to the reproduced sounds. As a result, DTS Digital Surround features natural, solid and clear sound.

When the system detects DTS signals, the  indicator lights up on the display.

■ Dolby Pro Logic II modes

Dolby Pro Logic II*

Dolby Pro Logic II is the multichannel playback format to decode any 2 channel (stereo) sources—either digital or analog—into 5.1 channel.

Matrix-based encoding/decoding method for Dolby Pro Logic II makes no limitation for the cutoff frequency of the rear treble and enables stereo rear sound compared to conventional Dolby Pro Logic.

Dolby Pro Logic II enables to reproduce spacious sound from original sound without adding any new sounds and tonal colorations.

Dolby Pro Logic II has four modes—**Music mode**, **Movie mode**, **Matrix mode**, and **Pro Logic mode**:

Pro Logic II Music (PLII MUSIC)—suitable for reproduction of any 2 channel stereo music sources. You can enjoy wide and deep sound by using this mode.

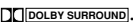
Pro Logic II Movie (PLII MOVIE)—suitable for reproduction of Dolby Surround encoded sources bearing the mark .

You can enjoy sound field very close to the one created with discrete 5.1 channel sounds.

Pro Logic II Matrix (PLII MATRIX)—suitable for reproduction of monaural sources.

Pro Logic (PRO LOGIC)—suitable for reproduction of sources encoded with Dolby Surround.

- When one of Dolby Pro Logic II modes is activated, the  indicator lights up on the display.

* Manufactured under license from Dolby Laboratories. "Dolby," "Pro Logic," and the double-D symbol are trademarks of Dolby Laboratories. Confidential Unpublished Works. ©1992–1997 Dolby Laboratories. All rights reserved.

** "DTS" and "DTS Digital Surround" are registered trademarks of Digital Theater Systems, Inc.

Creating Realistic Sound Fields

Activating the Surround Mode

You can enjoy Digital Multichannel Surround (Dolby Digital and DTS Digital Surround) and Dolby Pro Logic II.

To activate Digital Multichannel Surround

When you start playback a Dolby Digital or DTS multichannel disc, the system detects it and activate Multichannel Surround automatically.

- When Dolby Digital is detected, the **DIGITAL** indicator lights up on the display.
- When DTS Digital Surround is detected, the **dts** indicator lights up on the display.

To activate Dolby Pro Logic II modes

You can use Dolby Pro Logic II when you playback any 2 channel sources, either digital or analog.

Press **PL II**.

The current Pro Logic II mode appears on the display for a while.

- Each time you press the button, Pro Logic II mode changes as follows:

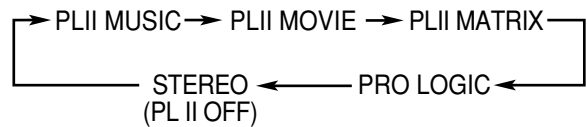

- When one of the Dolby Pro Logic II modes is activated, the **PRO LOGIC II** indicator lights up on the display.

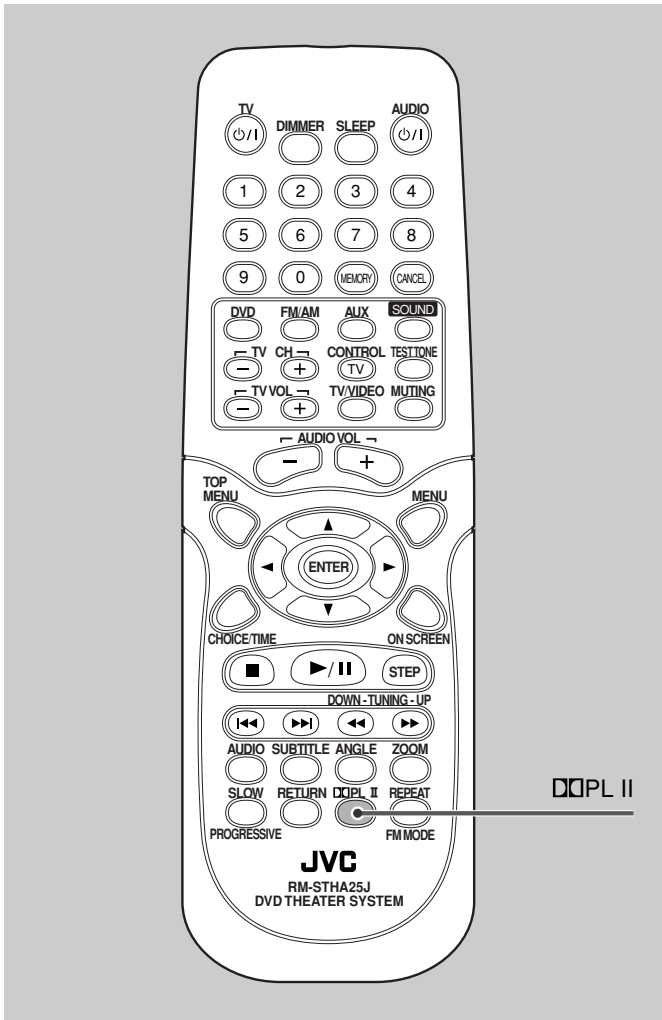

Available surround according to the input signal format

○: Possible ×: Impossible

Surround	Digital Multichannel Surround	Pro Logic II				canceled (STEREO)
		PLII MUSIC	PLII MOVIE	PLII MATRIX	PRO LOGIC	
Analog	×	○	○	○	○	○
Linear PCM	×	○	○	○	○	○
Dolby Digital Multichannel	○	×	×	×	×	×
Dolby Digital 2 ch	×	○*	○*	○*	○*	○*
Dolby Surround	×	○*	○*	○*	○*	○*
DTS Digital Multichannel	○	×	×	×	×	×
DTS 2 ch	×	×	×	×	×	○
MP3	×	○	○	○	○	○

* Some discs have a certain fixed surround mode which cannot be changed.

Disc Introduction—DVD/VCD/SVCD/CD

This system has been designed to play back the following discs: DVD, DVD-R, DVD-RW, Video CD (VCD), Super Video CD (SVCD), Audio CD (CD), CD-R, and CD-RW.

- This system can also play back MP3 and JPEG files recorded on CD-Rs and CD-RWs. For in-depth information about what MP3 and JPEG are, see “MP3/JPEG Introduction” on page 30.

Discs you can play:

Disc Type	Mark (Logo)	Color System	Region Code Number*
DVD Video		NTSC	1 ALL
Video CD			_____
Super Video CD			_____
Audio CD		_____	_____

- On some DVD or VCD/SVCD discs, their actual operations may be different from what is explained in this manual. This is due to the disc programming and disc structure, but not a malfunction of this system.
- DVD-R/RW discs recorded with the DVD VIDEO format can be played back. However, some discs may not be played back because of the disc characteristics or recording conditions. Note that unfinalized disc cannot be played back.
- The following discs cannot be played back:
 - DVD-Audio, DVD-ROM, DVD-RAM, CD-ROM, CD-I, (CD-I Ready), Photo CD, SACD, etc.
 Playing back these discs will generate noise and damage the speakers.

* Note on Region Code

DVD players and DVD have their own Region Code numbers. This system only can play back DVD whose Region Code numbers include “1.”

Examples:



If a DVD with the inadequate Region Code numbers is loaded, “REGION ERR” appears on the display and playback cannot start.

IMPORTANT: Before performing any operations, make sure of the following....

- Check the connection with the TV.
- Turn on the TV and select the correct input on the TV to view the pictures or on-screen indications on the TV screen.
- For DVD playback, you can change the Setup menu setting to your preference. (See pages 38 to 40.)

If “” appears on the TV screen when pressing a button, the disc cannot accept an operation you have tried to do, or information required for that operation is not recorded in the disc.
NOTICE : In some cases, without showing “,” operations will not be accepted.

Disc structure—DVD, Video CD (VCD/SVCD) and Audio CD (CD)

A DVD consists of **Titles**, and each title may be divided into some **Chapters**. (See Example 1.)

For example, if a DVD contains some movies, each movie may have its own title number, and it may be further divided into some chapters.

On the other hand, a VCD/SVCD/CD consists of **Tracks**. (See Example 2.)

In general, each song has its own track number. (On some discs, each track may also be divided by Indexes.)

When playing back a VCD/SVCD with Playback Control (PBC) function, you can select what to view using the menu shown on the TV screen. (While operating a VCD/SVCD using the menu, some of the functions such as Repeat and Track Search may not work.)

Example 1: DVD

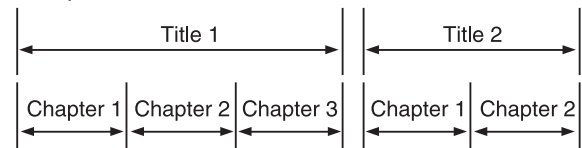

Example 2: VCD/SVCD/CD

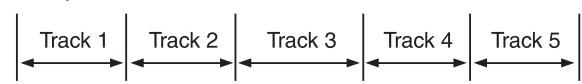

Notes on CD-R and CD-RW

User-edited CD-Rs (Recordable) and CD-RWs (Rewritable) can be played back only if they are already “**finalized**.”

- The system can play back CD-Rs or CD-RWs recorded on a personal computer if they have been recorded in the VCD/SVCD format, audio CD format, MP3 format, and JPEG format (see page 30). However, they may not be played back depending on their characteristics or recording conditions.
- Before playing back CD-Rs or CD-RWs, read their instructions or cautions carefully.
- Some CD-Rs or CD-RWs may not be played back on this system because of their disc characteristics, damage or stain on them, or if the built-in lens is dirty.
- CD-RWs may require a longer readout time. This is caused by the fact that the reflectance of CD-RWs is lower than for regular CDs.

This product incorporates copyright protection technology that is protected by method claims of certain U.S. patents and other intellectual property rights owned by Macrovision Corporation and other rights owners. Use of this copyright protection technology must be authorized by Macrovision Corporation, and is intended for home and other limited viewing uses only unless otherwise authorized by Macrovision Corporation. Reverse engineering or disassembly is prohibited.

Disc Playback

You can only use the remote control for the operations in this “Disc Playback” section.

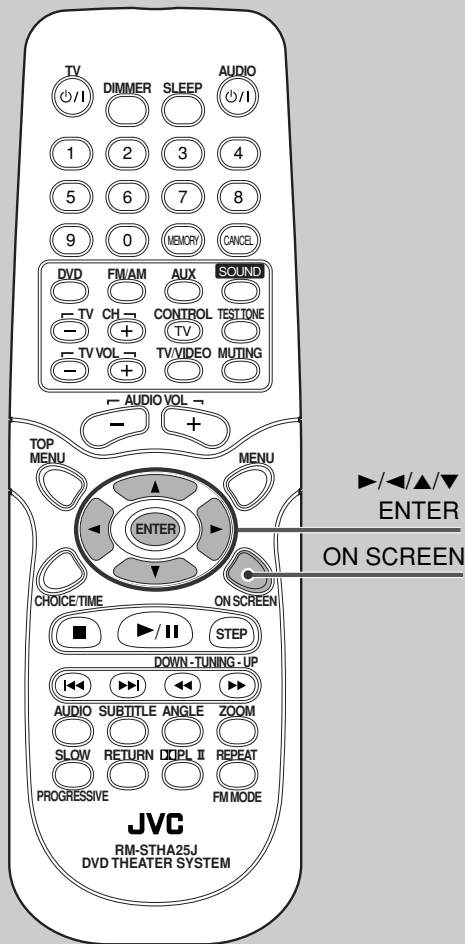

- For basic disc operations such as inserting a disc, starting playback, and moving to another chapters/tracks, see “Basic Disc Operations” from pages 12 to 14.
- shows which types of disc are supported for the operations explained in each section.

Some discs contain several audio languages, subtitles, and multi-angle views. When you find the following marks on the disc or its package, you can select these elements recorded on the disc.

	Subtitles are recorded on the disc. The number inside the mark indicates the total number of the recorded subtitles.
	Several audio languages are recorded on the disc. The number inside the mark indicates the total number of the recorded audio languages.
	Multi-angle views are recorded on the disc. The number inside the mark indicates the total number of the recorded multi-angle views.

If you cannot find out whether your disc contains these features listed above, you can check it by showing the on-screen bar.

Using the On-Screen Bar



You can check the following information on a disc while the disc is loaded, and you can use some functions through the on-screen bar.

■ Showing the On-Screen Bar

From the remote control ONLY:

Press ON SCREEN.

- Each time you press the button, the following on-screen bar appears on the TV screen in sequence.



• DVD

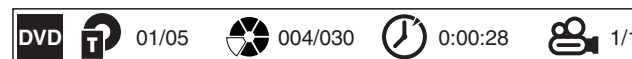

The on-screen bar disappears

• SVCD



The on-screen bar disappears

• VCD/CD



The on-screen bar disappears

* icon appears when you play back a VCD.

Notes:

DVD and SVCD on-screen bar consist of two pages. You can also press **▶** repeatedly to select next page instead of pressing ON SCREEN.

Contents of the on-screen bar

<ul style="list-style-type: none"> • : Disc Type icon
<ul style="list-style-type: none"> • : Title icon Shows current title and total number of the titles on the disc.
<ul style="list-style-type: none"> • : Chapter icon Shows current chapter and total number of the chapters in the current title.
<ul style="list-style-type: none"> • : Track icon Shows current track and total number of the tracks on the disc.
<ul style="list-style-type: none"> • : Time icon Shows the elapsed playing time or remaining time. See page 25.
<ul style="list-style-type: none"> • : Multi-angle icon Shows current angle and total number of the angle views in the scene. See page 25.
<ul style="list-style-type: none"> • : Audio language icon Shows current audio language and total number of languages in the current chapter or track. See page 24.
<ul style="list-style-type: none"> • : Sound signal icon (Ex.: Dolby Digital) When the sound signal is Dolby Digital or DTS, the sound signal icon appears.
<ul style="list-style-type: none"> • : Subtitle language icon Shows current subtitle language and total number of languages in the current chapter or track. See page 24.
<ul style="list-style-type: none"> • : Sound channel icon Shows current output sound channel. See page 25.
<ul style="list-style-type: none"> • : Repeat mode icon Shows current Repeat Play mode. See page 28.

Basic operation through the On-Screen Bar

See the corresponding pages for details of each function.

Ex.: To select “ TITL (Repeat Title)” for the repeat mode during DVD play.

1 Press ON SCREEN.

The following on-screen bar appears on the TV screen.

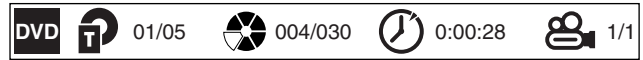

2 Press / repeatedly to select “ OFF.”

The color of the icon changes when selected.

- Each time you press the button, the selected icon changes one after another.

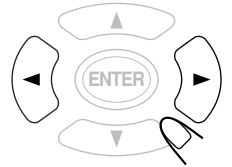

3 Press / repeatedly to select the desired option.

- Each time you press the button, the options change.

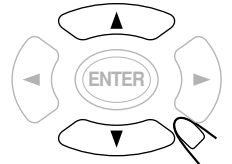

4 Press ENTER.

The setting changes.



5 Press ON SCREEN.

The on-screen bar disappears.



Disc Playback

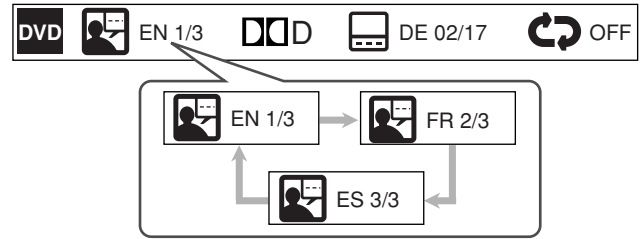
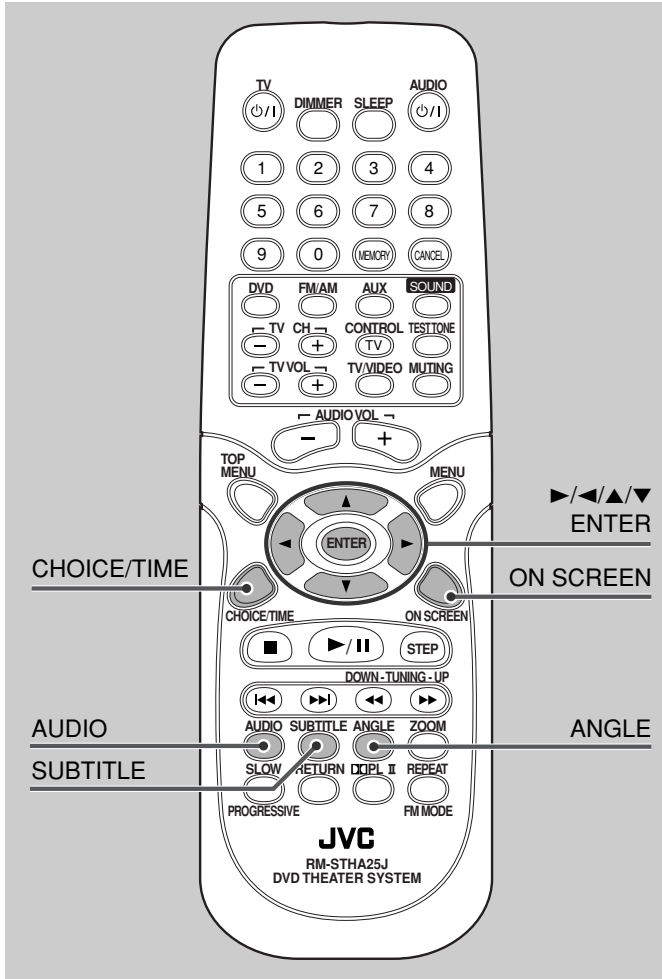

Ex.: When the DVD has 3 audio languages—English (EN), French (FR), and Spanish (ES).

4 Press ENTER.

The setting changes.



5 Press ON SCREEN.

The on-screen bar disappears.



Notes:

Language names are not appear on the on-screen bar when you play back an SVCD.

To change the DVD audio language with one button

Press AUDIO.

- Each time you press the button, the audio language changes as follows:

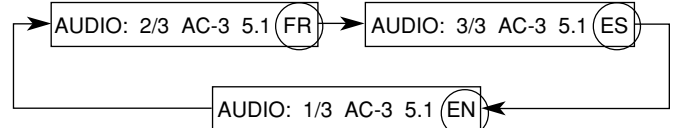

Ex.: When the DVD has 3 audio languages—English (EN), French (FR), and Spanish (ES).

Selecting the Audio Languages

DVD SUPER VCD

While playing back a DVD/SVCD containing audio languages (sound track), you can select the language (sound track) to listen to.

- You can set your favorite audio language as the initial audio language (for DVD only). (See page 38.)

1 Press ON SCREEN.

The on-screen bar appears on the TV screen.



2 Press ►/◄ repeatedly to select

“.”

The color of the icon changes when selected.

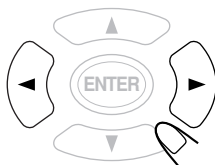

3 Press ▲/▼ repeatedly to select the desired language.

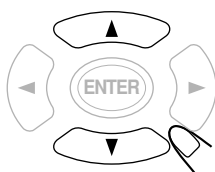

Selecting the Subtitles

DVD

While playing back a DVD containing subtitles in different languages, you can select the subtitle to be displayed on the TV screen.

- You can set your favorite subtitle language as the initial language shown on the screen. (See page 38.)

Press SUBTITLE.

The on-screen bar appears on the TV screen for a while.

- Each time you press the button, the subtitle language changes as follows:

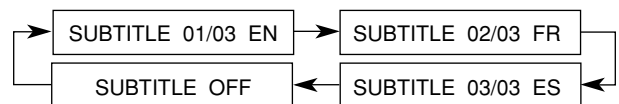

Ex.: When the DVD has 3 selections—English, French, Spanish and no subtitle (OFF)

Notes:

You can also change the subtitle by using the on-screen bar.

Selecting the Playback Channel

VIDEO CD SUPER VCD AUDIO CD

When you play back a karaoke VCD/SVCD or CD, you can select the left channel or right channel to listen to.

Press **AUDIO** repeatedly.

- Each time you press the button, the sound mode changes as follows:

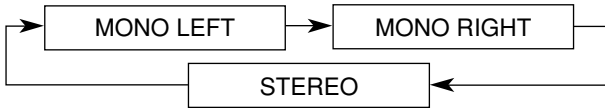

- MONO LEFT:** Select this to listen to the left channel sound.
- MONO RIGHT:** Select this to listen to the right channel sound.
- STEREO:** Select this to listen to both channel sounds.

REMEMBER to select "STEREO" to restore normal stereo playback after playing back a karaoke VCD/SVCD or CD using "MONO LEFT" or "MONO RIGHT."

Notes:

- You can also change the playback channel by using the on-screen bar.
- This function does not work on a DTS CD though the mode indication appears and changes.

Selecting the Multi-Angle Views

DVD

While playing back a DVD containing multi-angle views, you can view the same scene at different angles.

- When you play back the DVD containing multi-angle views, appears on the TV screen.

From the remote control ONLY:

Press **ANGLE**.

- Each time you press the button, the view angle changes.

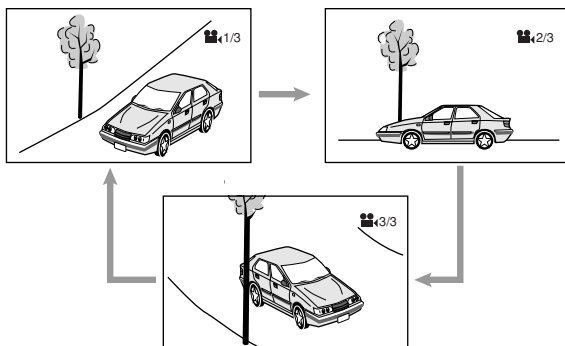

Ex.: When the disc has 3 multi-angle views

Notes:

- You can also change the view angle by using the on-screen bar.
- When the on-screen bar is shown on the TV screen, Multi-angle view indication also changes as follows:

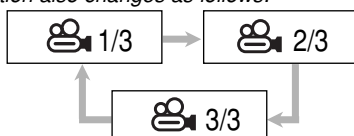

- You cannot change the view angle in the chapter where does not appear even if the on-screen bar indicate multi-angle view (the on-screen bar shows the number of angles contained in the current title, not chapter).

Checking the Remaining Time

DVD VIDEO CD SUPER VCD AUDIO CD

While playing back a disc, you can check the remaining time.

From the remote control ONLY:

Press **CHOICE/TIME** during play.

The on-screen bar and the current playing time indication appear on the TV screen.



- Each time you press the button, the following indication appears on the TV screen:

For DVD

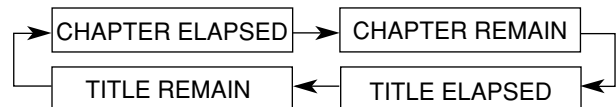

TITLE ELAPSED:

Select this to show the elapsed playing time of the current title.

TITLE REMAIN:

Select this to show the remaining time of the current title.

CHAPTER ELAPSED:

Select this to show the elapsed playing time of the current chapter.

CHAPTER REMAIN:

Select this to show the remaining time of the current chapter.

For VCD/SVCD/CD

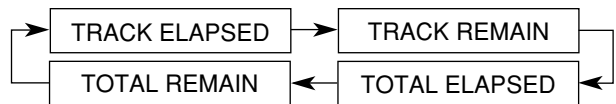

TRACK ELAPSED:

Select this to show the elapsed playing time of the current track.

TRACK REMAIN:

Select this to show the remaining time of the current track.

TOTAL ELAPSED:

Select this to show the total elapsed playing time of the disc.

TOTAL REMAIN:

Select this to show the total remaining time of the disc.

Disc Playback

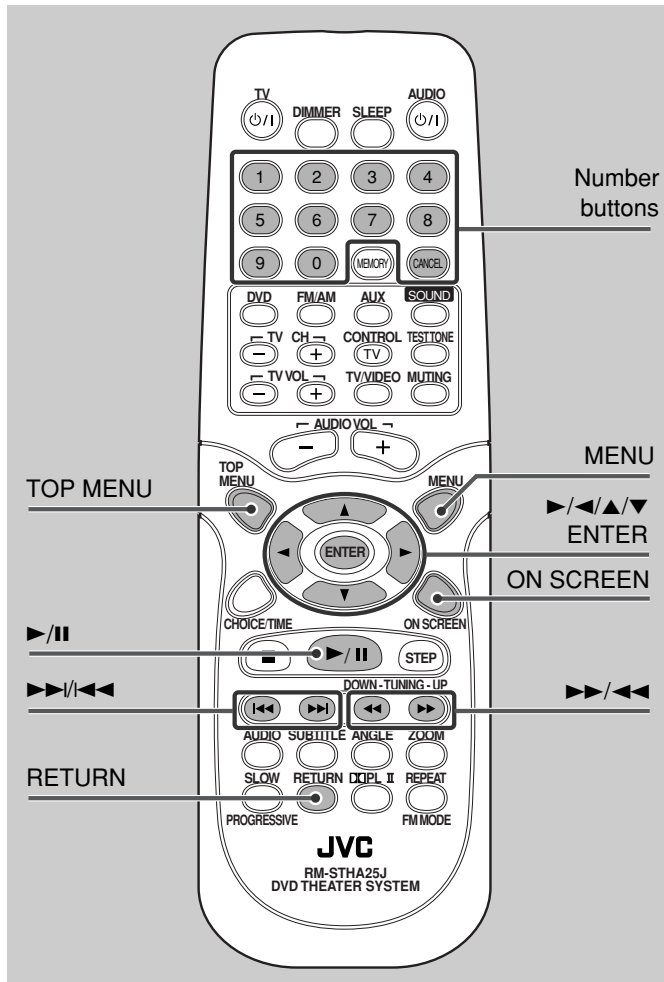

For VCD/SVCD

Some VCDs and SVCDs have menus for interactive operations or a contents search function. The Play Back Control function (PBC) allows you to operate the VCD/SVCD using such menus. When you start playing a VCD/SVCD with PBC function, a menu will automatically appear on the TV screen. ("MENU" will also appear on the display.)

- Some VCDs or SVCDs with PBC function do not show menus automatically. This is due to their disc structures.
- A menu may be a list of items, divided screens, or some moving pictures. See "PBC operation concept" below.

When a menu appears, you can select a desired item on the menu.

- When a list of items is displayed on the TV screen, press the number buttons to select an item.
- When "▶" or "SELECT" is displayed on the TV screen, press ▶/|| to start playback.

To go to the next submenu

Press ▶▶.



To return to the previous submenu

Press ◀◀.



To cancel the PBC playback

You can cancel the menu-driven operations (PBC function):

- 1 Press ■ to stop playback.
- 2 Press the number buttons to select a track, then press ENTER. Normal playback starts from the selected track.

- You can also turn on and off the PBC function by pressing MENU on the remote control. Each time you press the button, the PBC function turns on and off.



Disc Menu-Driven Playback

DVD VIDEO CD SUPER VCD

For DVD

Disc menu-driven playback is possible while playing back a DVD with menu (the menu may consist of still pictures or moving pictures depending on the disc).

- When operating a DVD using the DVD menu, refer also to the instructions supplied for the DVD.

DVD generally have their own menus or title lists. A menu usually contains various information about the disc and playback selections. On the other hand, a title list usually contains titles of movies and songs recorded.

From the remote control ONLY:

1 Press MENU or TOP MENU.

A menu or title list will appear on the TV screen.

"MENU" appears on the display.

- On some DVDs, a menu will automatically appear on the screen after playback starts.



2 Select a desired item on the menu or on the title list, using ▶/◀/▲/▼ and ENTER.

The unit starts playback of the selected item.

- On some DVDs, you can also select items by pressing the number buttons corresponding to the item numbers listed.

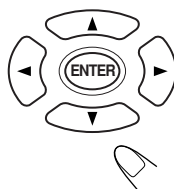

PBC operation concept

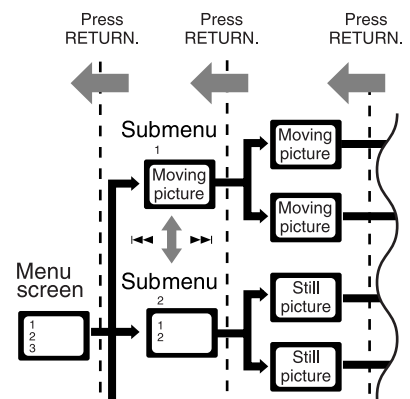

Notes:

While operating a VCD/SVCD using menu, some of the functions such as repeat play may not work.

Moving to a Particular Portion Directly

DVD VIDEO CD SUPER VCD AUDIO CD

You can move to another title, chapter, track, or particular portion in the chapter/title (DVD) or the disc (CD/VCD/SVCD) directly.

From the remote control ONLY:

1 Press ON SCREEN.

The on-screen bar will appear on the TV screen.



2 Press ►/◄ to select one of the icons below.

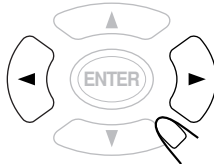

For DVD

- : Select this to move to another title.
- : Select this to move to another chapter.
- : Select this to move to a particular portion.
 - You can input the chapter elapsed time when the on-screen bar shows the chapter elapsed/remaining time. While the title elapsed/remaining time is shown, you can input the title elapsed time. See “Checking the Remaining Time” on page 25 to change the time indication.

For VCD/SVCD/CD

- : Select this to move to another track.
- : Select this to move to a particular portion.
 - You can only input the total elapsed time of the disc even if the track elapsed/remaining time is shown.

3 Press the number buttons to select a desired title, chapter, track, or playing time, then press ENTER.

The system starts playback of the selected item.

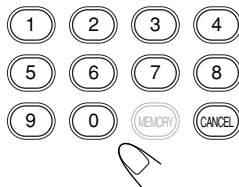

How to input the title, chapter and track number

Select the title/chapter/track number with the number buttons, then press ENTER to start playback.

- To select number 5, press 5.
- To select number 12, press 1, 2.
- To select number 22, press 2, 2.

About 3 seconds after you pressed number buttons, playback starts automatically from the selected title/chapter/track without pressing ENTER.

How to input the playing time

Press the number buttons to input the playing time, then press ENTER to start playback from the selected elapsed playing time.

- To input time “00:45:23,” press 4, 5, 2, 3.
- To input time “01:23:45,” press 1, 2, 3, 4, 5.
- To cancel a mis-entry, press CANCEL.

Each time you press the button, the last entry will be erased.

About 3 seconds after you pressed number buttons, playback starts automatically from the selected time without pressing ENTER.

Notes:

- You can also select a desired title, chapter or track by using ▲/▼ in step 3.
- You can move to another track directly by simply pressing the corresponding number buttons, then ENTER while playing back a CD/ VCD/SVCD (you can skip steps 1 and 2).
- Some DVDs reject the playing time input. This is due to their disc structures, and not a malfunction.

Searching for a Particular Point

DVD VIDEO CD SUPER VCD AUDIO CD

You can search for a particular point while playing a disc—Variable Speed Forward/Reverse Search.

- No sound comes out during Variable Speed Forward/Reverse Search except for CD double-speed search.
- Normal playback begins automatically when playback moves to the next or previous title/track.

To fast-forward the chapter/track—Variable Speed Forward Search

From the remote control ONLY:

Press ►► during playback or pause.

- Each time you press the button, the search speed changes and is shown on the TV screen as follows:

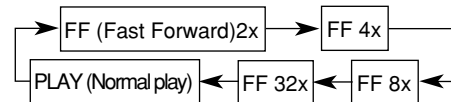

To reverse the chapter/track—Variable Speed Reverse Search

From the remote control ONLY:

Press ◄◄ during playback or pause.

- Each time you press the button, the search speed changes and is shown on the TV screen as follows:



To resume normal play

Press ►/||.



Notes:

The displayed search speed is an approximate value.

Disc Playback

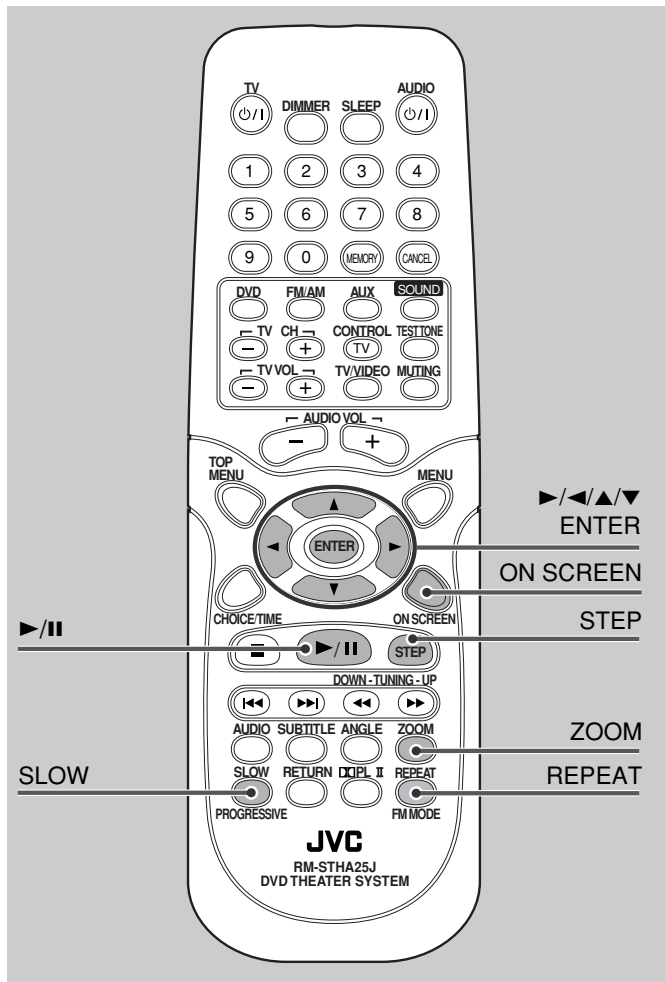

For VCD/SVCD/CD

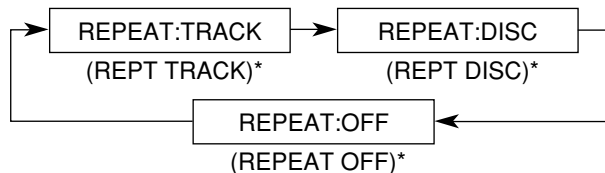

* appearing on the display

REPEAT:TRACK: Current track will be repeated.

REPEAT:DISC: All the disc will be repeated.

REPEAT:OFF: Repeat play is canceled. (Normal play is resumed.)

To cancel Repeat Play

Press REPEAT repeatedly to select “REPEAT:OFF”

■ A-B Repeat

During playback, you can also select a portion you want to repeat.

- A-B repeat is not performed between different titles.
- An interval of more than 5 seconds is required between point A and point B.

Example:

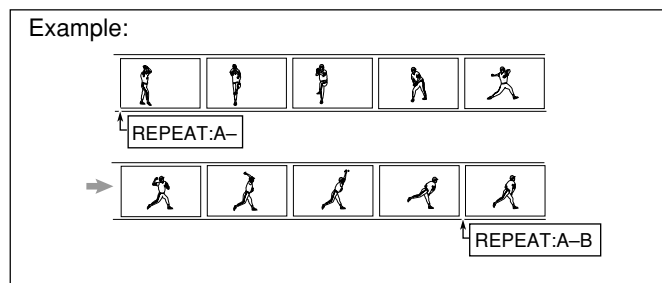

Repeating Playback

DVD VIDEO CD SUPER VCD AUDIO CD

During the VCD playback using the PBC function, you can only use the A-B repeat function.

■ Repeat Play

From the remote control ONLY:

Press REPEAT repeatedly to select the repeat mode.

The repeat mode appears on the TV screen and the display.

- Each time you press the button, the repeat mode changes as follows:

For DVD

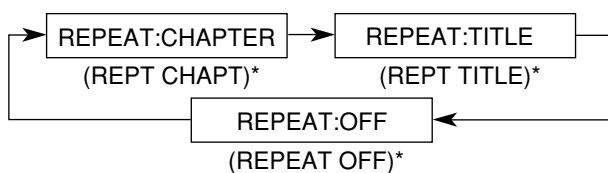

* appearing on the display

REPEAT:CHAPTER: Current chapter will be repeated.

REPEAT:TITLE: Current title will be repeated.

REPEAT:OFF: Repeat play is canceled. (Normal play is resumed.)

From the remote control ONLY:

1 Press ON SCREEN.

The on-screen bar will appear on the TV screen.



2 Press ►/◀ to select the repeat mode icon “⌂” on the on screen bar.

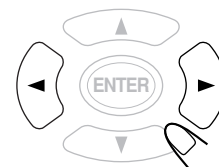

3 Press ▲/▼ repeatedly to select “⌂ A-”

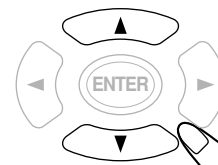

4 Press ENTER to select the start point.

“REPEAT A-” appears on the display and “⌂ A-” changes to “⌂ A-?” on the on-screen bar.



5 Press ENTER again to select the end point.

“REPEAT A-” changes to “REPEAT A-B” and “⌂ A-?” changes to “⌂ A-B,” then A-B repeat begins.

The unit automatically locates point A and starts repeated playback between points A and B.



To cancel A-B Repeat

Press ▲/▼ to select “⏪ OFF” in step 3, then press ENTER.

“REPEAT A-B” disappears from the display and “REPEAT:OFF” appears on the TV screen.

On some DVDs, A-B Repeat may not be used even within the same title. This is due to their disc structures, and not a malfunction of the unit.

Special Picture Playback

DVD VIDEO CD SUPER VCD

■ Still Picture/Frame-by-Frame Playback

You can advance the motion picture frame by frame.

From the remote control ONLY:

1 Press STEP once during playback.

Playback is paused and “STEP” appears on the TV screen.

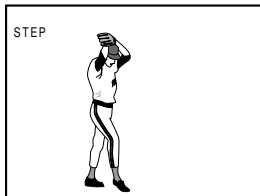

2 Press STEP repeatedly to advance the picture frame by frame.

• Each time you press the button, the picture advances frame by frame.



To resume normal play

Press ►/II.

■ Slow Motion Playback

You can enjoy slow motion playback while playing a DVD, VCD, or SVCD.

From the remote control ONLY:

Press SLOW repeatedly during playback or pause.

• Each time you press the button, slow motion speed changes and is shown on the TV screen as follows:



For DVD:

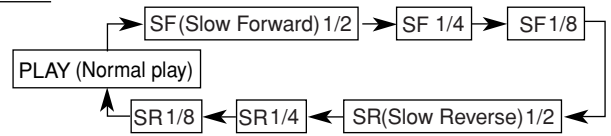

For SVCD/VCD:

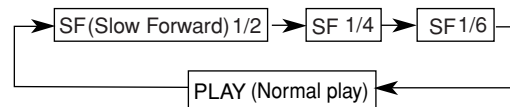

Notes:

Reverse slow playback does not work with SVCD/VCDs.

■ Zoom

You can zoom in on the picture while playing back a DVD, VCD, or SVCD.

From the remote control ONLY:

1 Press ZOOM.

The zoom indicator and “SELECT ZOOM POSITION” appears on the TV screen.

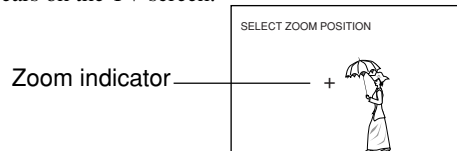

2 Press ►/◀/▲/▼ to move the area you want to watch.

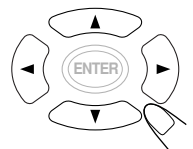

3 Press ENTER.

• Each time you press the button while the indication appears, the magnification changes as follows:

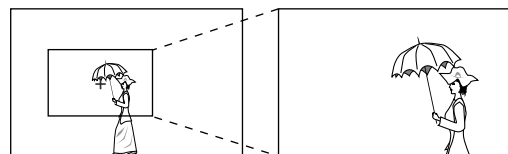
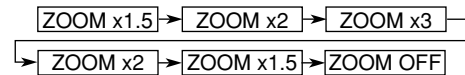

• You can move the zoomed area with pressing ►/◀/▲/▼ repeatedly.

To cancel the ZOOM

Press ZOOM again.

Notes:

You cannot zoom a JPEG picture.

MP3/JPEG Introduction

This system is incorporated with an MP3 decoder and JPEG decoder. You can play back MP3 tracks (files) and JPEG files recorded on CD-Rs and CD-RWs.

- Notice that “files” and “tracks” are used interchangeably in the MP3 explanation.

Notes:

This system can play back a disc containing both MP3 and JPEG files.

What is MP3?

MP3 is an abbreviation of Motion Picture Experts Group (or MPEG) Audio Layer 3. MP3 is simply a file format with a data compression ratio of 1:10 (128 Kbps*). That means, by using MP3 format, one CD-R or CD-RW can contain 10 times as much data volume as a regular CD can.

* Bit rate is the average number of bits that one second of audio data will consume. The measuring unit used is Kbps (1000 bits per second).

To get a better audio quality, choose a higher bit rate. The most popular bit rate for encoding (recording) is 128 Kbps.

MP3 File Compatibility

- This system can only read MP3 files that are recorded in the format that is compliant with ISO 9660 Level 1 and Level 2, and Joliet.
- The system can read or play MP3 files only with the extension code—“.mp3”.

Disc structure—How are MP3 files recorded and played back?

“MP3 files (tracks)” can be recorded in “directories (or folders),” in PC terminology.

During recording, the files and directories can be arranged in a way similar to arranging files and folder/directories of computer data. “Root” is similar to the root of a tree. Every file and directory can be linked to the root.

In compliance with ISO 9660, the maximum allowable depth of nested directories—so-called “hierarchy”—is 300 (inclusive of the root).

Playback order, files search order, and directory search order of the MP3 files recorded on a disc are determined by the writing (or encoding) application; therefore, playback order may be different from the one you have intended while recording the folders/directories and the files.

Note on MP3 discs

MP3 discs (either CD-R or CD-RW) require a longer readout time. (It differs due to the complexity of the directory/file configuration.)

What is JPEG?

A still-picture data compression system proposed by the Joint Photographic Expert Group, which features small decrease in image quality in spite of its high compression ratio.

Disc structure

On a JPEG disc, each still picture (material) is recorded as a file. Files are usually grouped into a folder. Folders can also include another folders, creating hierarchical folder layers.

- A maximum of 5 000 images can be stored on one CD.
- If there is any type of files other than JPEG files in a folder, those files are also counted in the total number of 5 000.

NOTES on JPEG discs

- JPEG discs (either CD-R or CD-RW) require a longer readout time. (It differs due to the complexity of the directory/file configuration.)
- When making a JPEG disc, select ISO 9660 Level 1, Level 2 or Joliet as the disc format.
- This system supports “multi-session” discs (up to 99 sessions).
- This system cannot play “packet write” discs.
- The system can read or play JPEG files only with the extension code—“.jpg”.
- Some JPEG discs may not be played back because of their disc characteristics or recording conditions.

For in-depth information about a disc to be played back, see “Disc Introduction—DVD/VCD/SVCD/CD” on page 21.

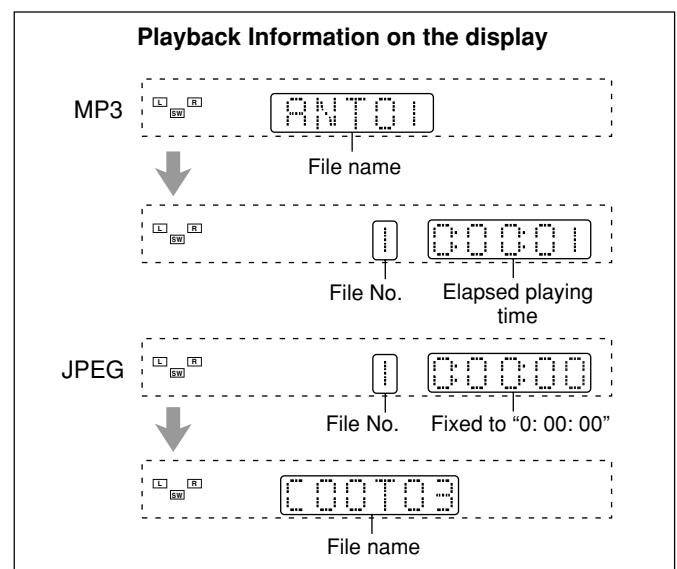

MP3/JPEG Playback

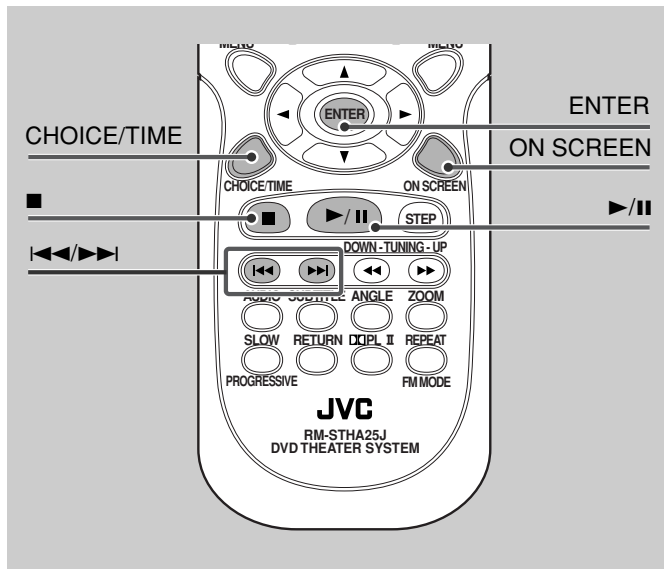

Starting Playback

It is recommended to turn on your TV when playing back MP3 or JPEG files.

Insert a disc.

- After detecting the disc, playback starts automatically.
- The contents recorded on the disc are shown on the TV screen while playing back an MP3 file.
- JPEG files (still pictures) are automatically shown on TV screen one after another with the on-screen bar.
- Press ON SCREEN to show the on-screen bar.

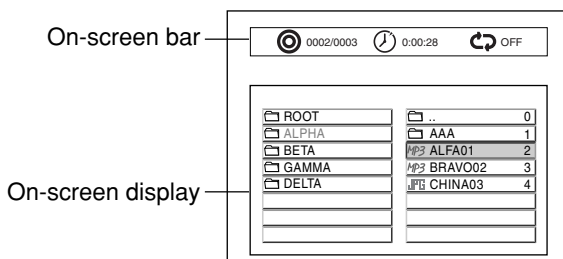

Notes:

- If the loaded disc is recorded in an unplayable format, "WRONG DISC" appears on the display. See also "Disc Introduction—DVD/VCD/SVCD/CD" on page 21 for the disc compatibility.
- The picture size of the JPEG file changes automatically to fit the TV screen.
- You cannot zoom a JPEG picture.

To go to another file

Press ►► or ◀◀ during playback.

- : Skip to the beginning of the next file.
- ◀◀: Skip to the beginning of the current or previous file.



Notes:

It requires a longer time to read out data when playback moves to files in another folder. It is not malfunction. The time varies with the number and type of files in the folder.

To stop playback for a moment

Press ►/||.

The picture stays on the TV screen when you play back a JPEG file.



To resume play, press ►/|| again or ENTER.

To stop during playback

Press ■.

- The picture disappears and the on-screen display appears on the TV screen when you stop playing back a JPEG file.



To remove the disc

Press ▲.

"OPEN" appears on the display and the disc tray comes out.



To close the disc tray, press ▲ again.

Showing the On-Screen Bar

You can show the following information on the TV screen while a disc is loaded.

From the remote control ONLY:

Press ON SCREEN.

- Each time you press the button, the following on-screen bar appears and disappears.



The on-screen bar

①
②
③

①: Current file and total number of the items in the current folder

- Ex.: 1st file is playing out of 3 files in the current folder.

②: Time indicator

Each time you press CHOICE/TIME while playing back MP3 files, the indication changes between the elapsed playing time and the remaining time of the current file. The indication is fixed "0:00:00" when a JPEG file is played back.

③: Repeat mode indicator

You can check the current repeat mode. The indication changes according to the repeat mode as follows:

See "Repeating Playback" on page 33 for the detail of each repeat mode.

MP3/JPEG Playback

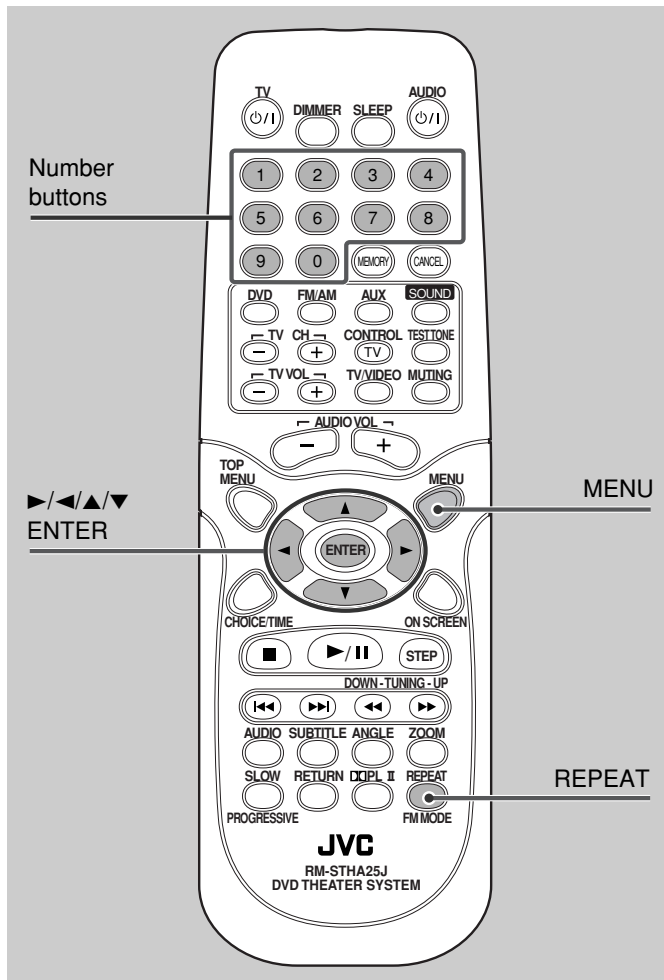

The on-screen display

① : Folder column	• Ex.: 4 folders exist in the current level: ALPHA, BETA, GAMMA, and DELTA.
② : Current folder	The name of the current folder is highlighted.
③ : Content column	The contents of the current folder are shown on this column. • Ex.: 1 folder and 6 or more* files in the current folder. * Only 7 file/folder names can be shown on the column at once. You can scroll the column with ▼/▲ buttons.
④ : Top cells	You can move back to the folder that contains the current folder by selecting the top cell of either column.
⑤ : Current file (Ex.: MP3 file)	The name of the current file is highlighted.
⑥ : Item number	Use this number when you select a particular file or folder with the number buttons.
⑦ : Item type indicator	The item type (folder, MP3 file, or JPEG file) is shown.

Operations Using the On-Screen Display

You can select the file to play back on the on-screen display while playback is stopped.

Notes:

- Only the first 11 letters of the file or folder name appear on the TV screen.
- The file extensions—“.mp3” and “.jpg”—are not displayed.

From the remote control ONLY:

Button	To do
ENTER	Start playback or go into a folder.
▶/◀/▲/▼	Select a file or folder.

To start playback of the selected file

Press ▶/◀/▲/▼ to select the file, then press ENTER.

The system starts playback from the selected file.

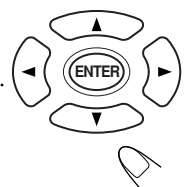

Selecting a Particular File/Folder Directly

You can move to a particular file/folder in the current folder directly.

From the remote control ONLY:

Press the number buttons to select a file/folder number (item number) you want, then press ENTER.

The system starts playback from the selected file.

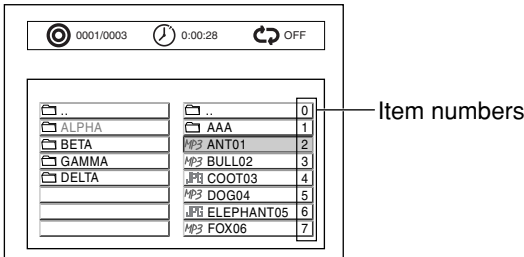

- To select number 5, press 5, then ENTER.
- To select number 10, press 1, 0, then ENTER.
- To select number 23, press 2, 3, then ENTER.
- To select number 123, press 1, 2, 3, then ENTER.

Notes:

When selecting the number of a folder, the contents of the folder appear on the content column.

Repeating Playback

A-B repeat cannot be used when MP3 or JPEG files are played back. You can enjoy only repeat play.

To repeat playback—Repeat Play

From the remote control ONLY:

Press REPEAT repeatedly.

- Each time you press the button, repeat mode changes and appears on the TV screen as follows:

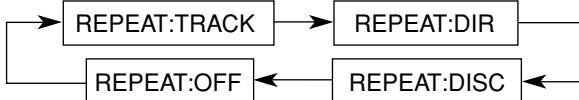

- REPEAT:TRACK:** Current file will be repeated. The picture stand still when playing back a JPEG file.
- REPEAT:DIR:** Files in the current folder (directory) will be repeated.
- REPEAT:DISC:** All files on the disc will be repeated.
- REPEAT:OFF:** Repeat play is canceled. (Normal play is resumed.)

Notes:

You can check the repeat mode with on-screen bar. See "Showing the On-Screen Bar" on page 31 for the detail.

Browsing Pictures in the Current Folder

You can browse pictures in the current folder in smaller size.

JPEG file ONLY:

1 Press MENU.

JPEG files in the current folder are shown on nine windows.



Selected picture

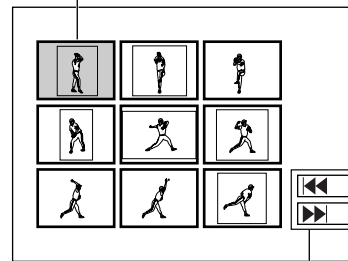

Select to go to the previous page (◀◀) or the next page (▶▶).

2 Press ▶/◀/▲/▼ to select the desired picture, then press ENTER.

Normal playback starts from the file you select.

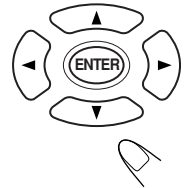

Notes:

- The pictures appearing on the windows at first vary with the picture you have selected or played back before pressing MENU.
- It requires a longer time to show pictures on the windows. The time varies with the number and size of items in the current folder.

Rotating and Flipping a Picture

You can rotate/flip a picture during JPEG file playback.

JPEG file ONLY:

Press ▶/◀/▲/▼.

The picture rotates/flips each time you press the buttons.

- ▶: Rotate the picture 90° clockwise.
- ◀: Rotate the picture 90° counter-clockwise.
- ▲: Flip the picture vertically.
- ▼: Flip the picture horizontally.

Ex.: Flipping a picture

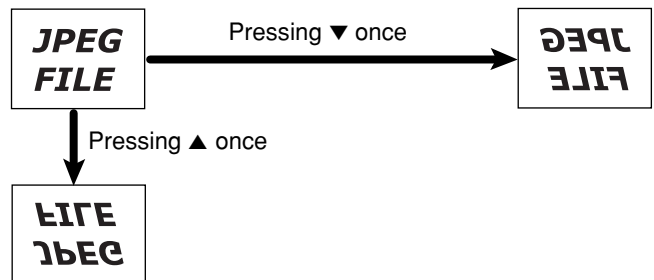

Tuner Operations

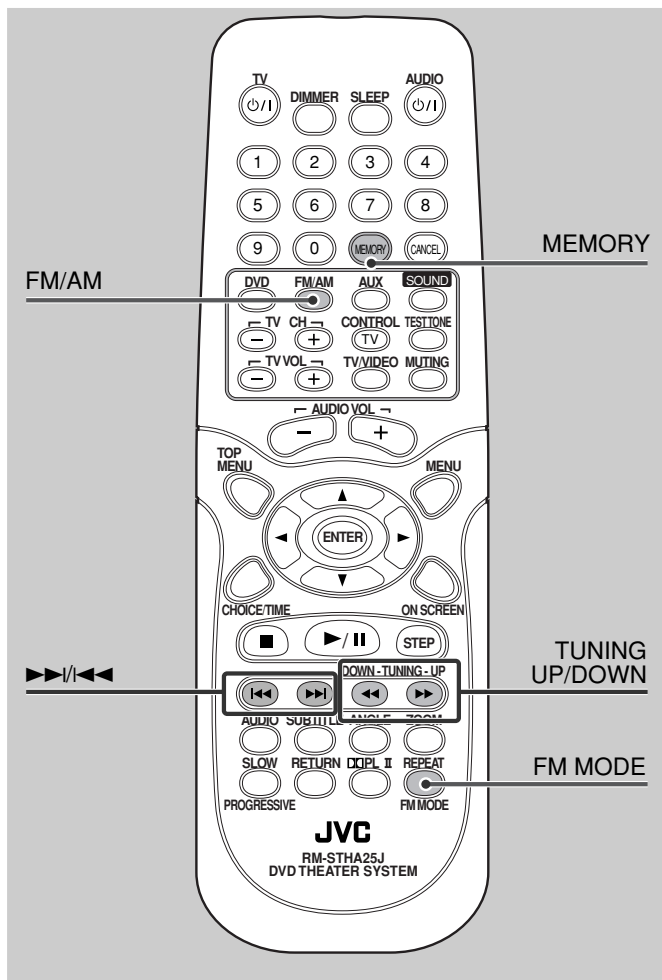

For basic tuner operations, see "Basic Tuner Operations" on page 15.

Tuning in Stations

From the remote control:

1 Press FM/AM repeatedly to select the band.



The last received station of the selected band is tuned in.

- Each time you press the button, the band alternates between FM and AM.

2 Press and hold TUNING UP or DOWN.



- **TUNING UP:** Increases the frequency.
- **TUNING DOWN:** Decreases the frequency.

The system starts searching for stations and stops when a station of sufficient signal strength is tuned in.

- When you press the button repeatedly, the frequency changes step by step.

On the front panel:

1 Press SOURCE repeatedly until the desired band (FM or AM) appears on the display.



The last received station of the selected band is tuned in.

- Each time you press the button, the source changes as follows:

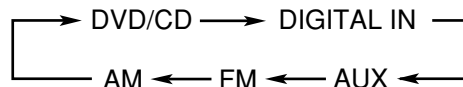

2 Press ■ so that "MANUAL" appears on the display.



- Each time you press the button, the operation mode of ►► and ◀◀ buttons alternates between "PRESET" and "MANUAL."

PRESET: Select this for using ►► and ◀◀ as the buttons to select the preset station.

MANUAL: Select this for using ►► and ◀◀ as the buttons to change the frequency manually.

3 Press and hold ►► or ◀◀.

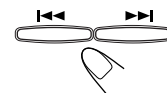

- ►►: Increases the frequency.
- ◀◀: Decreases the frequency.

The system starts searching for stations and stops when a station of sufficient signal strength is tuned in.

- When you press the button repeatedly, the frequency changes step by step.

Notes:

- When a station of sufficient signal strength is tuned in, the **TUNED** indicator lights up on the display.
- When an FM stereo program is received, the **ST** indicator also lights up.

Using Preset Tuning

Once a station is assigned to a channel number, the station can be quickly tuned. You can preset up to 30 FM and 15 AM stations.

To store the preset stations

From the remote control ONLY:

- 1 Tune in the station you want to preset (see “Tuning in Stations”).



There is a time limit in doing the following steps. If the setting is canceled before you finish, start from step 2 again.

- 2 Press MEMORY.

The preset number appears on the display and the PRGM (program) indicator flashes.



Preset number

- 3 Press ►► or ◄◄ to select a preset number.

• Press and hold ►► or ◄◄ to change the preset number continuously.

- 4 Press MEMORY to store the preset station.

The PRGM indicator goes off, and the station is assigned to the selected preset number.

- 5 Repeat steps 1 to 4 until you store all the stations you want.

To erase a stored preset station

Storing a new station on a used number erases the previously stored one.

To tune in a preset station

From the remote control:

- 1 Press FM/AM repeatedly to select the band.

The last received station of the selected band is tuned in.

- Each time you press the button, the band alternates between FM and AM.



- 2 Press ►► or ◄◄ repeatedly until the desired preset station appears on the display.

- ►►: Increases the preset number.
- ◄◄: Decreases the preset number.
- Press and hold ►► or ◄◄ to change the preset number continuously.

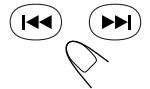

On the front panel:

- 1 Press SOURCE repeatedly until the desired band appears on the display.



- 2 Press ■ so that “PRESET” appears on the display.

• Each time you press the button, the operation mode of ►► and ◄◄ buttons alternates between “PRESET” and “MANUAL.”

PRESET: Select this for using ►► and ◄◄ as the buttons to select the preset station.

MANUAL: Select this for using ►► and ◄◄ as the buttons to change the frequency manually.



- 3 Press ►► or ◄◄ repeatedly until the desired preset station appears on the display.

- ►►: Increases the preset number.
- ◄◄: Decreases the preset number.

- Press and hold ►► or ◄◄ to change the preset number continuously.

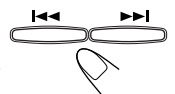

Selecting the FM Reception Mode

When an stereo FM program tuned currently is noisy, you can change the FM reception mode to improve the reception.

From the remote control ONLY:

Press FM MODE.

The **ST** indicator goes off from the display and the program loses the stereo effect.



To resume the stereo effect, press FM MODE again. The stereo effect resumes.

Notes:

Be sure to change the FM reception mode to stereo when you change a station.

Setting Up the DVD Preferences

You can only use the remote control for the setup menu operations.

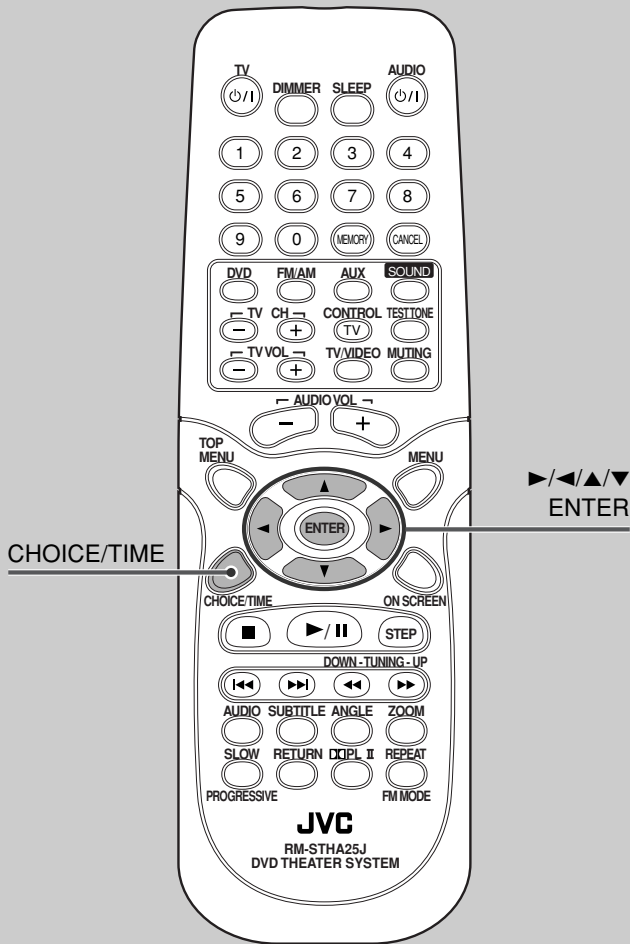

On the setup menu, you can do the two main important settings—system preference (GENERAL SETUP) menu and DVD preference (PREFERENCES) menu.

- Setup menu can only be displayed while a disc is not playing. (The DVD/CD must be selected as the source.)



Setting the System Preferences

You can set the system preferences to match it to your usage and operating circumstances.

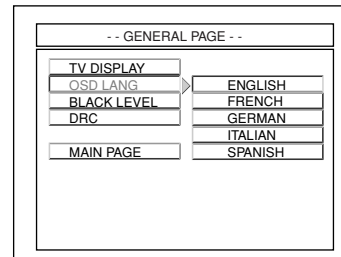
On the general setting menu, you can set the following:



TV DISPLAY: Select the TV screen size for playing back a DVD recorded with 16:9 wide screen video signal.

- **WIDE:** Select “WIDE” when the aspect ratio of the TV is 16:9. (Set the screen size to full on your TV.) 
- **4:3 LB:** Select “4:3 LB (Letter Box)” when the aspect ratio of your TV is 4:3. While viewing a wide screen picture, the black bars appear on the top and the bottom of the screen. 
- **4:3 PS:** Select “4:3 PS (Pan-Scan)” when the aspect ratio of your TV is 4:3. While viewing a wide screen picture, the black bars do not appear, however, the left and right edge sides of the pictures will not be shown on the screen. 

OSD LANG (OSD language): Select the indication language shown on the TV screen while operating the system. (Ex. PLAY, STOP, PAUSE, etc.)

You can select the following languages: English, French, German, Italian, Spanish.

BLACK LEVEL: Select the TV screen brightness.

- ON: Make the screen brightness darker.
- OFF: Make the screen brightness normal.

DRC (Dynamic Range Compression): You can enjoy a powerful sound at night even at a low volume when listening to the sound with Dolby Digital. The higher the tab is set, the deeper the effect becomes.

■ The basic procedure to set up the system preferences

Ex.: To select the TV screen size.

1 Press CHOICE/TIME.

The main page of the setup menu appears on the TV screen.

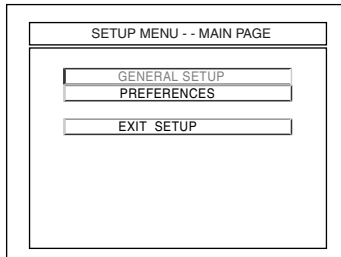

2 Press ▼ (or ▲) to select (highlight) “GENERAL SETUP,” then press ENTER.

The general page appears on the TV screen. The general setup menu is shown on the left column, and the sub menu for the selected (highlighted) item is shown on the right column.

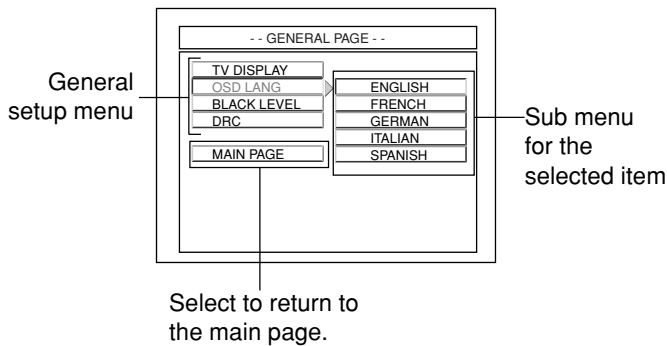
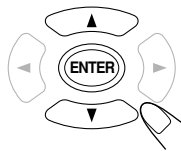

3 Press ▲/▼ to select (highlight) the menu item you want to adjust.

Select “TV DISPLAY” here. The sub menu for “TV DISPLAY” appears on the right column.

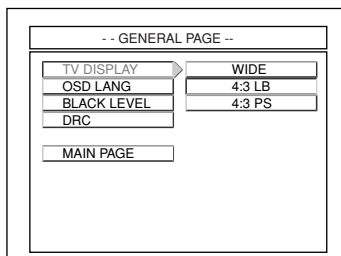
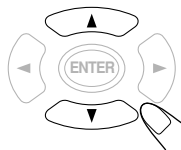

4 Press ►.

The current setting on the sub menu is highlighted.



5 Press ▲/▼ to select the desired setting.

6 Press ENTER.

The selected setting is highlighted.



7 Press ◀ and repeat steps 3 to 6 to set up other items.

To return to the main page

Press ►/◀/▲/▼ to select “MAIN PAGE,” then press ENTER.

To erase the setup menu

Press CHOICE/TIME.

■ To adjust the DRC (Dynamic Range Compression)

1 Repeat steps 1 to 3 of “The basic procedure to set up the system preferences” to select (highlight) “DRC.”

The DRC adjustment tab appears on the right column.

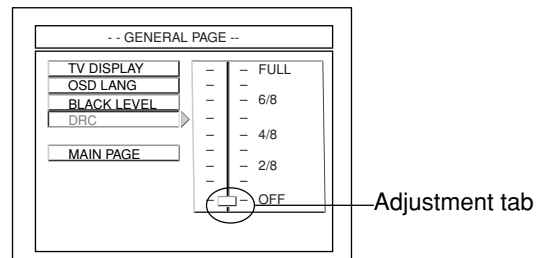

2 Press ►.

“DRC” gets dark and the adjustment tab becomes adjustable.

3 Press ▲/▼ to move the tab to the desired setting.

▲: Increase the effect.
▼: Decrease the effect.

To return to the main page

Press ►/◀/▲/▼ to select “MAIN PAGE,” then press ENTER.

To erase the setup menu

Press CHOICE/TIME.

Setting Up the DVD Preferences

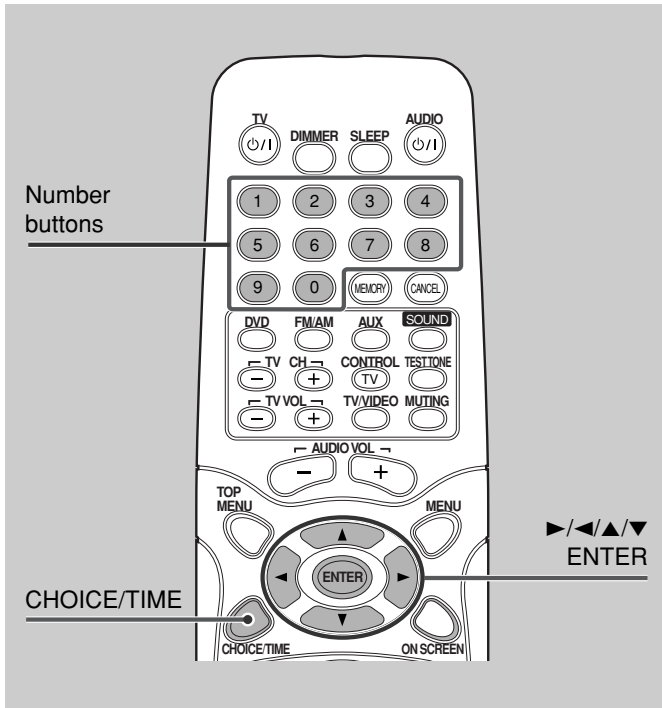

Setting the Preferences

You can select your favorite language to listen to or read on the TV screen. You can also restrict playback of DVDs containing violent scenes or those not suitable for your family members.

On the preferences menu, you can set the following:

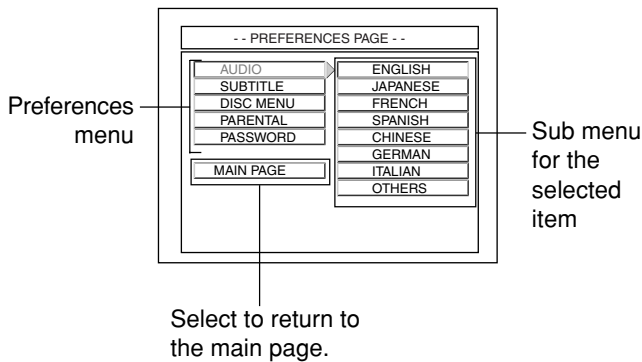

AUDIO:	Select the language you listen to while watching a DVD.
SUBTITLE:	Select the subtitle language you read while watching a DVD.
DISC MENU:	Select the menu language recorded on a DVD which you use while operating the DVD's own menu.
PARENTAL:	Select the restriction level of DVD playback (parental level). <ul style="list-style-type: none"> This setting takes effect only for the DVDs containing the rating level information—Level 1 (most restrictive) to Level 8 (least restrictive).
PASSWORD:	Change the password of PARENTAL.

Languages you can select on this menu

You can select the following languages separately for “AUDIO,” “SUBTITLE,” and “DISC MENU.”

English, Japanese, French, Spanish, Chinese, German, and Italian*.

* You can set languages other than those above as the audio language or the subtitle language by selecting “Others.” See “The basic procedure to set up preferences” below for the detail.

Notes:

The original language will be selected as the initial language regardless of your setting in the following cases:

- If the language you have selected is not recorded on the disc.
- If the disc is programmed to be played back in the original language.

The basic procedure to set up preferences

Ex.: To select the desired language as the initial language for “AUDIO.”

1 Press CHOICE/TIME.

The main page of the setup menu appears on the TV screen.

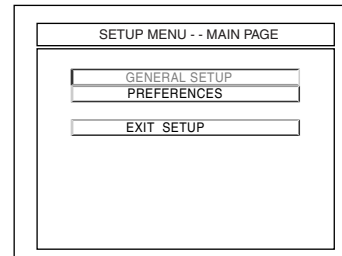

2 Press ▼ (or ▲) to select (highlight) “PREFERENCES,” then press ENTER.

The preferences page appears on the TV screen. The main menu of the preferences is on the left column, and the sub menu for the selected (highlighted) item is shown on the right column.

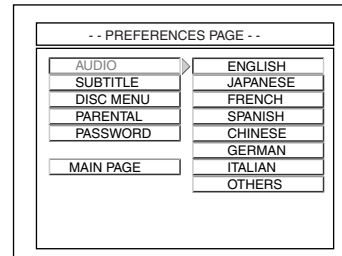
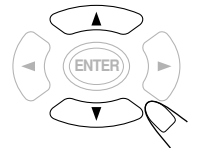

3 Press ▲/▼ to select (highlight) the menu item you want to adjust.

Select “AUDIO” in this case. The sub menu for “AUDIO” appears on the right column.

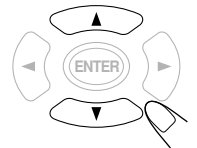

4 Press ►.

The current setting on the sub menu is highlighted.



5 Press ▲/▼ to select the desired setting.

Select the audio language in this case.

6 Press ENTER.

The selected language is highlighted.

- When you select “OTHERS,” the “INPUT LANGUAGE CODE” page appears. Press the number buttons to enter the code (4 digits) of the language you want to set, then press ENTER. The language code list is on page 40.



7 Press ◀ and repeat steps 3 to 6 to set up other items.

To return to the main page

Press ▶/◀/▲/▼ to select “MAIN PAGE,” then press ENTER.

To erase the setup menu

Press CHOICE/TIME.

■ To set the parental (rating) level

Using this function, you can restrict playback of DVD containing violent scenes and those not suitable for your family members. Nobody can play such a disc unless this function is canceled.

- This setting takes effect only for the DVDs containing the rating level information—Level 1 (most restrictive) to Level 8 (least restrictive).

1 Repeat steps 1 to 5 of “The basic procedure to set up preferences” (select “PARENTAL” in step 3) to select the desired parental level, then press ENTER.

The “PASSWORD VERIFY PAGE” appears.

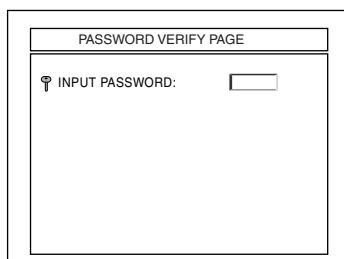

2 Press the number button to enter the password (4 digits), then press ENTER.

The preferences page appears again and the selected parental level is highlighted.

- When shipped from the factory, the password is “7890.”

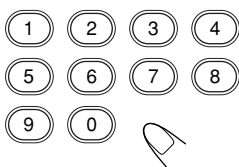

To clear the password entry, press ENTER.

You can enter the password again from the first digit.

- A wrong password is automatically cleared after entering the last digit.

To erase the setup menu

Press CHOICE/TIME.

■ To change the password

1 Repeat steps 1 to 5 of “The basic procedure to set up preferences” (select “PASSWORD” in step 3) to select “CHANGE” then press ENTER.

The “PASSWORD CHANGE PAGE” appears.

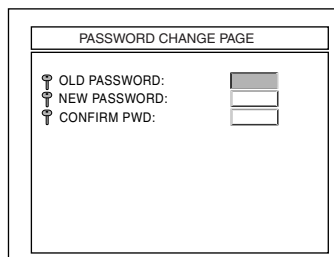

2 Press the number button to enter the current password (4 digits) in the “OLD PASSWORD” box.

Four asterisks appear in the box after entering the right password.

- When shipped from the factory, the password is “7890.”

To clear the password entry, press ENTER.

You can enter the password again from the first digit.

- A wrong password is automatically cleared after entering the last digit.

3 Press the number button to enter a new password (4 digits) in the “NEW PASSWORD” box.

Four asterisks appear in the box after entering the new password.

4 Press the number button to enter the new password (4 digits) again in the “CONFIRM PWD” box to verify the password.

Four asterisks appear in the box after entering the right new password.

- The entered passwords in the “NEW PASSWORD” box and “CONFIRM PWD” box are cleared when you enter a wrong password. Start from step 3 again in that case.
- You cannot cancel the password change after step 4. Repeat steps 1 to 4 to change the password again to restore the old password.

To erase the setup menu

Press CHOICE/TIME.

Setting Up the DVD Preferences

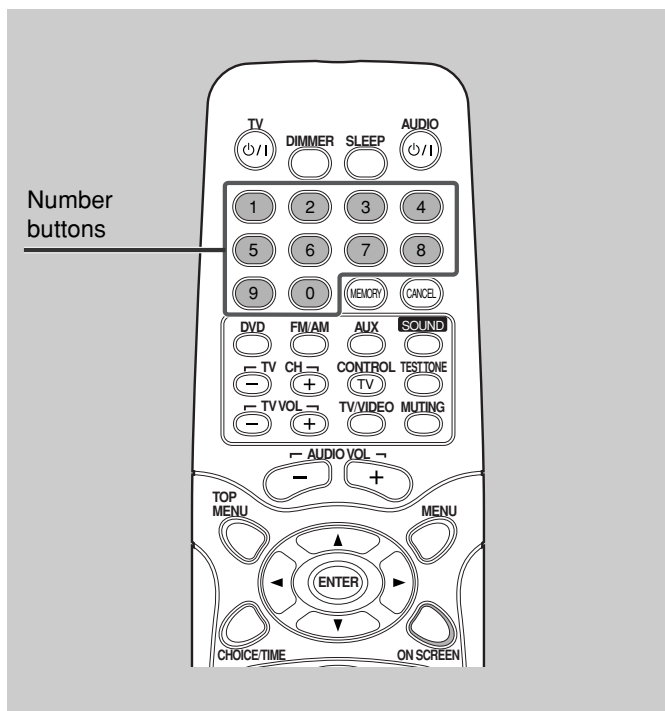

■ To release the parental lock temporarily

When you set a strict parental level, some discs may not be played back at all.

If you try to play back such a disc, you need to input the password to release parental lock temporarily (“INPUT PASSWD:” appears on the TV.) You cannot play the disc before you enter the correct password.

When you enter a wrong password, “PASSWD WRONG” appears on the TV and playback is refused.

■ Language Code List

Code	Language	Code	Language	Code	Language	Code	Language
6565	Afar	7079	Faroese	7678	Lingala	8375	Slovak
6566	Abkhazian	7082	French	7679	Laothian	8376	Slovenian
6570	Afrikaans	7089	Frisian	7684	Lithuanian	8377	Samoaan
6577	Ameharic	7165	Irish	7686	Latvian, Lettish	8378	Shona
6582	Arabic	7168	Scots Gaelic	7771	Malagasy	8379	Somali
6583	Assamese	7176	Galician	7773	Maori	8381	Albanian
6588	Aymara	7178	Guarani	7775	Macedonian	8382	Serbian
6590	Azerbaijani	7185	Gujarati	7776	Malayalam	8385	Sudanese
6665	Bashkir	7265	Hausa	7778	Mongolian	8386	Swedish
6669	Byelorussian	7273	Hindi	7779	Moldavian	8387	Swahili
6671	Bulgarian	7282	Croatian	7782	Marathi	8465	Tamil
6672	Bihari	7285	Hungarian	7783	Malay	8469	Telugu
6678	Bengali; Bangla	7289	Armenian	7784	Maltese	8471	Tajik
6679	Tibetan	7365	Interlingua	7789	Burmese	8472	Thai
6682	Breton	7378	Indonesian	7865	Nauru	8473	Tigrinya
6765	Catalan	7383	Icelandic	7869	Nepali	8475	Turkmen
6779	Corsican	7384	Italian	7876	Dutch	8476	Tagalog
6783	Czech	7387	Hebrew	7879	Norwegian	8479	Tonga
6789	Welsh	7465	Japanese	7982	Oriya	8482	Turkish
6865	Danish	7473	Yiddish	8065	Panjabi	8484	Tatar
6869	German	7487	Javanese	8076	Polish	8487	Twì
6890	Bhutani	7565	Georgian	8083	Pashto, Pushto	8575	Ukrainian
6976	Greek	7575	Kazakh	8084	Portuguese	8582	Urdu
6978	English	7576	Greenlandic	8185	Quechua	8590	Uzbek
6979	Esperanto	7577	Cambodian	8277	Rhaeto-Romance	8673	Vietnamese
6983	Spanish	7578	Kannada	8279	Rumanian	8679	Volapük
6984	Estonian	7579	Korean	8285	Russian	8779	Wolof
6985	Basque	7583	Kashmiri	8365	Sanskrit	8872	Xhosa
7065	Persian	7585	Kurdish	8368	Sindhi	8979	Yoruba
7073	Finnish	7589	Kirghiz	8372	Serbo-Croatian	9072	Chinese
7074	Fiji	7665	Latin	8373	Singhalese	9085	Zulu

Maintenance

To get the best performance of the unit, keep your discs and mechanism clean.

General Notes

In general, you will have the best performance by keeping your discs, and the mechanism clean.

- Store discs in their cases, and keep them in cabinets or on shelves.
- Keep the disc tray closed when not in use.

Handling Discs



- Remove the disc from its case by holding it at the edge while pressing the center hole lightly.
- Do not touch the shiny surface of the disc, or bend the disc.
- Put the disc back in its case after use to prevent warping.

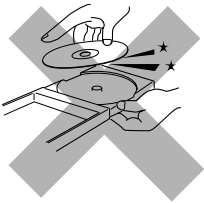

- Be careful not to scratch the surface of the disc when placing it back in its case.
- Avoid exposure to direct sunlight, temperature extremes, and moisture.



To clean the disc

Wipe the disc with a soft cloth in a straight line from center to edge.

DO NOT use any solvent—such as conventional record cleaner, spray, thinner, or benzine—to clean the disc.

Cleaning the unit

• Stains on the unit

Should be wiped off with a soft cloth. If the system is heavily stained, wipe it with a cloth soaked in water-diluted neutral detergent and wrung well, then wipe clean with a dry cloth.

• Since the system may deteriorate in quality, become damaged or get its paint peeled off, be careful about the following.

- DO NOT wipe it with a hard cloth.
- DO NOT wipe it strong.
- DO NOT wipe it with thinner or benzine.
- DO NOT apply any volatile substance such as insecticides to it.
- DO NOT allow any rubber or plastic to remain in contact with it for a long time.

Troubleshooting

Use this chart to help you solve daily operational problems. If there is any problem you cannot solve, contact your JVC service center.

PROBLEM	POSSIBLE CAUSE	SOLUTION
Power does not come on.	The power cord is not plugged in.	Insert the plug into the socket.
The remote control does not work.	<ul style="list-style-type: none"> • It is too far from the center unit, or is not facing the center unit. • There is something obstructing the remote sensor. • The CONTROL TV button has been pressed. • The battery is flat. • The battery has been inserted the wrong way round (+/-). • Sunlight is falling directly on the remote sensor. 	<ul style="list-style-type: none"> • Come close to the center unit. • Avoid any obstacles. • Press DVD, FM/AM, or AUX to operate the system. (See page 11.) • Replace the battery. • Insert the battery correctly. • Shade the remote sensor from direct sunlight.
No sound.	<ul style="list-style-type: none"> • There is a short in the speaker cord. • The audio cord is not connected properly. • An incorrect source has been selected. • Muting is on. 	<ul style="list-style-type: none"> • Reconnect the speaker cord. • Connect the cord properly. (See page 9.) • Select the correct source. (See pages 12 to 16.) • Press MUTING to cancel muting.
Sound is emitted from only one speaker.	<ul style="list-style-type: none"> • The speaker cord is not connected correctly. • Left-right balance is incorrect. 	<ul style="list-style-type: none"> • Connect the cord properly. (See page 7.) • Adjust balance. (See page 17.)
No video.	<ul style="list-style-type: none"> • The video cord is not connected properly. • TV input selection is incorrect. 	<ul style="list-style-type: none"> • Connect the cord properly. (See page 8.) • Select the correct input.
A disc cannot be played.	<ul style="list-style-type: none"> • The system and disc region code numbers are incompatible. • The disc causes the parental (rating) error. 	<ul style="list-style-type: none"> • Replace the disc. (See page 21.) • Enter password to change the parental (rating) level. (See page 39.)
“WRONG DISC” appears on the display.	<ul style="list-style-type: none"> • An incompatible disc is loaded. (See page 21.) 	<ul style="list-style-type: none"> • Replace the disc.
“NO DISC” appears on the display though a disc is inserted.	<ul style="list-style-type: none"> • The disc is dirty. • The disc is scratched. 	<ul style="list-style-type: none"> • Clean the disc. • Replace the disc.
Video and audio are distorted.	<ul style="list-style-type: none"> • The disc is dirty. • A VCR is connected between the center unit and the TV. 	<ul style="list-style-type: none"> • Clean the disc. • Connect the center unit and TV directly.
The edge is missing on the video image.	<ul style="list-style-type: none"> • Initial setup (TV screen size) is incorrect. 	<ul style="list-style-type: none"> • Set TV screen size correctly. (See page 36.)
No picture is displayed on the TV screen, the picture is blurred, or the picture is divided into two parts.	<ul style="list-style-type: none"> • The scanning mode is set to “PROGRESSIVE TV” though the system is connected to the TV which does not support the progressive video input. 	<ul style="list-style-type: none"> • Change the scanning mode to “INTERLACE TV.” (See page 10.)
Continuous static during FM broadcasts.	<ul style="list-style-type: none"> • The received signal is too weak. • The station is too far away. • The antenna is not connected correctly. 	<ul style="list-style-type: none"> • Connect an external FM antenna (see page 5), or contact your dealer. • Select another station. • Check the connection. (See page 5.)
The system does not work correctly.	<ul style="list-style-type: none"> • Lightning or electronic noise interferes with operation of the microcomputer. • Abrupt change of the temperature inside the unit from cold to hot causes condensation of the unit inside. 	<ul style="list-style-type: none"> • Switch power off, and remove and re-insert the power plug in the socket. • Switch power off and leave the unit a few hours before switching power on again.

Specifications

Center unit (XV-THA25)

Amplifier section

Front/Center/Rear:

30 W per channel, min. RMS, driven into 6 Ω at 1 kHz, with no more than 10% total harmonic distortion

Subwoofer:

55 W, min. RMS, driven into 3 Ω at 100 Hz, with no more than 10% total harmonic distortion

Audio section

Audio input sensitivity/Impedance (at 1 kHz)

Analog input:

AUX ("AUDIO IN"): 500 mV/47 k Ω

Signal-to-Noise Ratio: 68 dB

Digital input*:

DIGITAL IN (OPTICAL): -24 dBm to -14.5 dBm
(700 nm \pm 50 nm)

* Corresponding to Linear PCM, Dolby Digital, and DTS Digital Surround (with sampling frequency—32 kHz, 44.1 kHz, 48 kHz)

Video section

Color System: NTSC

Horizontal Resolution: 480 lines

Output Level

VIDEO OUT (Composite): 1.0 V(p-p)/75 Ω

S-VIDEO (Y): 1.0 V(p-p)/75 Ω

(C): 0.286 V(p-p)/75 Ω

COMPONENT VIDEO OUT

Y: 1.0 V(p-p)/75 Ω

P_B/P_R: 0.7 V(p-p)/75 Ω

Tuner section

Tuning Range FM: 87.50 MHz – 108.00 MHz

AM: 530 kHz – 1 710 kHz

Usable Sensitivity FM: 8.0 dBf (0.9 μ V/75 Ω)

AM loop antenna: 650 μ V/m

General

Readable Discs: DVD VIDEO, Video CD, Super Video CD, Audio CD, CD-R/RW (Audio CD, Video CD, Super Video CD, MP3, JPEG), DVD-R/RW (Video format)

Power Requirements: AC 120 V \sim , 60 Hz

Power Consumption: 110 W (at operation)
2 W (in standby mode)

Dimensions (W \times H \times D): 360 mm \times 65 mm \times 404 mm
(14 ³/₁₆ in. \times 2 ⁹/₁₆ in. \times 15 ¹⁵/₁₆ in.)

Mass: 6.3 kg (13.9 lbs)

Subwoofer (SP-WA25)

Speaker: 15 cm (5 ¹⁵/₁₆ in.)
Bass-reflex, magnetically shielded

Power Handling Capacity: 55 W

Impedance: 3 Ω (min)

Frequency Range: 30 Hz to 200 Hz

Dimensions (W \times H \times D): 210 mm \times 382 mm \times 338 mm
(8 ⁵/₁₆ in. \times 15 ¹/₁₆ in. \times 13 ⁵/₁₆ in.)

Mass: 6 kg (13.3 lbs)

Satellite Speakers (SP-XTHA25)

Speakers: 8 cm (3 ³/₁₆ in.)
Bass-reflex, magnetically shielded

Power Handling Capacity: 30 W

Impedance: 6 Ω (min)

Frequency Range: 80 Hz to 20 kHz

Dimensions (W \times H \times D): 105 mm \times 114 mm \times 116 mm
(4 ³/₁₆ in. \times 4 ¹/₂ in. \times 4 ⁵/₈ in.)

Mass: 640 g (1.5 lbs)

Designs & specifications are subject to change without notice.

Authorized Service Centers

QUALITY **JVC**[®] SERVICE

HOW TO LOCATE YOUR JVC SERVICE CENTER

TOLL FREE: 1 (800) 537-5722

<http://www.jvc.com>

Dear Customer,

In order to receive the most satisfaction from your purchase, please read the instruction booklet before operating the unit. In the event that repairs are necessary, please call 1 (800)537-5722 for your nearest authorized servicer or visit our website at **www.JVC.com**

Remember to retain your Bill of Sale for Warranty Service.

Do not service the television yourself

Caution

To prevent electrical shock, do not open the cabinet. There are no user serviceable parts inside. Please refer to qualified service personnel for repairs.

Accessories

To purchase accessories for your JVC product, please call toll free: 1 (800)882-2345 or on the web at **www.JVC.com**

