

JVC

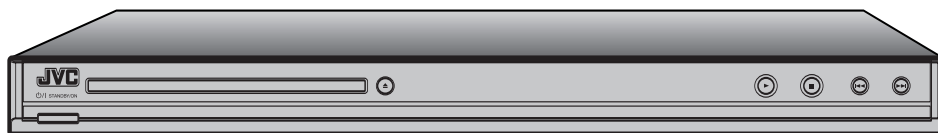

DVD PLAYER

XV-N670B XV-N672S

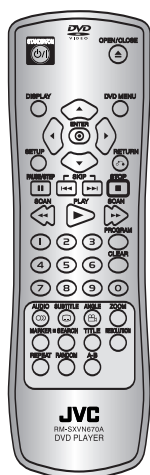

INSTRUCTIONS

For Customer Use :

Enter below the Model No. and Serial No. which are located on the rear of cabinet. Retain this information for future reference.

Model No. _____

Serial No. _____

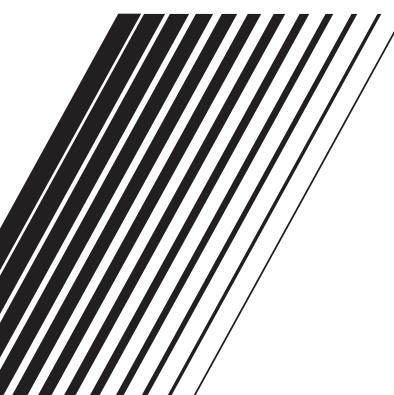



CAUTION: TO REDUCE THE RISK OF ELECTRIC SHOCK DO NOT REMOVE COVER (OR BACK) NO USER-SERVICEABLE PARTS INSIDE REFER SERVICING TO QUALIFIED SERVICE PERSONNEL.



This lightning flash with arrowhead symbol within an equilateral triangle is intended to alert the user to the presence of uninsulated dangerous voltage within the product's enclosure that may be of sufficient magnitude to constitute a risk of electric shock to persons.



The exclamation point within an equilateral triangle is intended to alert the user to the presence of important operating and maintenance (servicing) instructions in the literature accompanying the product.

WARNING: TO REDUCE THE RISK OF FIRE OR ELECTRIC SHOCK, DO NOT EXPOSE THIS APPARATUS TO RAIN OR MOISTURE AND OBJECTS FILLED WITH LIQUIDS, SUCH AS VASES, SHOULD NOT BE PLACED ON THIS APPARATUS.

WARNING: Do not install this equipment in a confined space such as a bookcase or similar unit.

CAUTION: Do not block any ventilation openings. Install in accordance with the manufacturer's instructions.

Slots and openings in the cabinet are provided for ventilation and to ensure reliable operation of the product and to protect it from over heating.

The openings should never be blocked by placing the product on a bed, sofa, rug or other similar surface. This product should not be placed in a built-in installation such as a bookcase or rack unless proper ventilation is provided or the manufacturer's instruction have been adhered to.

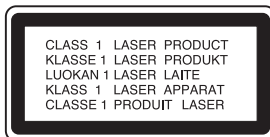

CAUTION:

This product employs a Laser System.

To ensure proper use of this product, please read this owner's manual carefully and retain it for future reference. Should the unit require maintenance, contact an authorized service center.

Use of controls, adjustments or the performance of procedures other than those specified herein may result in hazardous radiation exposure.

To prevent direct exposure to laser beam, do not try to open the enclosure. Visible laser radiation when open. **DO NOT STARE INTO BEAM.**

CAUTION: The apparatus should not be exposed to water (dripping or splashing) and no objects filled with liquids, such as vases, should be placed on the apparatus.

FCC WARNING: This equipment may generate or use radio frequency energy. Changes or modifications to this equipment may cause harmful interference unless the modifications are expressly approved in the instruction manual. The user could lose the authority to operate this equipment if an unauthorized change or modification is made.

REGULATORY INFORMATION: FCC Part 15

This equipment has been tested and found to comply with the limits for a Class B digital device, pursuant to Part 15 of the FCC Rules.

These limits are designed to provide reasonable protection against harmful interference in a residential installation. This equipment generates, uses and can radiate radio frequency energy and, if not installed and used in accordance with the instructions, may cause harmful interference to radio communications.

However, there is no guarantee that interference will not occur in a particular installation. If this equipment does cause harmful interference to radio or television reception, which can be determined by turning the equipment off and on, the user is encouraged to try to correct the interference by one or more of the following measures:

- Reorient or relocate the receiving antenna.
- Increase the separation between the equipment and receiver.
- Connect the equipment into an outlet on a circuit different from that to which the receiver is connected.
- Consult the dealer or an experienced radio/TV technician for help.

CAUTION concerning the Power Cord

Most devices are recommended be placed on a dedicated circuit;

That is, a single outlet circuit which powers only that electronic device and has no additional outlets or branch circuits. Check the specification page of this owner's manual to be certain.

Do not overload wall outlets. Overloaded wall outlets, loose or damaged wall outlets, extension cords, frayed power cords, or damaged or cracked wire insulation are dangerous. Any of these conditions could result in electric shock or fire. Periodically examine the cord of your appliance, and if its appearance indicates damage or deterioration, unplug it, discontinue use of the appliance, and have the cord replaced with an exact replacement part by an authorized servicer.

Protect the power cord from physical or mechanical abuse, such as being twisted, kinked, pinched, closed in a door, or walked upon. Pay particular attention to plugs, wall outlets, and the point where the cord exits the appliance.

To disconnect power from the mains, pull out the mains cord plug. When installing the product, ensure that the plug is easily accessible.

IMPORTANT SAFETY INSTRUCTIONS

CAUTION: PLEASE READ AND OBSERVE ALL WARNINGS AND INSTRUCTIONS IN THIS OWNER'S MANUAL. AND THOSE MARKED ON THE PRODUCT. RETAIN THIS BOOKLET FOR FUTURE REFERENCE.

This product has been designed and manufactured to assure personal safety. Improper use can result in electric shock or fire hazard. The safeguards incorporated in this product will protect you if you observe the following procedures for installation, use, and servicing.

This product does not contain any parts that can be repaired by the user.

DO NOT REMOVE THE CABINET COVER, OR YOU MAY BE EXPOSED TO DANGEROUS VOLTAGE. REFER SERVICING TO QUALIFIED SERVICE PERSONNEL ONLY.

- 1. Read these instructions.** - All these safety and operating instructions should be read before the product is operated.
- 2. Keep these instructions.** - The safety, operating and use instructions should be retained for future reference.
- 3. Heed all warnings.** - All warnings on the product and in the operating instructions should be adhered to.
- 4. Follow all instructions.** - All operating and use instructions should be followed.
- 5. Do not use this apparatus near water.** - For example: near a bath tub, wash bowl, kitchen sink, laundry tub, in a wet basement; or near a swimming pool; and other areas located near water.
- 6. Clean only with dry cloth.** - Unplug this product from the wall outlet before cleaning. Do not use liquid cleaners.
- 7. Do not block any ventilation openings. Install in accordance with the manufacturer's instructions.** - Slots and openings in the cabinet are provided for ventilation and to ensure reliable operation of the product and to protect it from over- heating. The openings should never be blocked by placing the product on a bed, sofa, rug or other similar surface. This product should not be placed in a built-in installation such as a bookcase or rack unless proper ventilation is provided or the manufacturer's instructions have been adhered to.
- 8. Do not install near any heat sources such as radiators, heat registers, stoves, or other apparatus (including amplifiers) that produce heat.**
- 9. Do not defeat the safety purpose of the polarized or grounding-type plug.** A polarized plug has two blades with one wider than the other. A grounding type plug has two blades and a third grounding prong. The wide blade or the third prong are provided for your safety. If the provided plug does not fit into your outlet, consult an electrician for replacement of the obsolete outlet.
- 10. Protect the power cord from being walked on or pinched particularly at plugs, convenience receptacles, and the point where they exit from the apparatus.**
- 11. Only use attachments/accessories specified by the manufacturer.**
- 12. Use only with the cart, stand, tripod, bracket, or table specified by the manufacturer, or sold with apparatus. When a cart is used, use caution when moving the cart/product combination to avoid injury from tip-over.**



- 13. Unplug this apparatus during lightning storms or when unused for long periods of time.**
- 14. Refer all servicing to qualified service personnel. Servicing is required when the product has been damaged in any way, such as power-supply cord or plug is damaged, liquid has been spilled or objects have fallen into the apparatus, the product has been exposed to rain or moisture, does not operate normally, or has been dropped.**

Contents

Introduction	5-8	Operations	16-22
About the  Symbol Display	5	General Features	16
Symbol Used in this Manual	5	Additional Features	17
Notes on Discs	5	Playing an Audio CD or MP3/WMA file	18
Handling Discs	5	Programmed Playback	19
Storing Discs	5	Repeat Programmed Tracks	19
Cleaning Discs	5	Erasing a Track from Program List	19
Types of Playable Discs	6	Erasing the Complete Program List	19
Regional Code	6	Viewing a JPEG file	20
Front Panel	7	Slide Show	20
Remote Control	8	Still Picture	20
Remote Control operation	8	Moving to another file	20
Remote Control Battery installation	8	Zoom	20
		Rotating the picture	20
		Listening to MP3/WMA music while watching picture	20
		Playing a DivX Movie file	21
		Playing a DVD VR format Disc	22
Installation and Setup	9-15		
Setting up the Player	9		
DVD Player Connections	9-10		
Video and Audio Connections to Your TV ...	9		
Resolution setting	9		
HDMI connection	10		
Audio Connection to Optional Equipment ..	11		
When you turn on for the first time	11		
Displaying Disc Information on-screen	12		
Initial Settings	12-15		
General Operation	12		
LANGUAGE	13		
• Menu Language	13		
• Disc Audio / Subtitle / Menu	13		
DISPLAY	13		
• TV Aspect	13		
• Display Mode	13		
AUDIO	14		
• Dolby Digital / DTS / MPEG	14		
• Sample Freq. (Frequency)	14		
• DRC (Dynamic Range Control)	14		
• Vocal	14		
OTHERS	15		
• PBC	15		
• B.L.E. (Black Level Expansion)	15		
• DivX(R) VOD	15		
		Reference	23-27
		Remote Control Function	23
		Maintenance and Service	23
		Language Codes	24
		Troubleshooting	25
		Specifications	26
		Warranty (Only in U.S.A.)	27

Introduction

To ensure proper use of this product, please read this owner's manual carefully and retain it for future reference.

This manual provides information on the operation and maintenance of your DVD player. Should the unit require service, contact an authorized service location.

About the Symbol Display

"  " may appear on your TV display during operation and indicates that the function explained in this owner's manual is not available on that specific DVD video disc.

Symbol Used in this Manual







Note:

Indicates special notes and operating features.

Tip:

Indicates tips and hints for making the task easier.

A section whose title has one of the following symbols is applicable only to the disc represented by the symbol.

-  All discs and file listed below
-  DVD and finalized DVD±R/RW
-  Video CDs
-  Audio CDs
-  MP3 files
-  WMA files
-  DivX files

Notes on Discs

Handling Discs

Do not touch the playback side of the disc. Hold the disc by the edges so that fingerprints do not get on the surface. Never stick paper or tape on the disc.

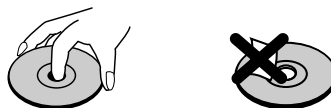

Storing Discs

After playing, store the disc in its case. Do not expose the disc to direct sunlight or sources of heat and never leave it in a parked car exposed to direct sunlight.

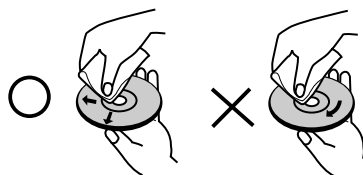

Cleaning Discs

Fingerprints and dust on the disc can cause poor picture quality and sound distortion. Before playing, clean the disc with a clean cloth. Wipe the disc from the center out.



Do not use strong solvents such as alcohol, benzene, thinner, commercially available cleaners, or anti-static spray intended for older vinyl records.

Types of Playable Discs

	DVD (8 cm / 12 cm disc)
	Video CD (VCD/SVCD) (8 cm / 12 cm disc)
	Audio CD (8 cm / 12 cm disc)

In addition, this unit plays DVD±R/RW and CD-R/RW, Dual disc that contains audio titles, DivX, MP3, WMA, and/or JPEG files.



This indicates a product feature that is capable of playing DVD-RW discs recorded with Video Recording format.

Notes:

- Depending on the conditions of the recording equipment or the CD-R/RW (or DVD±R/RW) disc itself, some CD-R/RW (or DVD±R/RW) discs may not be played on the unit.
- Do not use irregularly shaped CDs (e.g., heart-shaped or octagonal) since they may result in malfunctions.
- This DVD player requires discs and recordings to meet certain technical standards in order to achieve optimal playback quality. Pre-recorded DVDs are automatically set to these standards. There are many different types of recordable disc formats (including CD-R containing MP3 or WMA files) and these require certain pre-existing conditions (see above) to ensure compatible playback.

Customers should note that permission is required in order to download MP3 / WMA files and music from the Internet. Our company has no right to grant such permission. Permission should always be sought from the copyright owner.

Regional Code

This unit has a regional code printed on the rear of the unit. This unit can play only DVD discs labeled as the same as the rear of the unit or "ALL".

Notes on Regional Codes

- Most DVD discs have a globe with one or more numbers in it clearly visible on the cover. This number must match your unit's regional code or the disc cannot play.
- If you try to play a DVD with a different regional code from your player, the message "Check Regional Code" appears on the TV screen.

Notes on Copyrights:

It is forbidden by law to copy, broadcast, show, broadcast via cable, play in public, or rent copyrighted material without permission. This product features the copy protection function developed by Macrovision. Copy protection signals are recorded on some discs. When recording and playing the pictures of these discs picture noise will appear. This product incorporates copyright protection technology that is protected by method claims of certain U.S. patents and other intellectual property rights owned by Macrovision Corporation and other rights owners. The Use of this copyright protection technology must be authorized by Macrovision Corporation, and is intended for home and other limited viewing uses only unless otherwise authorized by Macrovision Corporation. Reverse engineering or disassembly is prohibited.

CONSUMERS SHOULD NOTE THAT NOT ALL HIGH DEFINITION TELEVISION SETS ARE FULLY COMPATIBLE WITH THIS PRODUCT AND MAY CAUSE ARTIFACTS TO BE DISPLAYED IN THE PICTURE. IN CASE OF 525 PROGRESSIVE SCAN PICTURE PROBLEMS, IT IS RECOMMENDED THAT THE USER SWITCH THE CONNECTION TO THE 'STANDARD DEFINITION' OUTPUT. IF THERE ARE QUESTIONS REGARDING OUR TV SET COMPATIBILITY WITH THIS MODEL 525p DVD PLAYER, PLEASE CONTACT OUR CUSTOMER SERVICE CENTER.

Front Panel

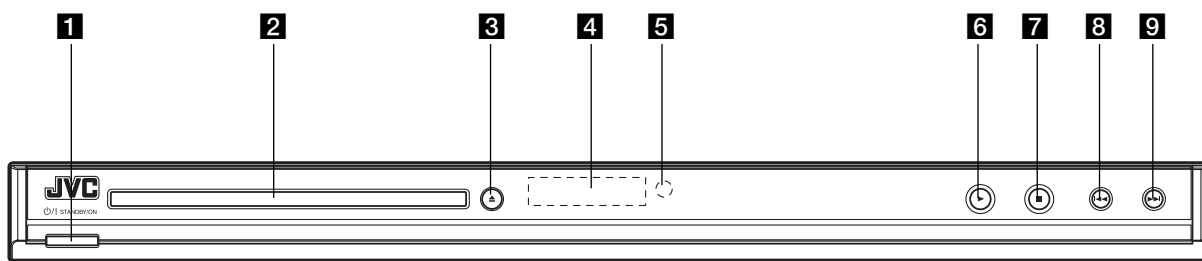

- | | |
|---|---|
| <p>1 STANDBY/ON
Switches the unit ON and OFF.</p> <p>2 Disc Tray
Insert a disc here.</p> <p>3 (OPEN/CLOSE)
Opens or closes the disc tray.</p> <p>4 Display window
Shows the current status of the unit.</p> <p>5 Remote Sensor
Point the remote control here.</p> | <p>6 (PLAY)
Starts playback.</p> <p>7 (STOP)
Stops playback.</p> <p>8 (SKIP)
Returns to the beginning of current chapter or track or go to the previous chapter or track. Press and hold the button for search backward.</p> <p>9 (SKIP)
Go to the next chapter or track. Press and hold the button for search forward.</p> |
|---|---|

Remote Control

STANDBY/ON (⏻/⏻)
Switches DVD Player ON and OFF.

OPEN/CLOSE (⏮)
Opens and closes the disc tray.

PAUSE/STEP (⏸)
Pauses playback temporarily/ press repeatedly for frame-by-frame playback.

SKIP (⏮ / ⏭)
Go to next chapter or track.
Returns to the beginning of current chapter or track or go to the previous chapter or track.

STOP (■)
Stops playback.

SCAN (⏮ / ⏭)
Search backward or forward.

PLAY (▶)
Starts playback.

0-9 numerical buttons
Selects numbered items in a menu.

PROGRAM
Enter to program edit mode.

CLEAR
Removes a track number on the Program List or a mark on the Marker Search menu.

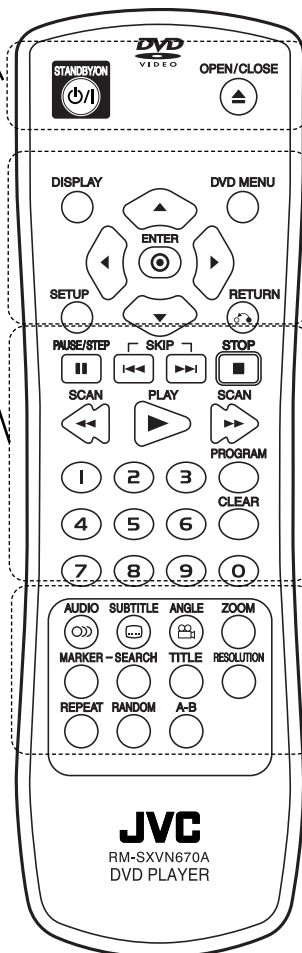

DISPLAY
Accesses On-Screen Display.

DVD MENU
Accesses menu on a DVD disc.

◀ / ▶ / ▲ / ▼ (left/right/up/down)
Selects an item in the menu.

ENTER (⊙)
Confirms menu selection.

SETUP
Accesses or removes Setup menu.

RETURN (↶)
Displays the menu of a video CD with PBC.

AUDIO (🔊)
Selects an audio language or an audio channel.

SUBTITLE (🗨)
Selects a subtitle language.

ANGLE (📷)
Selects a DVD camera angle, if available.

ZOOM
Enlarges video image.

MARKER
Marks any point during playback.

SEARCH
Displays MARKER SEARCH menu.

TITLE
Displays title menu, if available.

RESOLUTION
You can change the resolution depending on your TV.

REPEAT
Repeats chapter, track, title or all.

RANDOM
Plays tracks in random order.

A-B
Repeats sequence from point A to point B.

Remote Control operation

Point the remote control at the remote sensor and press the buttons.

Cautions:

- Do not mix old and new batteries and never mix different types of batteries such as standard, alkaline, etc.
- Do not put the batteries in the place where young children can reach.

Remote Control Battery installation

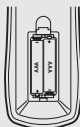

Detach the battery cover on the rear of the remote control, and insert two batteries (size AAA) with ⊕ and ⊖ aligned correctly.

Installation and Setup

Setting up the Player

The picture and sound of a nearby TV, VCR, or radio may be distorted during playback. If this occurs, position the player away from the TV, VCR, or radio, or turn off the unit after removing the disc.

DVD Player Connections

Depending on your TV and other equipment there are various ways you can connect the player. Please refer to the manuals of your TV, stereo system or other devices as necessary for additional connection information.

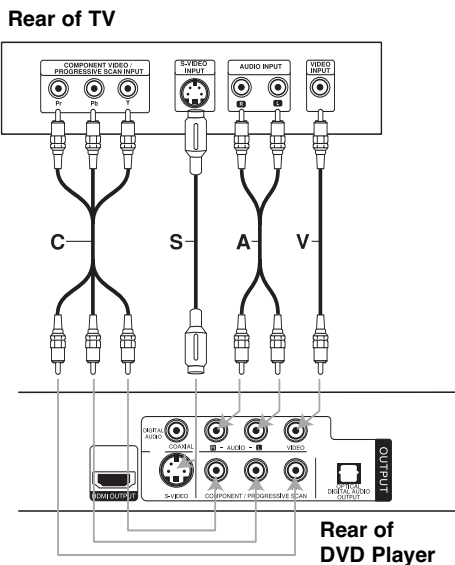

Video and Audio Connections to Your TV

Make sure the DVD player is connected directly to the TV and not to a VCR, otherwise the DVD image could be distorted by the copy protection system.

S-Video – Connect the S-VIDEO OUTPUT jack on the DVD Player to the S-Video in jack on the TV using the S-Video cable (**S**).

Video – Connect the VIDEO OUTPUT jack on the DVD player to the video in jack on the TV using the video cable (**V**).

Audio – Connect the left and right AUDIO OUTPUT jacks of the DVD Player to the audio left and right IN jacks on the TV using the audio cables (**A**).

Do not connect the DVD Player's AUDIO OUTPUT jack to the phone in jack (record deck) of your audio system.

Component Video – Connect the COMPONENT / PROGRESSIVE SCAN OUTPUT jacks on the DVD Player to the corresponding jacks on the TV using an Y PB PR cable (**C**).

Progressive Scan

- If your television is a high-definition or “digital ready” television, you may take advantage of the DVD player's progressive scan output for the highest possible video resolution.
- Progressive scan does not work with the analog video connections (yellow VIDEO OUTPUT jack and S-VIDEO OUTPUT jack).
- The 1080p, 720p and 480p resolutions are the progressive scan applied resolution.

Resolution setting

1. Press RESOLUTION once. The current resolution setting will be appears in the display window.
2. Press RESOLUTION repeatedly to change the resolution you want.

The available resolution according to the connections are as shown below.

OUTPUT CONNECTION	Available Resolution
HDMI VIDEO OUTPUT	1920 x 1080p 1920 x 1080i 1280 x 720p 720 x 480p 720 x 480i
COMPONENT VIDEO OUTPUT	1920 x 1080p 1920 x 1080i 1280 x 720p 720 x 480p 720 x 480i
VIDEO OUTPUT	720 x 480i
S-VIDEO OUTPUT	720 x 480i

Notes:

- VIDEO OUTPUT and S-VIDEO OUTPUT is always at 480i standard resolution.
- If your TV does not accept your resolution setting, abnormal picture appears on the screen. Please read TV's owner's manual then set the resolution that your TV can accept.
- For 720p, 1080i and 1080p resolution on the component video out, only non-copy protected discs can be played back. If the disc is copy protected, it will be displayed at the 480p resolution without HDMI cable connection. With HDMI cable connection, the picture may not be displayed properly.

HDMI connection

If you have an HDMI TV or a monitor, you can connect it to this player using an HDMI cable.

1. Set the TV's source to HDMI (refer to TV Owner's manual).
2. Connect the HDMI OUTPUT jack on the unit to the HDMI jack on a HDMI compatible TV or monitor (**H**).
3. Press RESOLUTION repeatedly to select the desired resolution.

Notes:

- Both PCM and Bitstream Audio out is available when the sample frequency is set to 48kHz in HDMI connection.
- If Audio setup is set to bitstream and your TV does not support Bitstream Audio out in HDMI connection, audio sound may not be outputted or distorted.
- When the no sound or noisy sound are outputted with HDMI connection, set the Audio option [Dolby Digital, DTS or MPEG] in SETUP menu to PCM or Off.
- The arrow on the cable connector body should face up for correct alignment with the connector on the player.

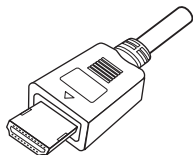

- If there is noise or lines on the screen, please check the HDMI cable.
- Not all HDCP-compatible DVI devices will work with this unit.
- If your HDMI TV does not support HDCP, the blue screen appears on the screen.
- If the abnormal picture appears on the TV screen, turn off the unit and then turn the unit on again.

Tip:

When you use HDMI connection, you can change the resolution (480i, 480p, 720p, 1080i, 1080p) for the HDMI output.

HDMI compatible TV

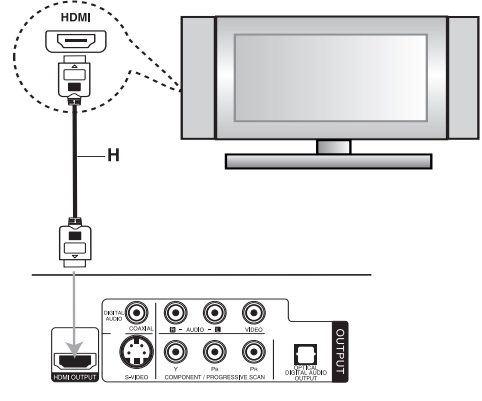

Rear of DVD player

About HDMI

HDMI (High Definition Multimedia Interface) supports both video and audio on a single digital connection for use with DVD Players, Set-Top Boxes, and other AV devices.

HDMI was developed to provide the technologies of HDCP (High-bandwidth Digital Content Protection). HDCP is used to protect digital content transmitted and received.

HDMI has the capability to support standard, enhanced or high-definition video plus standard to multi-channel surround-sound audio, HDMI features include uncompressed digital video, a bandwidth of up to 5 gigabytes per second, one connector (instead of several cables and connectors), and communication between the AV source and AV devices such as DTVs.

HDMI, the HDMI logo and High-Definition Multimedia Interface are trademarks or registered trademarks of HDMI licensing LLC.

Audio Connection to Optional Equipment

Connect the DVD player to your optional equipment for audio output.

Rear of DVD Player

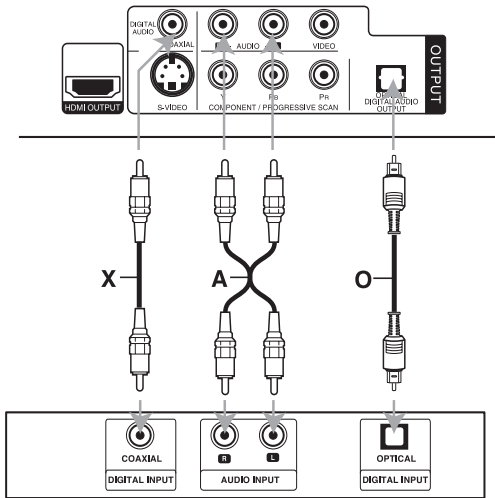

Amplifier (Receiver)

Manufactured under license from Dolby Laboratories. "Dolby", "Pro Logic" and the double-D symbol are trademarks of Dolby Laboratories.

Manufactured under license under U.S. Patent #: 5,451,942 & other U.S. and worldwide patents issued & pending. DTS and DTS Digital Out are registered trademarks and the DTS logos and Symbol are trademarks of DTS, Inc. © 1996-2007 DTS, Inc. All Rights Reserved.

Amplifier equipped with 2-channel analog stereo or Dolby Pro Logic II / Pro Logic: Connect the left and right AUDIO OUTPUT jacks on the DVD player to the audio left and right IN jacks on your amplifier, receiver, or stereo system, using the audio cables (A).

Amplifier equipped with 2-channel digital stereo (PCM) or audio / video receiver equipped with a multi-channel decoder (Dolby Digital™, MPEG 2, or DTS):

Connect one of the DVD Player's DIGITAL AUDIO OUTPUT jacks (OPTICAL O or COAXIAL X) to the corresponding jack on your amplifier. Use an optional digital (OPTICAL O or COAXIAL X) audio cable.

Digital Multi-channel sound

A digital multi-channel connection provides the best sound quality. For this you need a multi-channel audio / video receiver that supports one or more of the audio formats supported by your DVD player such as MPEG 2, Dolby Digital and DTS. Check the receiver manual and the logos on the front of the receiver.

Notes:

- If the audio format of the digital output does not match the capabilities of your receiver, the receiver produces a strong, distorted sound or no sound at all.
- Six Channel Digital Surround Sound via a digital connection can only be obtained if your receiver is equipped with a Digital Multi-channel decoder.

When you turn on for the first time

The menu for a language selection will appear when you turn on the unit for the first time. You must select a language to use the unit. Use ◀ / ▶ / ▲ / ▼ to select a language then press ENTER and the confirm menu will appear. Use ◀ / ▶ to select [Enter] then press ENTER.

Displaying Disc Information on-screen

You can display various information about the disc loaded on-screen.

1. Press DISPLAY to show various playback information.
The displayed items differ depending on the disc type or playing status.

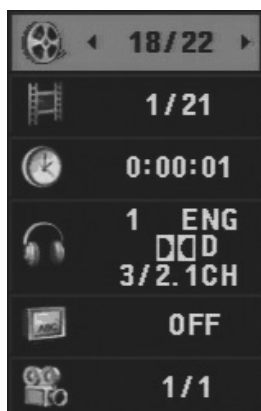

2. You can select an item by pressing ▲ / ▼ and change or select the setting by pressing ◀ / ▶.
 - Title (Track) – Current title (or track) number/total number of titles (or tracks).
 - Chapter – Current chapter number/total number of chapters.
 - Time – Elapsed playing time.
 - Audio – Selected audio language or channel.
 - Subtitle – Selected subtitle.
 - Angle – Selected angle/total number of angles.

Note:

If any button is not pressed for a few seconds, the on-screen display disappears.

Initial Settings

By using the Setup menu, you can make various adjustments to items such as picture and sound. You can also set a language for the subtitles and the Setup menu, among other things. For details on each Setup menu item, see pages 13 to 15.

To display and exit the Menu:

Press SETUP to display the menu. A second press of SETUP will take you back to initial screen.

To go to the next level:

Press ▶ on the remote control.

To go back to the previous level:

Press ◀ on the remote control.

General Operation

1. Press SETUP.
The Setup menu appears.



2. Use ▲ / ▼ to select the desired option then press ▶ to move to the second level. The screen shows the current setting for the selected item, as well as alternate setting(s).
3. Use ▲ / ▼ to select the second desired option and then press ▶ to move to the third level.
4. Use ▲ / ▼ to select the desired setting then press ENTER to confirm your selection. Some items require additional steps.
5. Press SETUP or PLAY (▶) to exit the Setup menu.

LANGUAGE



Menu Language

Select a language for the Setup menu and the on-screen display.

Disc Audio / Subtitle / Menu

Select the language you prefer for the audio track (disc audio), subtitles, and the disc menu.

Original – Refers to the original language in which the disc was recorded.

Other – To select another language, press numeric buttons and then ENTER to enter the corresponding 4-digit number according to the language code list on the page 24. If you enter the wrong language code, press CLEAR.

Off (for Disc Subtitle) – Turn off Subtitle.

DISPLAY



TV Aspect

4:3 – Select when a standard 4:3 TV is connected.

16:9 – Select when a 16:9 wide TV is connected.

Display Mode

The Display Mode setting works only when the TV Aspect mode is set to 4:3.

Letterbox – Displays a wide picture with bands on the upper and lower portions of the screen.

Panscan – Automatically displays the wide picture on the entire screen and cuts off the portions that do not fit.

AUDIO

Each DVD disc has a variety of audio output options. Set the player's AUDIO options according to the type of audio system you use.

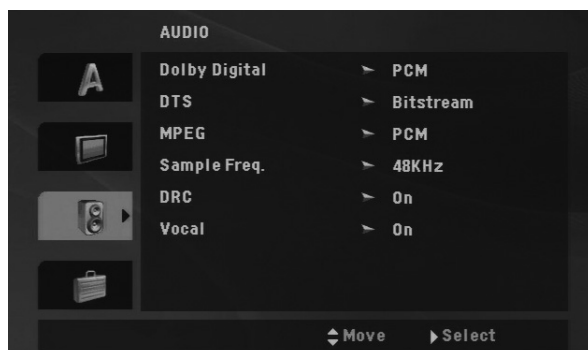

Dolby Digital / DTS / MPEG

Bitstream – Select “Bitstream” if you connect this unit's DIGITAL AUDIO OUTPUT jack to an amplifier or other equipment with a Dolby Digital, DTS or MPEG decoder.

PCM (for Dolby Digital / MPEG) – Select when connected to a two-channel digital stereo amplifier. DVDs encoded in Dolby Digital, MPEG will be automatically downmixed to two-channel PCM audio.

Off (for DTS) – If you select “Off”, the DTS signal is not output through the DIGITAL AUDIO OUTPUT jack.

Sample Freq. (Frequency)

If your receiver or amplifier is NOT capable of handling 96 kHz signals, select 48 kHz. When this choice is made, this unit automatically converts any 96 kHz signals to 48 kHz so your system can decode them.

If your receiver or amplifier is capable of handling 96 kHz signals, select 96 kHz.

Check the documentation for your amplifier to verify its capabilities.

DRC (Dynamic Range Control)

With the DVD format, you can hear a program's soundtrack in the most accurate and realistic presentation. However, you may wish to compress the dynamic range of the audio output (the difference between the loudest sounds and the quietest ones). This allows you to listen to a movie at a lower volume without losing clarity of sound. Set DRC to On for this effect.

Vocal

Set to On only when a multi-channel karaoke DVD is playing. The karaoke channels on the disc mix into normal stereo sound.

OTHERS



PBC

Set Playback Control (PBC) to On or Off.

On: Video CDs with PBC are played according to the PBC.

Off: Video CDs with PBC are played in the same way as Audio CDs.

B.L.E. (Black Level Expansion)

To select the black level of playback pictures. Set your preference and monitor's ability.

On: Expanded grey scale. (0 IRE cut off)

Off: Standard grey scale. (7.5 IRE cut off)

DivX(R) VOD

We provide you the DivX® VOD (Video On Demand) registration code that allows you to rent and purchase videos based on the DivX® VOD service. For more information, visit www.divx.com/vod.

1. Select "DivX(R) VOD" option and then press ►.
2. Press ENTER while "Select" is selected and the registration code will appear.
Use the registration code to purchase or rent the videos from DivX® VOD service at www.divx.com/vod. Follow the instructions and download the video onto a disc for playback on this unit.
3. Press ENTER to exit.

Note:

All the downloaded videos from DivX® VOD can only be played back on this unit.

Operations

General Features

Buttons	Operations	Discs
OPEN/CLOSE (▲)	Opens or closes the disc tray.	ALL
PAUSE/STEP (⏸)	During playback, press PAUSE/STEP (⏸) to pause playback. Press PAUSE/STEP (⏸) repeatedly to play Frame-by-Frame.	ALL DVD VCD DivX
SKIP (⏮ / ⏭)	During playback, press SKIP (⏮ or ⏭) to go to the next chapter/track or to return to the beginning of the current chapter/track. Press SKIP (⏮) twice briefly to step back to the previous chapter/track.	DVD VCD DivX ACD MP3 WMA
SCAN (⏪ / ⏩)	During playback, press SCAN (⏪ or ⏩) repeatedly to select the required scan speed. DVD, DivX disc; 4 steps Video CD, MP3/WMA, Audio CD ; 3 steps While the playback is paused, press SCAN (⏪ or ⏩) repeatedly to play in slow motion. DVD; 4 steps Video CD, DivX disc; 4 steps (Forward only)	DVD VCD DivX ACD MP3 WMA DVD VCD DivX
REPEAT	During playback, press REPEAT repeatedly to select a desired repeat mode. DVD Video discs: Chapter/Title/Off Video CD, Audio CD, DivX/MP3/WMA discs: Track/All/Off	DVD VCD DivX ACD MP3 WMA
A-B	Press the A-B button one at a time to select a point A and point B and repeats a sequence from point A (Starting point) to point B (End point).	DVD VCD ACD DivX
ZOOM	During playback or pause mode, press ZOOM to enlarge the video image (3 steps). You can move through the zoomed picture using ◀ / ▶ / ▲ / ▼ buttons. Press CLEAR to exit.	DVD VCD DivX
RANDOM	During playback or in stop mode, press RANDOM for random playback.	ACD MP3 WMA
TITLE	If the current DVD title has a menu, the title menu appears on the screen. Otherwise, the disc menu may appears.	DVD
DVD MENU	The disc menu appears on the screen.	DVD
ANGLE (📷)	During playback of DVD disc that contains scenes recorded at different camera angles, press ANGLE (📷) repeatedly to select a desired angle.	DVD
SUBTITLE (🗨)	During playback, press SUBTITLE (🗨) repeatedly to select a desired subtitle language.	DVD DivX
AUDIO (🔊)	During playback, press AUDIO (🔊) repeatedly to hear a different audio language, audio channel or encoding method.	DVD DivX VCD

Notes on general features:

- On a Video CD with PBC, you must set PBC to Off on the setup menu to use the repeat function (See “PBC” on page 15).
- If you press SKIP (▶▶) once during Repeat Chapter (Track) playback, the repeat playback cancels.
- Zoom may not work on some DVDs.
- When you are playing a DVD disc that contains scenes recorded at different camera angles, the angle indicator will be displayed on the TV screen during the operations as an indication that angle switching is possible.

Additional Features**Time Search** DVD VCD DivX

To start playing at any chosen time on the disc:

1. Press DISPLAY during playback.
2. Press ▲ / ▼ to select the time clock icon and “--:--:--” appears.
3. Input the required start time in hours, minutes, and seconds from left to right. If you enter the wrong numbers, press CLEAR to remove the numbers you entered. Then input the correct numbers.
4. Press ENTER to confirm.
Playback starts from the selected time.

Marker Search DVD VCD DivX**To enter a Marker**

You can start playback from up to nine memorized points. To enter a marker, press MARKER at the desired point on the disc. The Marker icon appears on the TV screen briefly. Repeat to enter up to nine markers.

To Recall or Clear a Marked Scene

1. During disc playback, press SEARCH. The marker search menu appears on the screen.
2. Within 9 seconds, press ◀ / ▶ to select a marker number that you want to recall or clear.
3. Press ENTER and playback starts from the marked scene. Or, Press CLEAR and the marker number is erased from the list.
4. You can play any marker by inputting its number on the marker search menu.

Last Scene Memory DVD VCD 1.1 ACD

This player memorizes last scene from the last disc that is viewed. The last scene remains in memory even if you remove the disc from the player or switch off the player. If you load a disc that has the scene memorized, the scene is automatically recalled.

Note:

This player does not memorize the scene of a disc if you switch off the player before commencing to play the disc.

Screen Saver / Auto Power Off

The screen saver appears when you leave the DVD player in Stop mode for about five minutes. If the Screen Saver is displayed for five minutes, the DVD Player automatically turns itself off.

Playing an Audio CD or MP3/WMA file

This unit can play Audio CDs or MP3/WMA files.

MP3/ WMA/ Audio CD

Once you insert an MP3/WMA files recorded media or Audio CD, a menu appears on the TV screen. Use ▲ / ▼ to select a track/file and then press PLAY (▶) or ENTER and playback starts. You can use variable playback functions. Refer to page 16-17.



ID3 TAG

When playing a file containing information such as track titles, you can see the information by pressing DISPLAY. [Title, Artist, Album, Year, Comment]

Tips:

- If you are in a file list and want to return to the previous Folder list, use ▲ / ▼ buttons to highlight  and press ENTER.
- Press DVD MENU to move to the next page.
- On a DISC with MP3/WMA, JPEG and MOVIE file, you can switch MUSIC, PHOTO and MOVIE menu. Press TITLE, and MUSIC, PHOTO or MOVIE word on top of the menu is highlighted.

MP3 / WMA disc compatibility with this player is limited as follows:

- Sampling frequency: within 8 - 48 kHz (MP3), within 22 - 48kHz (WMA)
- Bit rate: within 8 - 320kbps (MP3), 32 - 256 kbps (WMA)
- The player cannot read an MP3/WMA file that has a file extension as non than “.mp3” / “.wma”.
- CD-R/RW, DVD±R/RW Format: ISO 9660
- File names should have a maximum of 8 letters and must incorporate an .mp3 or .wma extension.
- They should not contain special letters such as / ? * : “ < > | etc.
- The total number of files in a folder should be less than 650 files.







Programmed Playback

The program function enables you to store your favorite tracks from any disc in the player memory. A program can contain 30 tracks.

1. Insert an Audio CD or MP3/WMA files recorded media. AUDIO CD or MUSIC menu appears.
2. Press PROGRAM and the  mark will appear.

Note:

Press PROGRAM again to exit the program edit mode, then the  mark will disappear.

3. Select a track on the “List” and then press ENTER to place the selected track on the “Program” list. Repeat to place additional tracks on the list.
4. Use  /  /  /  to select the track you want to start playing on the “Program” list.
5. Press PLAY () or ENTER to start. Playback begins in the order in which you programmed the tracks. Playback stops after the last track on the “Program” list have played.
6. To resume normal playback from programmed playback, select a track on the list and then press PLAY ().

Repeat Programmed Tracks





Press REPEAT to select a desired repeat mode.

- Track: Repeats the current track.
- All: Repeats all the tracks on programmed list.
- Off(No display): Does not play repeatedly.





Note:

If you press SKIP () once during Repeat Track playback, the repeat playback cancels.

Erasing a Track from Program List

1. During stop mode, press PROGRAM and the  mark will appear
2. Use  /  /  /  to select the track that you wish to erase from the Program list.
3. Press CLEAR. Repeat step 1-3 to erase additional tracks on the list.

Erasing the Complete Program List

1. During stop mode, press PROGRAM and the  mark will appear
2. Use  /  /  /  to select “Clear All” and then press ENTER.

Note:

The programs are also cleared when the power is off or the disc is removed.

Viewing a JPEG file

This unit can play JPEG files.

1. Insert a JPEG files recording media.
The PHOTO menu appears on the TV screen.

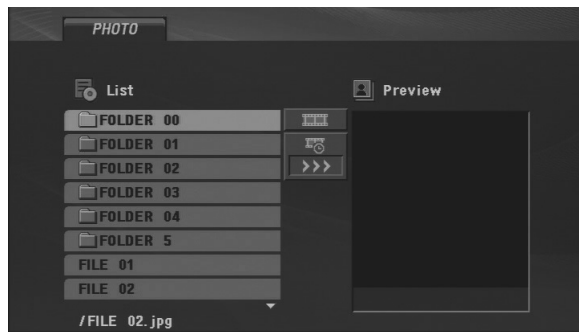

2. Press ▲ / ▼ to select a folder, and press ENTER. A list of files in the folder appears.
3. If you want to view a particular file, press ▲ / ▼ to highlight a file and press ENTER or PLAY (▶).
4. To return to the PHOTO menu while watching pictures, press STOP (■).

Tips:

- If you are in a file list and want to return to the previous Folder list, use ▲ / ▼ buttons to highlight and press ENTER.
- Press DVD MENU to move to the next page.
- There are three Slide Speed options: >>> (Fast), >> (Normal) and > (Slow).
Use ◀ / ▶ / ▲ / ▼ to highlight . Then, use ◀ / ▶ to select the option you want to use.
- On a DISC with MP3/WMA, JPEG and MOVIE file, you can switch MUSIC, PHOTO and MOVIE menu. Press TITLE, and MUSIC, PHOTO or MOVIE word on top of the menu is highlighted.
- While watching a picture, press RETURN (↵) to hide the help menu.

Slide Show

Use ◀ / ▶ / ▲ / ▼ to highlight the (Slide Show) then press ENTER.

Still Picture

1. Press PAUSE/STEP (⏸) during slide show. The player will now go into pause mode.
2. To return to the slide show, press PLAY (▶) or press PAUSE/STEP (⏸) again.

Moving to another file

Press SKIP (⏮ or ⏭) or cursor (◀ or ▶) once during viewing a picture to advance to the next or previous file.

Zoom

During watching pictures, press ZOOM to enlarge the video image (3 steps). You can move through the zoomed picture using ◀ / ▶ / ▲ / ▼ buttons.

Rotating the picture

Press ▲ / ▼ during showing a picture to rotate the picture clockwise or counter clockwise.

Listening to MP3/WMA music while watching picture

1. Insert the disc containing the two types of file in the player.
2. Press TITLE to display the PHOTO menu.
3. Press ▲ / ▼ to select a photo file.
4. Use ▶ to select icon then press ENTER. Playback starts.
5. To return to the PHOTO menu while watching pictures, press STOP (■).

Tip:

To listen to only the desired music while watching picture, program the desired files from the "MUSIC" menu and then proceed as above.

JPEG disc compatibility with this player is limited as follows:

- Photo size: Less than 5 MB recommended
- Depending upon the size and the number of JPEG files, it could take a long time for the DVD player to read the disc's contents. If you do not see an on-screen display after several minutes, some of the files may be too large — reduce the resolution of the JPEG files to less than 5 million pixels and burn another disc.
- The total number of files in a folder should be less than 650 files.
- Some discs may be incompatible due to a different recording format or the condition of disc.
- Ensure that all the selected files have the ".jpg" extensions when copying into the CD layout.
- CD-R/RW, DVD±R/RW Format: ISO 9660
- If the files have ".jpe" or ".jpeg" extensions, please rename them as ".jpg" file.
- File names without ".jpg" extension will not be able to be read by this unit. Even though the files are shown as JPEG image files in Windows Explorer.

Playing a DivX Movie file

This unit can play DivX files.

1. Insert a DivX file recording media.
The MOVIE menu appears on the TV screen.

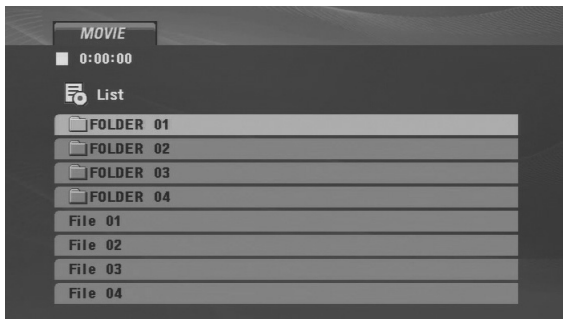

2. Press ▲ / ▼ to select a folder, and press ENTER. A list of files in the folder appears.
3. If you want to view a particular file, press ▲ / ▼ to highlight a file and press ENTER or PLAY (▶). You can use variable playback functions. Refer to page 16-17.
4. Press STOP (■) to stop the playback.
The MOVIE menu appears.

Tips:

- If you are in a file list and want to return to the previous Folder list, use the ▲ / ▼ buttons on the remote to highlight and press ENTER.
- Press DVD MENU to move to the next page.
- On a CD with MP3/WMA, JPEG and MOVIE file, you can switch MUSIC, PHOTO and MOVIE menu. Press TITLE, and MUSIC, PHOTO or MOVIE word on top of the menu is highlighted.
- The disc subtitle may not be displayed properly, if a DivX subtitle is downloaded through the internet.
- If the Disc Subtitle setup menu does not have the DivX subtitle language you are going to play, the subtitle may not be displayed properly.

Notice for displaying the DivX subtitle

If the subtitle does not display properly, please follow the steps below.

1. During playback, press and hold SUBTITLE () for about 3 seconds. The language code will appear.
2. Press ◀ / ▶ to select another language code until the subtitle is displayed properly.
3. Press ENTER.

Note:

The DivX subtitle file name has to be identified with the DivX file name to display by this unit.

DivX disc compatibility with this player is limited as follows:

- Available resolution size of the DivX file is under 720x576 (W x H) pixel.
- The file name of the DivX subtitle is available by 56 characters.
- The total number of files in a folder should be less than 650 files.
- CD-R/RW, DVD±R/RW Format: ISO 9660
- If there is impossible code to express in the DivX file, it may be displayed as “_” mark on the display.
- **If the number of the screen frame is over 30 per 1 second, this unit may not operate normally.**
- **If the video and audio structure of recorded file is not interleaved, either video or audio is outputted.**
- **If the file is recorded with GMC, the unit supports only 1-point of the record level.**
 - * GMC?
GMC is the acronym for Global Motion Compensation. It is an encoding tool specified in MPEG4 standard. Some MPEG4 encoders, like DivX have this option.
There are different levels of GMC encoding, usually called 1-point, 2-point, or 3-point GMC.

Playable DivX file

.avi, .mpg, .mpeg

Playable Subtitle format

SubRip(*.srt/*.txt)
SAMI(*.smi)
SubStation Alpha(*.ssa/*.txt)
MicroDVD(*.sub/*.txt)
SubViewer 2.0(*.sub/*.txt)
TMPlayer(*.txt)
DVD Subtitle System(*.txt)
VobSub(*.sub): Sub/idx, stream based format

Playable Codec format

“DIVX3.xx”, “DIVX4.xx”, “DIVX5.xx”, “MP43”, “3IVX”.

Playable Audio format

- “Dolby Digital”, “PCM”, “MP3”, “WMA”.
- Sampling frequency: within 8 - 48 kHz (MP3), within 22 - 48 kHz (WMA)
 - Bit rate: within 8 - 320 kbps (MP3), 32 - 256 kbps (WMA)
 - Not all the WMA Audio format is compatible with this unit.

Playing a DVD VR format Disc

This unit will play DVD-RW disc that is recorded using the Video Recording (VR) format.

1. Insert a disc and close the tray.
The DVD-VR menu appears on the TV screen

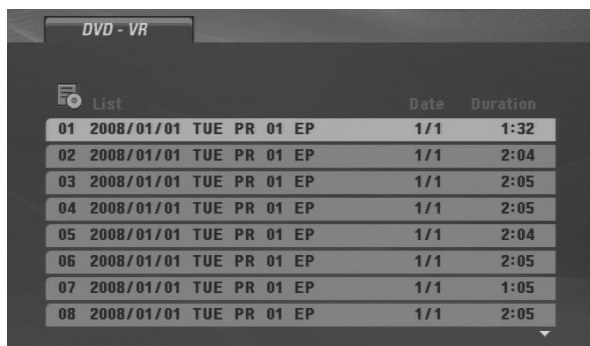

2. Press ▲ / ▼ to select a title then press PLAY (▶) or ENTER and playback starts.
3. Press DVD MENU to move to the list menu.

Notes:

- This unit will play DVD-R/RW disc that is recorded using the DVD-Video format that have been finalized using a DVD-recorder. Unfinalized DVD-R/RW discs cannot be played in this player.
- Some DVD-VR disc are made with CPRM data by DVD RECORDER. Player does not support these kinds of discs.

What is CPRM?

CPRM is a copy protection system (with scramble system) only allowing the recording of 'copy once' broadcast programs. CPRM stands for Content Protection for Recordable Media.

Reference

Remote Control Function

Remote Control C1/C2/C3 Code Switching

This unit is initially set to C3 code (JVC DVD PLAYER code). You can easily change the Remote Control code to C1 (JVC VCR code), C2 (JVC DVD RECORDER code) or C3 as shown below.

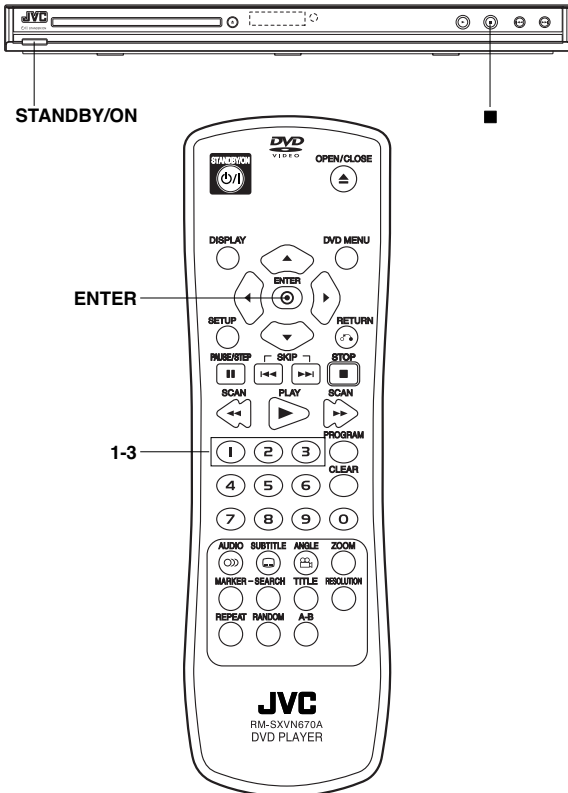

- Keep pressing **ENTER** down during step 1.
- 1. Press the **number Key “1”** for C1, **“2”** for C2 or **“3”** for C3 to change the remote control code.
- 2. Press **STANDBY/ON (⏻)** to turn on the unit.
- 3. Press **■** on the unit for over 5 seconds while the unit is turned on. The code currently set appears on the front display panel.
- 4. Press **ENTER** on the remote control to change the unit's code. The code currently set on the remote control is displayed on the front display panel for approximately 5 seconds, and is applied to the unit.

Note:

If you change the batteries of the Remote Control with C1 or C2 code, the remote control code is set to C3 automatically. In this case, you should reset the remote control code described above.

Maintenance and Service

Refer to the information in this chapter before contacting a service technician.

Handling the Unit

When shipping the unit

Please save the original shipping carton and packing materials. If you need to ship the unit, for maximum protection, re-pack the unit as it was originally packed at the factory.

Keeping the exterior surfaces clean

- Do not use volatile liquids such as insecticide spray near the unit.
- Do not leave rubber or plastic products in contact with the unit for a long period of time, since they leave marks on the surface.

Cleaning the unit

To clean the player, use a soft, dry cloth. If the surfaces are extremely dirty, use a soft cloth lightly moistened with a mild detergent solution.

Do not use strong solvents such as alcohol, benzene, or thinner, as these might damage the surface of the unit.

Maintaining the Unit

The unit is a high-tech, precision device. If the optical pick-up lens and disc drive parts are dirty or worn, the picture quality could be diminished.

Depending on the operating environment, regular inspection and maintenance are recommended after every 1,000 hours of use.

For details, please contact your nearest authorized service center.

Language Codes

Use this list to input your desired language for the following initial settings:
Disc Audio, Disc Subtitle, Disc Menu.

Language	Code	Language	Code	Language	Code	Language	Code
Abkhazian	6566	Fiji	7074	Lingala	7678	Singhalese	8373
Afar	6565	Finnish	7073	Lithuanian	7684	Slovak	8375
Afrikaans	6570	French	7082	Macedonian	7775	Slovenian	8376
Albanian	8381	Frisian	7089	Malagasy	7771	Somali	8379
Ameharic	6577	Galician	7176	Malay	7783	Spanish	6983
Arabic	6582	Georgian	7565	Malayalam	7776	Sudanese	8385
Armenian	7289	German	6869	Maltese	7784	Swahili	8387
Assamese	6583	Greek	6976	Maori	7773	Swedish	8386
Aymara	6588	Greenlandic	7576	Marathi	7782	Tagalog	8476
Azerbaijani	6590	Guarani	7178	Moldavian	7779	Tajik	8471
Bashkir	6665	Gujarati	7185	Mongolian	7778	Tamil	8465
Basque	6985	Hausa	7265	Nauru	7865	Tatar	8484
Bengali; Bangla	6678	Hebrew	7387	Nepali	7869	Telugu	8469
Bhutani	6890	Hindi	7273	Norwegian	7879	Thai	8472
Bihari	6672	Hungarian	7285	Oriya	7982	Tibetan	6679
Breton	6682	Icelandic	7383	Panjabi	8065	Tigrinya	8473
Bulgarian	6671	Indonesian	7378	Pashto, Pushto	8083	Tonga	8479
Burmese	7789	Interlingua	7365	Persian	7065	Turkish	8482
Byelorussian	6669	Irish	7165	Polish	8076	Turkmen	8475
Cambodian	7577	Italian	7384	Portuguese	8084	Twi	8487
Catalan	6765	Japanese	7465	Quechua	8185	Ukrainian	8575
Chinese	9072	Javanese	7487	Rhaeto-Romance	8277	Urdu	8582
Corsican	6779	Kannada	7578	Rumanian	8279	Uzbek	8590
Croatian	7282	Kashmiri	7583	Russian	8285	Vietnamese	8673
Czech	6783	Kazakh	7575	Samoan	8377	Volapük	8679
Danish	6865	Kirghiz	7589	Sanskrit	8365	Welsh	6789
Dutch	7876	Korean	7579	Scots Gaelic	7168	Wolof	8779
English	6978	Kurdish	7585	Serbian	8382	Xhosa	8872
Esperanto	6979	Laothian	7679	Serbo-Croatian	8372	Yiddish	7473
Estonian	6984	Latin	7665	Shona	8378	Yoruba	8979
Faroese	7079	Latvian, Lettish	7686	Sindhi	8368	Zulu	9085

Troubleshooting

Symptom	Possible Cause	Correction
No power.	<ul style="list-style-type: none"> The power cord is disconnected. 	<ul style="list-style-type: none"> Plug the power cord into the wall outlet securely.
The power is on, but the DVD player does not work.	<ul style="list-style-type: none"> No disc is inserted. 	<ul style="list-style-type: none"> Insert a disc. (Check the disc indicator in the display window is lit.)
No picture.	<ul style="list-style-type: none"> Your TV does not accept the resolution that you set on the unit. 	<ul style="list-style-type: none"> Please read TV's owner's manual then use RESOLUTION button to set the resolution that your TV can accept.
	<ul style="list-style-type: none"> The TV is not set to receive DVD signal output. 	<ul style="list-style-type: none"> Select the appropriate video input mode on the TV.
	<ul style="list-style-type: none"> The video cable is not connected securely. 	<ul style="list-style-type: none"> Connect the video cable securely.
No sound.	<ul style="list-style-type: none"> The equipment connected with the audio cable is not set to receive DVD signal output. 	<ul style="list-style-type: none"> Select the correct input mode of the audio receiver so you can listen to the sound from the DVD player.
	<ul style="list-style-type: none"> The power of the equipment connected with the audio cable is turned off. 	<ul style="list-style-type: none"> Turn on the equipment connected with the audio cable.
	<ul style="list-style-type: none"> The AUDIO options are set to the wrong position. 	<ul style="list-style-type: none"> Set the AUDIO option to the correct position, then turn on the DVD player again by pressing STANDBY/ON.
The DVD player does not start playback.	<ul style="list-style-type: none"> An unplayable disc is inserted. 	<ul style="list-style-type: none"> Insert a playable disc. (Check the disc type and regional code.)
The remote control does not work properly.	<ul style="list-style-type: none"> The remote control is not pointed at the remote sensor on the DVD player. 	<ul style="list-style-type: none"> Point the remote control at the remote sensor of the DVD player.
	<ul style="list-style-type: none"> The remote control is too far from the DVD player. 	<ul style="list-style-type: none"> Operate the remote control closer to the DVD player.
	<ul style="list-style-type: none"> The current remote control code does not match the unit. 	<ul style="list-style-type: none"> Identify the remote control code with the code of unit. (See page 23).

Specifications

General

Power requirements:	AC 120 V, 60 Hz
Power consumption:	9 W
Dimensions (Approx.):	430 x 39 x 192 mm (17 x 1.5 x 7.6 inches) (W x H x D) without foot
Net weight (Approx.):	1.5 kg (3.3 lbs)
Operating temperature:	5 °C to 35 °C (41 °F to 95 °F)
Operating humidity:	5 % to 90 %

Outputs

VIDEO OUTPUT:	1.0 V (p-p), 75 Ω, sync negative, RCA jack x 1
S-VIDEO OUTPUT:	(Y) 1.0 V (p-p), 75 Ω, negative sync, Mini DIN 4-pin x 1 (C) 0.3 V (p-p) 75 Ω
COMPONENT VIDEO OUTPUT:	(Y) 1.0 V (p-p), 75 Ω, negative sync, RCA jack x 1 (Pb)/(Pr) 0.7 V (p-p), 75 Ω, RCA jack x 2
HDMI OUTPUT (Video/Audio):	19 pin (HDMI standard, Type A)
AUDIO OUTPUT:	2.0 Vrms (1 KHz, 0 dB), 600 Ω, RCA jack (L, R) x 1
DIGITAL AUDIO OUTPUT:	COAXIAL: 0.5 V (p-p), 75 Ω, RCA jack x 1 OPTICAL: 3 V (p-p), Optical jack x 1

System

Laser:	Semiconductor laser, wavelength 650 nm
Signal system:	NTSC
Frequency response:	DVD (PCM 96 kHz): 8 Hz to 44 kHz DVD (PCM 48 kHz): 8 Hz to 22 kHz CD: 8 Hz to 20 kHz
Signal-to-noise ratio:	More than 90 dB (ANALOG OUT connectors only)
Harmonic distortion:	Less than 0.02%
Dynamic range:	More than 95 dB (DVD/CD)

Accessories

Video cable (1), Audio cable (1), Remote control (1), Batteries (2)

Note: Design and specifications are subject to change without prior notice.

Warranty (Only in U.S.A.)



LIMITED WARRANTY

EXCHANGE-90

JVC COMPANY OF AMERICA warrants this product and all parts thereof, except as set forth below ONLY TO THE ORIGINAL PURCHASER AT RETAIL to be FREE FROM DEFECTIVE MATERIALS AND WORKMANSHIP from the date of the original retail purchase for the period shown below. ("The Warranty Period")

LABOR 90 DAYS	PARTS 90DAYS
----------------------	---------------------

THIS LIMITED WARRANTY IS VALID ONLY IN THE FIFTY (50) UNITED STATES, THE DISTRICT OF COLUMBIA AND IN THE COMMONWEALTH OF PUERTO RICO.

WHAT WE WILL DO:

If this product is found to be defective within the warranty period, JVC will, at its option, either repair or replace the defective part(s) or replace the product with a new or refurbished functionally equivalent product. Within 90 days from date of retail sale, repair or replacement will be at no charge to the customer.

WHAT YOU MUST DO FOR WARRANTY SERVICE:

Please do not return your product to the retailer. Instead, please box the product carefully, preferably in the original carton, and ship, insured to the JVC repair/replacement facility nearest you.

To obtain the address of the location nearest you, please call (800) 252-5722 or visit our website at <http://www.jvc.com>

A COPY OF YOUR BILL OF SALE, A COMPLETED WARRANTY REPAIR/REPLACEMENT FORM AND ALL OF THE ORIGINAL ACCESSORIES WHICH CAME WITH YOUR UNIT MUST ACCOMPANY THE PRODUCT TO BE ELIGIBLE FOR REPAIR/REPLACEMENT UNDER WARRANTY.

If you have any questions concerning your JVC Product, please contact our Customer Care Center at (800) 252-5722.

WHAT IS EXCLUDED:

The warranty does not cover:

1. Products which have been subject to abuse, accident, alteration, modification, tampering, negligence, misuse, faulty installation, lack of reasonable care, or if repaired or serviced by anyone other than a service facility authorized by JVC to render such service, or if affixed to any attachment not provided with the products, or if the model or serial number has been altered, tampered with, defaced or removed.
2. Initial installation, installation and removal, from "built in" entertainment centers, and other mounting systems.
3. Operational adjustments covered in the Owner's Manual, normal maintenance, including head cleaning.
4. Damage that occurs in shipment, due to act of God, and cosmetic damage.
5. Signal reception problems and failures due to line power surge.
6. Products used for commercial purposes (including but not limited to rental).
7. Accessories.
8. Batteries (except that Rechargeable Batteries are covered for 90 days from the date of purchase).
9. Loss of data resultant from malfunction of hard drive or other data storage device.

There are no express warranties except as listed above.

AFTER THE WARRANTY:

Please contact JVC's Customer Care Center at (800) 252-5722 to obtain the cost of out of warranty repair or replacement.

THE DURATION OF ANY IMPLIED WARRANTIES, INCLUDING THE IMPLIED WARRANTY OF MERCHANTABILITY, IS LIMITED TO THE DURATION OF THE EXPRESS WARRANTY HEREIN.

JVC SHALL NOT BE LIABLE FOR ANY LOSS OF USE OF THE PRODUCT, INCONVENIENCE, OR ANY OTHER DAMAGES, WHETHER DIRECT, INCIDENTAL OR CONSEQUENTIAL (INCLUDING, WITHOUT LIMITATION, DAMAGE TO TAPES, RECORDS OR DISCS) RESULTING FROM THE USE OF THIS PRODUCT, OR ARISING OUT OF ANY BREACH OF THIS WARRANTY. ALL EXPRESS AND IMPLIED WARRANTIES, INCLUDING THE WARRANTIES OF MERCHANTABILITY AND FITNESS FOR PARTICULAR PURPOSE, ARE LIMITED TO THE WARRANTY PERIOD SET FORTH ABOVE.

Some states do not allow the exclusion of incidental or consequential damages or limitations on how long an implied warranty lasts, so these limitations or exclusions may not apply to you. This warranty gives you specific legal rights and you may also have other rights which vary from state to state.

JVC COMPANY OF AMERICA
DIVISION OF JVC AMERICAS CORP.

1700 Valley Road
Wayne, New Jersey 07470

<http://www.jvc.com>

REFURBISHED PRODUCTS CARRY A SEPARATE WARRANTY, THIS WARRANTY DOES NOT APPLY. FOR DETAIL OF REFURBISHED PRODUCT WARRANTY, PLEASE REFER TO THE REFURBISHED PRODUCT WARRANTY INFORMATION PACKAGED WITH EACH REFURBISHED PRODUCT.

For customer use:

Enter below the Model No. and Serial No. which is located either on the rear, bottom or side of the cabinet. Retain this information for future reference.

Model No.: _____ Serial No.: _____

Purchase Date : _____ Name Of Dealer : _____



WARRANTY REPAIR / REPLACEMENT FORM

PLEASE COMPLETE THE FOLLOWING;

PLEASE NOTE : P.O. BOXES ARE NOT ACCEPTABLE

NAME: _____

STREET ADDRESS: _____

CITY: _____ STATE _____ ZIPCODE _____

DAY TIME PHONE NUMBER: _____

REASON FOR RETURN _____

Please do not return your product to the retailer. Instead, please box the product carefully, preferably in the original carton, and ship, insured to the JVC repair/replacement facility nearest you.

A COPY OF YOUR BILL OF SALE, A COMPLETED WARRANTY REPAIR/REPLACEMENT FORM AND ALL OF THE ORIGINAL ACCESSORIES WHICH CAME WITH YOUR UNIT MUST ACCOMPANY THE PRODUCT TO BE ELIGIBLE FOR REPAIR/REPLACEMENT UNDER WARRANTY.

To obtain the address of the location nearest you, please call (800) 252-5722 or visit our website <http://www.jvc.com>.

If you have any questions concerning your JVC Product, please contact our Customer Care Center at (800) 252-5722.

BT-51025-6
(0705)

