



## LCD Television Users Guide

**LT-42X579**

**LT-47X579**

**LT-42EM59**

**LT-47EM59**

1080p HDTV

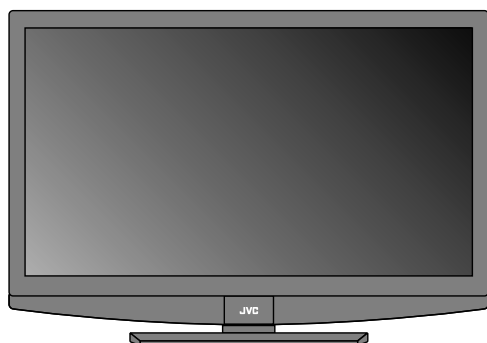

### **Important Note:**

In the spaces below, enter the model and serial number of your television (located at the rear of the television cabinet). Staple your sales receipt or invoice to the inside cover of this guide. Keep this user's guide in a convenient place for future reference. Keep the carton and original packaging for future use.

**Serial Number:** \_\_\_\_\_





**Model Number:** \_\_\_\_\_

LCT2387-001A-A  
0208KTH-II-IM

# Table of Contents

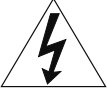
<b>Warnings</b> . . . . .	<b>3</b>	Add Channel . . . . .	31
<b>Precautions</b> . . . . .	<b>6</b>	Edit Channel . . . . .	31
<b>Remote Control</b> . . . . .	<b>10</b>	V-Chip . . . . .	31
<b>TV Basic Controls</b> . . . . .	<b>12</b>	Guide . . . . .	31
<b>Setup</b> . . . . .	<b>16</b>	TV (V-Chip) . . . . .	32
Initial Setup . . . . .	16	Password . . . . .	33
<b>Key Features</b> . . . . .	<b>18</b>	MPEG . . . . .	33
<b>Remote Control Functions</b> . . . . .	<b>19</b>	Can. Eng. . . . .	34
Sleep . . . . .	19	Can. Fre. . . . .	35
Return+ TV . . . . .	19	TVPG . . . . .	36
Favorite . . . . .	19	<b>Sound</b> . . . . .	<b>37</b>
Aspect . . . . .	20	MTS . . . . .	37
Sound . . . . .	20	Digital Audio (ML) . . . . .	37
Video . . . . .	20	Surround . . . . .	37
Guide . . . . .	21	Sound Status . . . . .	38
SUB CH . . . . .	21	Audio Reset . . . . .	38
ML/MTS . . . . .	21	<b>Power</b> . . . . .	<b>39</b>
<b>Customizing your TV</b> . . . . .	<b>22</b>	Sleep Timer . . . . .	39
<b>Picture</b> . . . . .	<b>23</b>	Power Indicator . . . . .	39
Video Status . . . . .	23	Illumination . . . . .	39
Color Temp . . . . .	24	<b>Setting</b> . . . . .	<b>40</b>
Color Management . . . . .	24	Plug-In Menu . . . . .	40
Dynamic Gamma . . . . .	24	Time Zone . . . . .	40
Smart Picture . . . . .	25	D.S.T. . . . .	40
Digital VNR . . . . .	25	Language . . . . .	40
MPEG NR . . . . .	25	Noise Mute . . . . .	40
Natural Cinema . . . . .	25	Front Panel Lock . . . . .	41
Video Reset . . . . .	25	Transparency . . . . .	41
<b>Display</b> . . . . .	<b>26</b>	Auto Shut Off . . . . .	41
Video Input Label . . . . .	26	System Info . . . . .	41
Photo Viewer . . . . .	26	Auto Demo . . . . .	41
Aspect Ratio . . . . .	28	Optical Out . . . . .	41
<b>TV</b> . . . . .	<b>29</b>	<b>Connecting Your Devices</b> . . . . .	<b>42</b>
Closed Caption . . . . .	29	<b>Troubleshooting</b> . . . . .	<b>47</b>
C.C. Setting . . . . .	29	<b>Specifications</b> . . . . .	<b>49</b>
Tuner Mode . . . . .	30	<b>Warranty</b> . . . . .	<b>50</b>
Auto Scan . . . . .	30		

# Warnings

	<b>CAUTION</b> <b>RISK OF ELECTRIC SHOCK</b> <b>DO NOT OPEN</b>	
<b>CAUTION:</b> To reduce the risk of electric shock. Do not remove cover (or back). No user serviceable parts inside. Refer servicing to qualified service personnel.		
	The lightning flash with arrowhead symbol, within an equilateral triangle is intended to alert the user to the presence of uninsulated "dangerous voltage" within the product's enclosure that may be of sufficient magnitude to constitute a risk of electric shock to persons.	
	The exclamation point within an equilateral triangle is intended to alert the user to the presence of important operating and maintenance (servicing) instructions in the literature accompanying the appliance.	

**WARNING:** TO PREVENT FIRE OR SHOCK HAZARDS, DO NOT EXPOSE THIS APPARATUS TO RAIN OR MOISTURE.

**CAUTION:** TO INSURE PERSONAL SAFETY, OBSERVE THE FOLLOWING RULES REGARDING THE USE OF THIS UNIT.

1. Operate only from the power source specified on the unit.
2. Avoid damaging the AC plug and power cord.
3. Avoid improper installation and never position the unit where good ventilation is unattainable.
4. Do not allow objects or liquid into the cabinet openings.
5. In the event of trouble, unplug the unit and call a service technician. Do not attempt to repair it yourself or remove the rear cover.

Changes or modifications not approved by JVC could void the warranty.

- \* When you don't use this TV set for a long period of time, be sure to disconnect both the power plug from the AC outlet and antenna for your safety.
- \* To prevent electric shock do not use this polarized plug with an extension cord, receptacle or other outlet unless the blades can be fully inserted to prevent blade exposure.



- As an "ENERGY STAR<sup>®</sup>" partner, JVC has determined that this product or product model meets the "ENERGY STAR<sup>®</sup>" guidelines for energy efficiency.

# Warnings

## IMPORTANT RECYCLING INFORMATION

This product has a fluorescent lamp that contains mercury. Disposal of these materials may be regulated in your community due to environmental considerations. For disposal or recycling information, please contact your local authorities or for USA, the Electronic Industries Alliance: <http://www.eiae.org>

## IMPORTANT SAFETY INSTRUCTIONS

- 1) Read these instructions.
- 2) Keep these instructions.
- 3) Heed all warnings.
- 4) Follow all instructions.
- 5) Do not use this apparatus near water.
- 6) Clean only with dry cloth.
- 7) Do not block any ventilation openings. Install in accordance with the manufacturer's instructions.
- 8) Do not install near any heat sources such as radiators, heat registers, stoves, or other apparatus (including amplifiers) that produce heat.
- 9) Do not defeat the safety purpose of the polarized or grounding-type plug. A polarized plug has two blades with one wider than the other. A grounding type plug has two blades and a third grounding prong. The wide blade or the third prong are provided for your safety. If the provided plug does not fit into your outlet, consult an electrician for replacement of the obsolete outlet.
- 10) Protect the power cord from being walked on or pinched particularly at plugs, convenience receptacles, and the point where they exit from the apparatus.
- 11) Only use attachments/accessories specified by the manufacturer.
- 12) Use only with a cart, stand, tripod, bracket, or table specified by the manufacturer, or sold with the apparatus. When a cart is used, use caution when moving the cart/apparatus combination to avoid injury from tip-over.
- 13) Unplug this apparatus during lightning storms or when unused for long periods of time.
- 14) Refer all servicing to qualified service personnel. Servicing is required when the apparatus has been damaged in any way, such as power-supply cord or plug is damaged, liquid has been spilled or objects have fallen into the apparatus, the apparatus has been exposed to rain or moisture, does not operate normally, or has been dropped.
- 15) Apparatus shall not be exposed to dripping or splashing and no objects filled with liquids, such as vases, shall be placed on the apparatus.



# Warnings

- 16) Place the television on a stable, flat surface. Failure to do so can result in the television falling, causing injury.
- 17) **DO NOT** allow young children to play around or on the television. Failure to do so can result in the television falling, causing injury.
- 18) **DO NOT** allow young children to play with the plastic bag that came with the television when you unpacked it. Failure to do so can result in suffocation, causing injury.
- 19) Avoid improper installation and never position the unit where good ventilation is impossible. When installing this TV, distance recommendations must be maintained between the set and the wall, as well as inside a tightly enclosed area or piece of furniture. Keep to the minimum distance guidelines shown for safe operation.

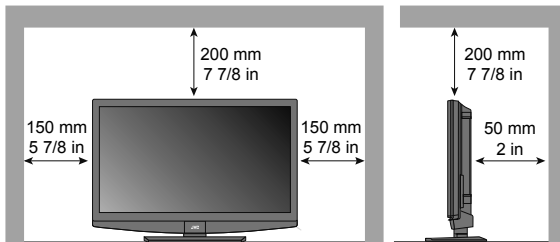

## 20) Cautions for installation

- Do not tilt the TV towards the left or right, or towards the back.
  - Install the TV in a corner on the floor so as to keep cords out of the way.
  - The TV will generate a slight amount of heat during operation. Ensure that sufficient space is available around the TV to allow satisfactory cooling.
- 21) When attaching to a wall, use the optional JVC wall mounting unit.  
For LT-42X579 / LT-42EM59: JVC-XUF-2637 LCD FLAT WALL MOUNT  
For LT-47X579 / LT-47EM59: JVCPCM-MS2 TILT/FLAT WALL MOUNT  
**Caution**
    - Consult qualified installers.
    - See the included manual on mounting procedures.
    - JVC is not responsible for damages or injuries due to improper mounting.
    - Use with other wall mounting unit is capable of resulting in instability or causing possible injury.
  - 22) Make enough room for inserting and removing the power plug. Place the TV as close to the outlet as possible. The main power supply for this TV is controlled by inserting or removing the power plug.
  - 23) Batteries shall not be exposed to excessive heat such as sunshine, fire or the like.
  - 24) When this TV is connected to the wall outlet, it is always on standby even when all the LED lamps are not lit. To shut down the TV, unplug the TV from the wall outlet.

### FCC Notice:

**Caution:** Changes or modifications not expressly approved by party responsible for compliance could void the user's authority to operate the equipment.

# Precautions

We have an important note for customers who subscribe to basic cable services (do not have a separate cable box) and plan to use their JVC TV remote control to select channels.

Once you run the Auto Tuner Setup (which detects and programs all the channels your TV is receiving through the RF input), every channel number available from your cable company will appear in your television's Channel Summary and they will all be marked as available for scanning. Even though every channel is detected and appears as available, you will only be able to view those that you specifically subscribe to from your cable company. This will likely mean there are blank channels between those channels you wish to scan or "surf".

We apologize for any inconvenience this may cause but it is important to note that this is not a malfunction of your television. If you want to sequentially scan those channels you subscribe to without blank ones in between, you can contact your cable company for their cable box and remote, or manually deselect them using the edit / skip feature on page 30.

## Avoiding Temporary Burn-in

Displaying fixed images for extended periods of time can leave a subtle but temporary burn-in image on your screen. To avoid this, mix your viewing pattern.

**Examples include, but are not limited to the following:**

- Stock-market report bars
- Shopping channel logos and pricing displays
- Video game patterns or scoreboards
- Bright station logos
- Internet web sites or other computer-style images
- DVD discs, video tapes, laser discs
- Broadcast, cable, satellite channels or digital television tuners/converters

**For example...**

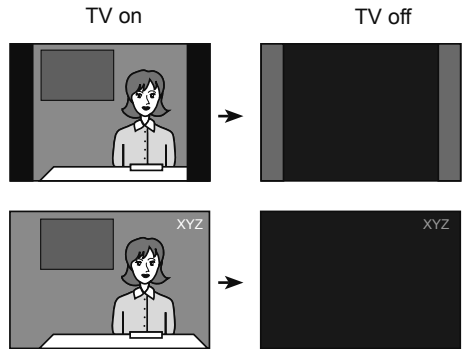

# Precautions

## Caring for the Cabinet

Normally, light dusting with a soft, non-scratching duster will keep your TV clean.

If you wish to wipe down the television, first unplug it. Then wipe gently with a soft cloth, slightly moistened with water. You can add a few drops of mild liquid detergent to the water to help remove spots of oily dirt.

- DO NOT allow liquid to enter the TV through the ventilation slots.
- DO NOT use strong or abrasive cleaners on the TV.
- DO NOT spray liquids or cleaners directly on the TV's surface.
- DO NOT rub or scrub the TV harshly. Wipe the set gently with a soft cloth.

## Caring for the Screen

The screen is treated with an electrostatic-proof coating. When it gets dirty, wipe it gently with a soft cloth. If the screen is very dirty, wipe it down with a cloth dipped in a diluted kitchen cleaner and thoroughly wrung-out. Then wipe immediately after with a clean, dry cloth.

Do not apply alcohol, organic solvents (like acetone), acidic or alkaline cleansers to the screen. These will remove the coating layer and cause discolorations.

Do not push or hit the screen. This could cause scratches on the screen surface and image distortions.

## Tidying the cables

A cable holder which keeps your connection cables tidy is attached to the back of the stand.

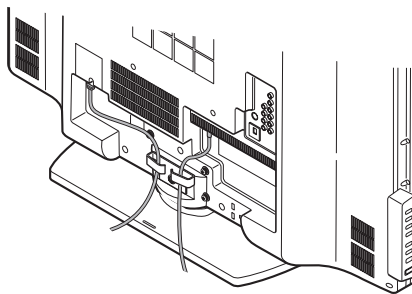

# Precautions

## Disconnecting the stand

If you disconnect the stand, attach the bottom cover and the screw (supplied) into the hole.

- 1) Place the TV face down on a soft cloth on a table.
- 2) Remove the six screws from the back of the TV.

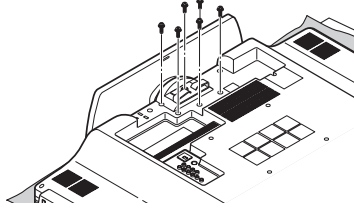

- 3) Pull out the stand from the TV.

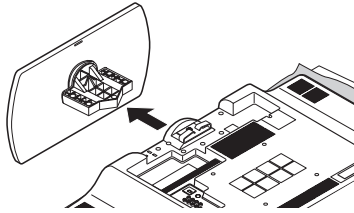

### Note:

- To re-install the stand, reverse the procedure from 3) to 1).



# Precautions

## Package Contents

Make sure you have the following.

Television x 1



Remote Control x 1



AA Batteries x 2



## Insert the batteries

Use two "AA" batteries (included).

Place the "-" end in the unit first, making sure the "+" and "-" markings are correct. Place the "-" end in the unit first.

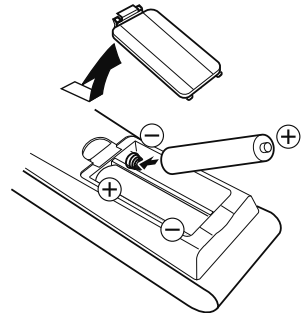

If this symbol is shown, it is only valid in the European Union

# Remote Control

The following pages gives you a brief description of each button's function. For more detailed information on the remote control buttons, see pages 19 - 21.



Change the aspect ratio of the image on your TV screen. See page 20.



Turns the TV on or off.



Switch between devices connected to Video-1, 2, 3, 4 and 5.

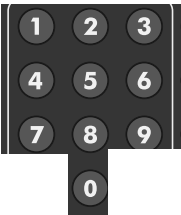

Change channels.



Choose how long the TV will stay on before turning off. See page 19.



Used to select sub channels. **(Digital channels only)**. See page 21.



Listen to a program in stereo, mono or another language (SAP). **(Depending on availability in the program)**. See page 21.



Lets you decide the input channel and select it. After pressing the remote 0 - 9 buttons, press TUNE.



Lets you go back to the previously selected channel. See page 19.



Programming information. **(Digital channels only)**. See page 21.



# Remote Control



Used to navigate through the TV's onscreen menus.



View current channel information.



Used to select the mode of closed caption



Used to access the TV's onscreen menus.  
See page 22.



Go back to a previous onscreen menu or to correct a mistake.



Move sequentially through the channels.



Save your favorite channels. See page 19.



Turns the TV volume to 0. Press again to restore the volume.



Raise or lower the volume.



Choose different display settings according to personal preferences. See page 20.



Choose several types of sound frequencies.  
See page 20.



# TV Basic Controls

Before you connect your television to another device, please refer to the proper diagrams for your specific TV and remote. These will help assist you in understanding how to connect your television to another device, as well as use the remote to set up your television. Some of the connection terminals are color coded for easy connection with the proper cables.

## Front Panel

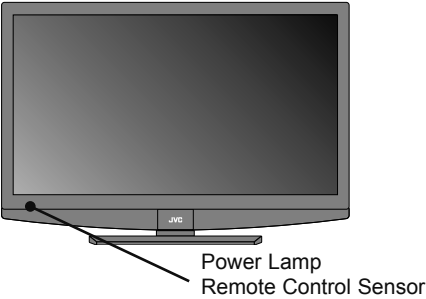

## Side Panel



**Input**  
Change the input

**MENU**  
Used to access the TV's onscreen menus.

**+CH-**  
Move sequentially through the channels.

**+VOL-**  
Raises or lowers the volume.

**POWER**  
Turn the TV on or off.

**Photo Viewer Connector**

- Do not use Photo Viewer connector to connect the iPod



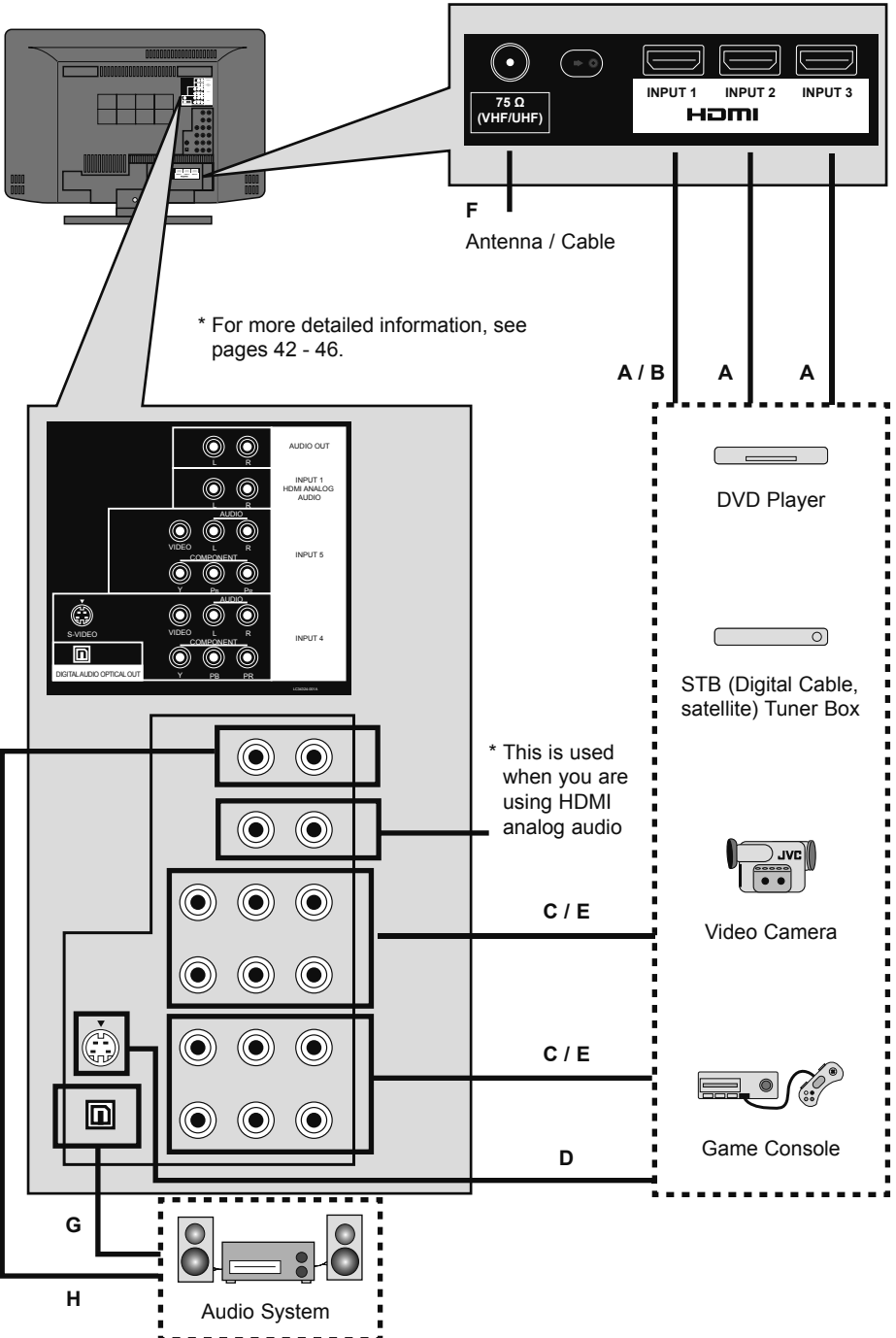







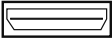

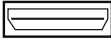
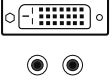
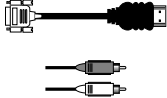
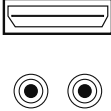
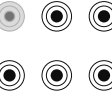
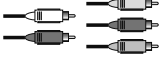
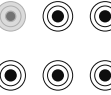
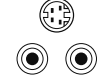
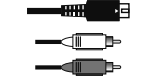

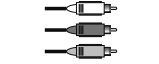
# TV Basic Controls



\* For more detailed information, see pages 42 - 46.

\* This is used when you are using HDMI analog audio

# TV Basic Controls

		Device Side	With Cables	TV Side
<b>VIDEO and AUDIO</b> ↑ Best ↓ Good	A	 HDMI	 HDMI Cable	 INPUT 1, 2 or 3
	B	 DVI + Audio	 DVI – HDMI Cable, Audio Cable	 Input 1 + HDMI ANALOG AUDIO
	C	 Component Video + Audio	 Component Video + Audio	 INPUT 4 or 5
	D	 S-Video + Audio	 S-Video Cable, Audio Cable	 INPUT 4 + AUDIO Input
	E	 Composite Video + Audio	 Composite Video + Audio	 INPUT 4 or 5
	F	 Antenna / Cable (VHF / UHF)	 RF Cable	 75Ω (VHF / UHF)
<b>AUDIO</b> ↑ Best ↓ Good	G	 OPTICAL INPUT	 OPTICAL AUDIO Cable	 DIGITAL AUDIO OPTICAL OUT
	H	 AUDIO INPUT (L / R)	 Audio Cable	 AUDIO OUT (L / R)

# TV Basic Controls

Compatible Signal	Notes
Input <ul style="list-style-type: none"><li>HDMI (Digital)<ul style="list-style-type: none"><li>SD: 480i, 480p</li><li>HD: 1080i, 1080p/60Hz, 720p</li></ul></li><li>Audio L/R</li></ul>	See page 46.
Input <ul style="list-style-type: none"><li>DVI (Digital)<ul style="list-style-type: none"><li>SD: 480i, 480p</li><li>HD: 1080i, 1080p/60Hz, 720p</li></ul></li><li>Audio L/R (Analog)</li></ul>	See page 45.
Input <ul style="list-style-type: none"><li>Component (Analog)<ul style="list-style-type: none"><li>SD: 480i, 480p</li><li>HD: 1080i, 720p</li></ul></li><li>Audio L/R (Analog)</li></ul>	See page 43.
Input <ul style="list-style-type: none"><li>S-Video (Analog)</li><li>Audio L/R (Analog)</li></ul>	
Input <ul style="list-style-type: none"><li>Composite (Analog)</li><li>Audio L/R (Analog)</li></ul>	See page 43.
ATSC (Digital) NTSC (Analog) Clear QAM (Digital)	See page 42.
Output <ul style="list-style-type: none"><li>Audio L/R (Digital) (PCM or Dolby Digital)</li></ul>	See page 44.
Output <ul style="list-style-type: none"><li>Audio L/R (Analog) (Fixed)</li></ul>	See page 44.

# Setup

## Initial setup

When you turn on your TV for the first time, the Initial Setup menu appears automatically. These menus will help you setup your TV with basic information for **Language**, **Time** and **Tuner Setup**. You can also set this setting in the “Plug in Menu”.



### 1) Turn on the TV



### 2) Set the language

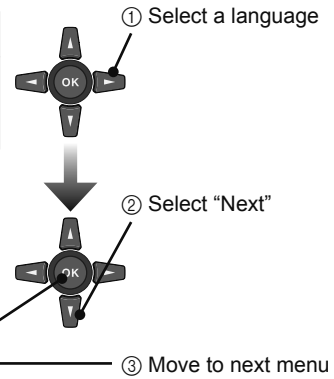
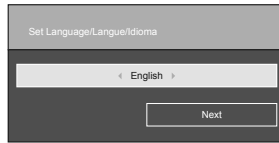

### 3) Set time attribute

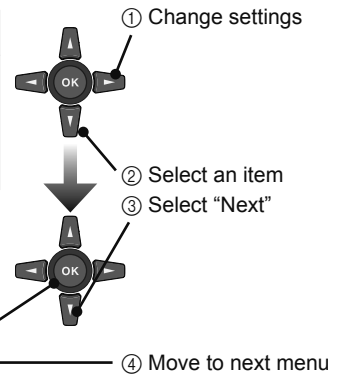
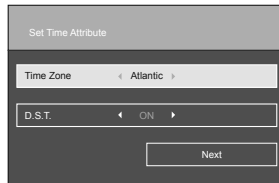

Time Zone	Choose the time zone you live in.
D.S.T.	Changes the clock automatically for daylight saving time. <b>On / Off</b>



## Initial setup (Continued)



### 4) Set TV attribute

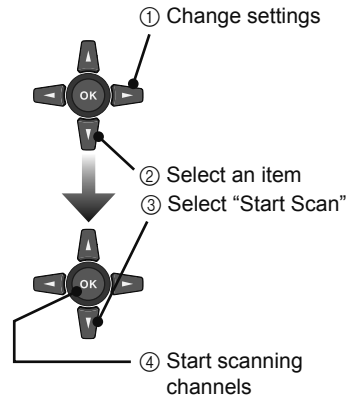
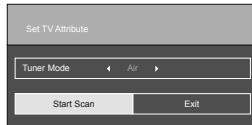

Tuner Mode	Choose Air (antenna) or Cable
------------	-------------------------------

\* If you use a set top box (satellite or cable box), press "Exit" to skip this step.

**Cable Users:** After your auto tuner setup is complete, you may, (depending on the type of hookup), have only 1 channel, usually 2, 3 or 4 in the auto tuner memory. This is normal.

**"Thank you! Setup is now complete"**

# Key Features

Your JVC TV is equipped with many features. Here is some key features highlighted in detail.

- 1 Stunning picture quality via 1920x1080 Full HD panel. Dynamic Gamma and Color Management give further fine tuned picture reproduction. Smart Picture adjusts the best possible picture quality automatically scene by scene based on the incoming signal from any source!



- 2 JVC exclusive oblique cone speakers provide excellent TV sound quality. OmniSurround sound provides you 4 different settings based on the program you are watching. The equalizer will fine tune your listening preferences.



- 3 Full connectivity with 3 HDMI, 2 Component, 1 S-video and others. The variety of connections are explained in pages. 42 to 46.

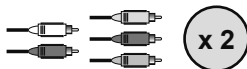

- 4 Aspect mode will show every pixel you are getting in High Definition. The Native mode will show 100% of 1080p. Full – with slight overscan. Panarama, Cinema will fill the screen with various aspect settings.



**Full or Widescreen Mode**

# Remote Control Functions



## Sleep

---

Allows you to choose how long the TV will stay on before turning off.

### Notes:

- When you press the **SLEEP** button several times, you can set the interval at Off, 15, 30, 45, 60, 90, 120, 150 and 180 minutes.
- 60 seconds before the TV turns off, a message will appear and it will count the remaining time. If you want to extend the time, press the **SLEEP** button and you can change the interval. If you don't press the **SLEEP** button, within 60 seconds the TV will turn off.



## Return+ TV

---

Has three functions.

**Return** – Returns to the channel viewed just before the channel currently onscreen.

**Return+** – Lets you program a specific channel to return to while scanning through the channels using the **- CH +** button as you memorize the channel.

**TV** – Returns to the TV mode as you are watching a video, DVD, etc.

### Note:

- Press **TUNE** and **RETURN+ TV** buttons. This will memorize the current channel to return to while you scan through the other channels. To cancel, press **TUNE** and **RETURN+ TV** buttons again.



## Favorite

---

Allows you to save channels you like so you can view them easily. First you must register the channels you like.

### Notes:

- Go to the channel you want to register and press the **FAVORITE**. A list will appear. Press the **FAVORITE** button again to register your channel.
- To view your favorite channels, press **FAVORITE**. Move **▲ ▼** to select your channel and press **OK**.
- To erase your favorite channels, press **FAVORITE**. Move **▲ ▼** to select your channel and press **▶**.
- Both analog and digital channels can be registered.
- The channels you registered will appear in numerical order at the top of the list.

# Remote Control Functions



## Aspect

---

Allows you to adjust the way the image appears on your TV based on the format that is being received.

**Panorama / Cinema / Full / Panorama Zoom / Cinema Zoom / Full Native / Regular / Slim**

See page 28.

### Notes:

- You can select the aspect mode by pressing the **ASPECT** button.
- You can also access the aspect modes using the buttons on the side of the TV, by using the **MENU** button, then the **- CH +** button.



## Sound

---

You can choose several types of sound modes. **Speech / Jazz / Classic / Rock / User**

### Notes:

- You can choose the different sound modes by pressing the **SOUND** button.
- If you select **User**, you can customize the various sound frequencies.



## Video

---

Allows you to choose different picture settings according to personal preferences. You can access this feature for each input (TV, V1, V2, V3, V4, V5).

**Standard / Dynamic / Theater / Game**

See page 23.

# Remote Control Functions



## Guide

---

You can view program information for Digital Channels.

### Note:

- When the program information is not being broadcast, the correct information will not be displayed.
- The GUIDE will not show the correct time and date depending on the Time Zone and D.S.T. settings. See page 40.



## SUB CH

---

Digital broadcast sometimes offers sub channels. By using the **SUB CH** button, you can select a sub channel easily.

For example, to move to sub channel 123-45:

- 1) Press **1**, **2** and **3** in order
- 2) Press the **SUB CH** button
- 3) Press **4** and **5** in order
- 4) Press the **TUNE** button



## ML/MTS

---

Allows you to listen to a program in stereo, mono sound or another language (SAP) if available. First you must set the **MODE** to **TV** on your remote.

### Notes:

- When you are receiving a digital broadcast, if there are other languages, you can change the language by pressing the **ML/MTS** button.
- Keep the TV in stereo mode to get the best sound quality. The sound will work in stereo mode even if a certain broadcast is in mono sound only.
- Choose the mono setting to reduce excessive noise on a certain channel or broadcast.
- MTS is unavailable if your television's Input source is (**V1**, **V2**, **V3**, **V4**, **V5**).
- ML/MTS will not work when you are using HDMI.

# Customizing your TV



## 1) Display the menu bar

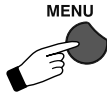

## 2) Display the desired menu

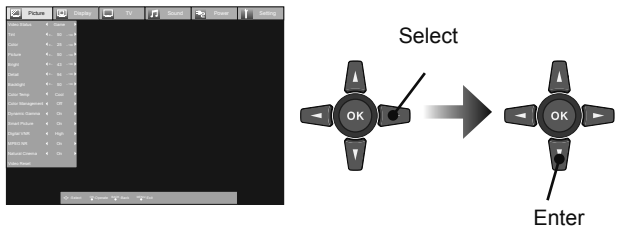

## 3) Change or adjust the setting

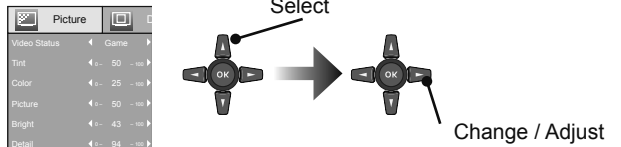

■ To enter an item's sub menu

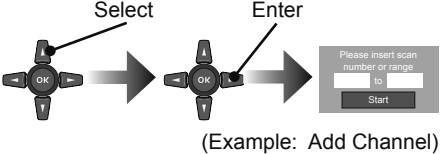

■ To the previous screen



## 4) Close the menu

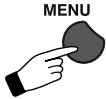

**Note:**

- Depending on the situation (analog channels, digital channels, video signal format, external inputs, etc.), some items will be displayed in gray and can not be selected.

# Customizing your TV

## Picture



## Video Status

Choose different display settings according to personal preferences. You can use this feature with TV, V1, V2, V3, V4 and V5.

### Standard

Resets the picture display to the factory settings.

### Dynamic

Gives a vivid picture with better contrast when viewing in a brightly lit room.

### Theater

Gives a rich, film-like look to video when viewing in a dimly lit room.

### Game

Used for when you are playing video games connected to your TV.

### Notes:

- Each mode is memorized for each input (TV, V1, V2, V3, V4, V5) connected to the TV.
- Each video status setting has a separate memory for HD (1080i/1080p/720p) and SD (480p/480i) video signal. Each video status can be chosen along with your favorite picture settings (Tint, Color, Picture, Bright, Detail and Backlight).
  - When an HD or SD signal is displayed, your HD or SD settings are recalled for the video status you are using.

# Customizing your TV

## Picture (Continued)

- Allows you to change and adjust the way the picture appears on your television.

### Tint

Allows you to adjust the levels of red and green on your TV.

### Color

Allows you to make all the colors on your TV appear more vivid or subtle.

### Picture

Allows you to adjust the level of black and white on your TV giving you a darker or brighter picture overall.

### Bright

Allows you to adjust the overall brightness of the TV.

### Detail

Allows you to adjust the level of fine detail on your TV.

### Backlight

Allows you to adjust the brightness of the internal lamp which effects the overall brightness of the TV.

## Color Temp

Allows you to change how strong or dull the colors appear. **Cool / Natural / Warm**

## Color Management

Allows you to compensate for dull colors to ensure dull colors are reproduced with natural hues.

**On / Off**

## Dynamic Gamma

Allows you see more detail in very dark or bright areas so these areas don't appear "muddied". Normally, this feature should be left **On** for optimum picture quality. **On / Off**



# Customizing your TV

## Picture (Continued)

### Smart Picture

Allows you to adjust the brightness level automatically to a level suitable for what you are watching. **On / Off**

### Digital VNR

This function can be selected to change the effect of Digital VNR (Video Noise Reduction).

**High** – Adjusts the effect maximally

**Low** – Adjusts the effect minimally

### MPEG NR

This function effects the block noise removal and mosquito NR (Noise Reduction) simultaneously.

**Note:**

- When you are receiving digital channels, block noise removal will have no effect.

### Natural Cinema

Allows you to compensate for image blurring when the original video you are watching was shot at 24 frames/sec, and is broadcast at 30 frames/sec. This conversion error is known as "TELECINE". **On / Off**

**Notes:**

- When you are receiving a 480p, 720p or 1080p signal, Natural Cinema cannot be selected.
- Natural Cinema is only applied for SD 480i and HD 1080i signals.

### Video Reset

Resets all picture adjustments at once to the default settings, except for Natural Cinema.

# Customizing your TV

## Display



## Video Input Label

Allows you to label all the devices you have connected to the TV that use the VIDEO-1, 2, 3, 4 and 5 inputs.

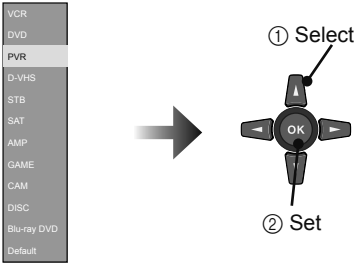

## Photo Viewer

Connect your USB Mass Storage Class device to the Photo Viewer terminal on the TV.

Photo Viewer allows you to enjoy your digital pictures stored on your USB Mass Storage Class devices. You can view them on the TV in high quality.

1) Choose Slide Show Interval of 5, 10 or 20 seconds by pressing the ◀ ▶ buttons.

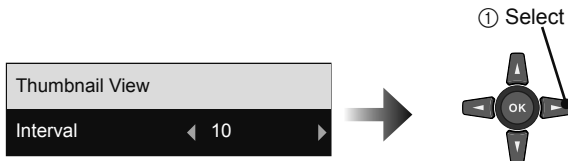

# Customizing your TV

## Display (continued)

2) Choose Thumbnail View by pressing the ► button, and a folder list will be displayed. Select your folder by using the ◀► or ▲▼ buttons. The screen will show the first 10 images.

\* If there is more than 10 images, those images will be shown in the next page. To go to the next page, select the last image on the page and press the ► or ▼ buttons. To go back to the previous page, press the ◀ or ▲ buttons.

3) Choose a picture and press the **OK** button. It will now be shown on the screen. To move to the next picture, press the ► or ▼ buttons. To move to the previous picture, press the ◀ or ▲ buttons.

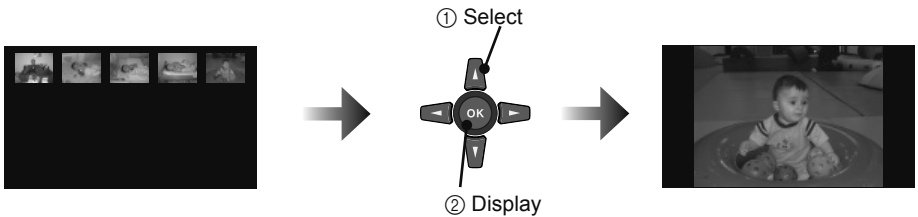

**2** 90° Rotation

**4** 180° Rotation

**8** 270° Rotation

**6** 360° Rotation

**TUNE** Start Slideshow

4) To go back to main menu, press the **MENU** button.

### Notes:

- Please pull out your USB device from the Photo Viewer terminal after finishing the “Photo Viewer” menu.
- Use the supplied USB cable that came with your device. Do not use HUB or USB extension cable.
- Photo Viewer cannot be guaranteed to work with all USB Mass Storage Devices. It may take some time to display or it may not display correctly.
- Please refer to the Customer Support website at [www.jvc.com/support](http://www.jvc.com/support) for information and notes regarding your devices you wish to connect.
- Supported file formats are “.jpg” or “.JPG”.
- All your stored data should be backed up first as a precaution before connecting to the TV.
- Depending on your stored file size, it can take extra time to display “Photo Viewer” page.
- You can not display photos using the SD card from the JVC Everio Camera.

# Customizing your TV

## Display (continued)

### Aspect Ratio

Allows you to adjust the way the image appears on your TV based on the format that is being received.

**Panorama** - When watching a 4:3 aspect picture it is stretched to fit the dimensions of the 16:9 aspect screen.

**Cinema** - This ratio “zooms in” on the center part of a 4:3 aspect picture, blowing it up proportionally to fill the 16:9 screen.

**Full** - When watching a 4:3 aspect picture, it is stretched to fit the dimensions of the TV. When watching a 16:9 aspect picture, it displays 95% of the ratio.

**Panorama Zoom** - When watching a High-Definition 16:9 aspect picture it is stretched to eliminate the black side bars.

**Cinema Zoom** - This ratio “zooms in” on the center part of a High-Definition 16:9 aspect image to eliminate the black surrounding bars.

**Full Native** - This ratio displays 100% of the ratio. Normally, all aspects except for **Full Native** display about 95%.

**Regular** - When watching a 4:3 aspect picture without modifying the original picture to fit the dimensions of your 16:9 screen. Black bars will appear along the picture’s sides. The picture will be centered within the boundaries of the 16:9 screen.

**Slim** - This aspect mode shrinks the screen of a 16:9 broadcast to 4:3. There are some programming that is already stretched by mistake at broadcasting companies, so this mode corrects it. Black side bars will appear.

#### Notes:

- Depending on the signal format, some aspect modes are unavailable.
- Slim can only be displayed when the signal is ATSC (480i, 480p, 720p, 1080i) or HD (720p, 1080i).
- If the television receives a 16:9 signal from your HDMI device, the aspect mode will turn to Full automatically. If the television receives a 4:3 signal from your HDMI device when you are in Full aspect mode, it will return to Regular aspect mode. If you change the aspect mode after the television changed it to Full automatically, the television will change to the aspect mode you choose. It also turns to Full automatically when the TV receives an HD (1080i or 720p) signal.
- You can access the aspect modes using the buttons on the side of the TV, by using the **MENU** button, then – **CH +** button.

# Customizing your TV

## TV



## Closed Caption

Allows you to select the mode of the closed caption. First you must set the **MODE** to either **TV**, **STB** or **VCR** on your remote. **On / Smart / Off**

## C.C. Setting

You can choose between caption or text in MODE to decide how closed captioning will appear.

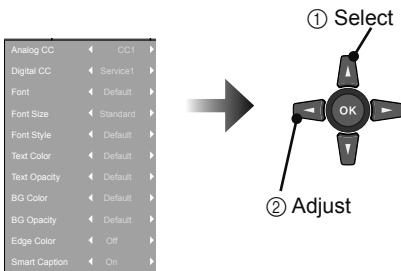

# Customizing your TV

## TV (continued)

### Analog CC

Choose the CC feature that you like for analog Closed Captioning.

### Digital CC

Choose the CC feature that you like for digital Closed Captioning.

### Font

Choose the font that you like for Closed Captioning.

### Font Size

Choose how big the text appears in Closed Captioning.

### Font Style

Choose the style of the font in Closed Captioning.

### Text Color

Choose the color of the text in Closed Captioning.

### Text Opacity

Choose how translucent the text appears in Closed Captioning.

### BG Color

Choose the background box color for the Closed Captioning text.

### BG Opacity

Choose how translucent the background box color for the Closed Captioning text.

### Edge Color

Choose the color of the border of the background box color for the Closed Captioning text.

### Smart Caption

Will display closed captioning when you press the MUTING button only on channels where the broadcast contains closed captioning.

## Tuner Mode

If you skipped this step in the initial setup or your setup has changed, you can redo your setup in this menu. **Air / Cable**

## Autoscan

Allows you to scan through all available channels your TV can receive, and memorizes them.

### Note:

- The Autoscan is finished when the message **Scanning has completed** appears on the screen.

# Customizing your TV

## TV (continued)

### Add Channel

Allows you to add analog channels. Regarding digital channels, the only channels that will appear are the ones that are being broadcast.

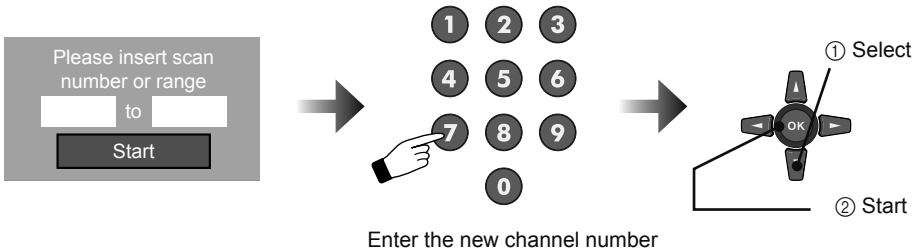

### Edit Channel

Allows you to skip channels when using the + CH – button. "✓" means don't skip, " " means to skip. You can still access those skipped channels manually using the number buttons on the remote.

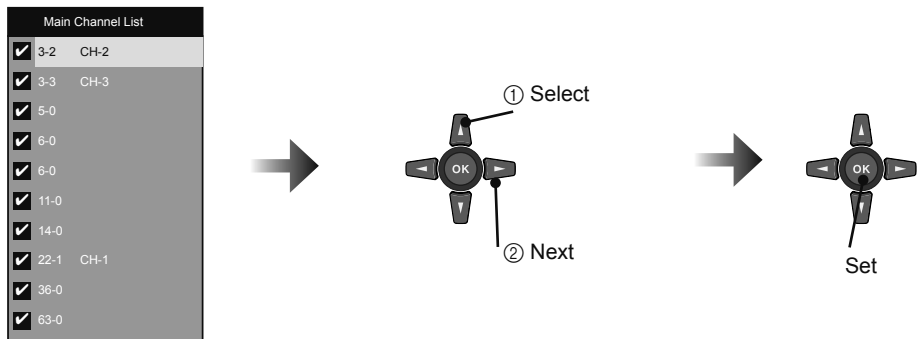

### V-Chip

Allows you to block channels or content that you deem inappropriate for children. See pages 32 – 36.

### Guide

You can view program information. **(Digital channels only).**

#### Note:

- If the programming information is not being broadcast, the guide function has no effect or may display incorrect information.

# Customizing your TV

## TV (V-Chip)

Allows you to block channels or content that you deem inappropriate for children.

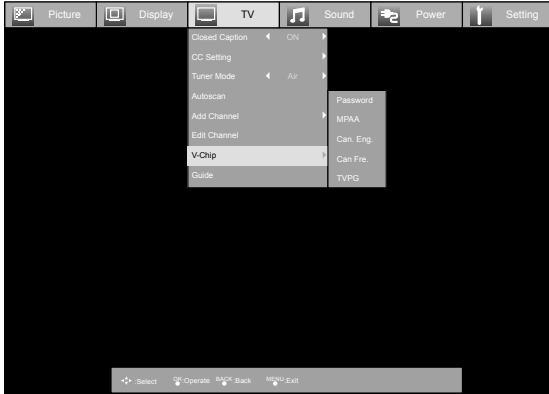

### Notes:

- V-CHIP will not work with video signals from VCRs, DVD players, Blu-ray, HD DVD players or camcorders connected to the TV.
- **(For Canadian viewers only):** V-CHIP is designed specifically for the US and may not work properly in Canada.

### – When entering the password –

When you try and access the V-Chip menu, “Please input password” will appear. Press the “0” button four times on your remote to access the V-Chip menu for the first time.

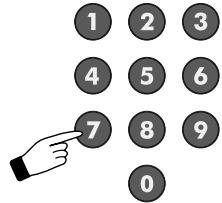
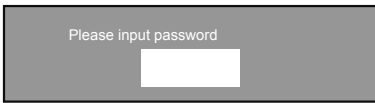

### – When you lock or unlock channels –

You can lock or unlock ratings as shown below.

Password	NR	
MPAA	G	
	PG	
Can. Eng.	PG13	
Can Fre.	R	
	NC-17	
TVPG	X	



2 Lock / Unlock

### Note:

- If you lock a rating, any rating that is higher is automatically blocked.



# Customizing your TV

## TV (V-Chip) (continued)

### Password

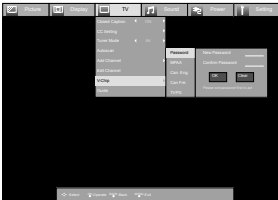

You can change the four digit password using the number buttons on your remote.

\* If you forget your password, unplug the TV from the wall and then plug it back in. Your password will reset to "0000"

#### 1) Set a new password

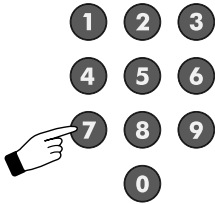

Enter the four digit number



#### 2) Confirm and set

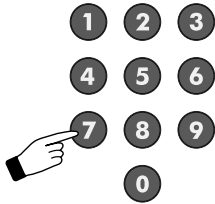

Enter the four digit number



### MPAA

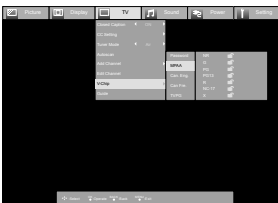

This setting is based on the US Motion Picture Association of America (MPAA) ratings system.

# Customizing your TV

## TV (V-Chip) (continued)

### MPAA (continued)

**NR – Not Rated.**

Any type of programming that does not contain a rating.

**G – General Audience.**

Suitable for all ages.

**PG – Parental Guidance Suggested.**

Suitable for all ages with parental guidance.

**PG 13 – Parents Strongly Cautioned.**

Intended for viewers 13 years or older.

**R – Restricted.**

Not recommended for viewers 17 years without parental guidance.

**NC-17 – No One Under 17.**

Not intended for viewers 17 years or younger.

**X – No One Under 18.**

Not intended for viewers 18 years or younger.

**Viewing Guidelines:**

At the beginning of a program, the program will display its rating and the content it contains. **(Except for unrated programming).**

A program can contain any or all of the following:

**V/FV – VIOLENCE/FANTASY VIOLENCE**

**S – SEXUAL CONTENT**

**L – Strong LANGUAGE**

**D – Suggestive DIALOG**

## Can. Eng.

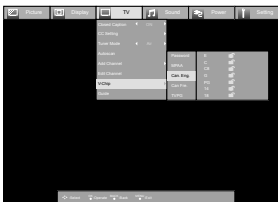

This setting is based on the Canada ratings system.

# Customizing your TV

## TV (V-Chip) (continued)

### **E – Exempt.**

Any type of programming that does not contain a rating.

### **C – Intended for children.**

Suitable for all ages.

### **C8+ – Intended for children over 8 years old.**

Suitable for all ages over 8 years.

### **G – General Audience.**

May contain material not suited for younger viewers.

### **PG – Parental Guidance.**

May contain material not suited for younger viewers. Parents may consider some content not appropriate for children 8 - 13 years old.

### **14+ – 14 Years or Older.**

Parents strongly urged to use their discretion in allowing viewing by persons under 14.

### **18+ – Adult.**

Intended for viewers 18 years or older.

## Can. Fre.



This feature is the same as **V-CHIP (SET CANADIAN RATINGS ENG)**, but in French.

# Customizing your TV

## TV (V-Chip) (continued)

### TVPG



This setting is based on the US ratings system.

#### **TV Y – Appropriate for all children.**

Intended for all children 2 - 6 years old.

#### **TV Y7 – Appropriate for older children.**

Intended for children 7 years or older.

#### **TV G – General Audience.**

Suitable for all ages.

#### **TV PG – Parental Guidance Suggested.**

Suitable for all ages with parental guidance.

#### **TV 14 – Parents Strongly Cautioned.**

Intended for viewers 14 years or older.

#### **TV MA – Mature Audiences Only.**

Intended for viewers 18 years or older.

#### **Viewing Guidelines:**

In addition to the above ratings, you can also block or allow more specific content. **(Except for unrated programming).**

A program can contain any or all of the following:

**V/FV – VIOLENCE/FANTASY VIOLENCE**

**S – SEXUAL CONTENT**

**L – Strong LANGUAGE**

**D – Suggestive DIALOG**

# Customizing your TV

## Sound



## MTS

Allows you to listen to a program in stereo, mono sound or another language (SAP).  
**(Depending if available in the program)**. First you must set the **MODE** to **TV** on your remote.

### Notes:

- When you are receiving a digital broadcast, if there are other languages, you can change the language by pressing the **ML/MTS** button.
- Keep the TV in stereo mode to get the best sound quality. The sound will work in stereo mode even if a certain broadcast is in mono sound only.
- Choose the mono setting to reduce excessive noise on a certain channel or broadcast.
- MTS unavailable if your television's input source is **(V1, V2, V3, V4, V5)**.
- ML/MTS will not work when you are using the HDMI.

## Digital Audio (ML)

You can change the language if there are other languages available. **(Digital channels only)**

## Surround

You can select the surround mode you like. **Movie / Music / News / Mono / Off**

# Customizing your TV

## Sound (continued)

### Sound Status

You can choose several types of sound modes. **Speech / Jazz / Classic / Rock / User**

**Note:**

- If you select **User**, you can customize the various sound frequencies.

### Audio Reset

Resets all sound adjustments at once to the default settings.

# Customizing your TV

## Power

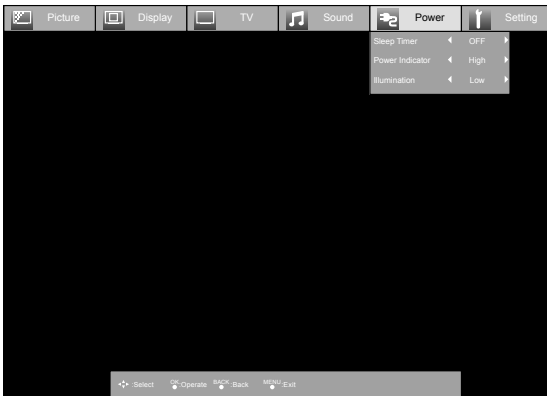

## Sleep Timer

Allows you to choose how long the TV will stay on before turning off. First set the **MODE** to **TV**.  
**Off / 15Min / 30Min / 45Min / 60Min / 90Min / 120Min / 150Min / 180Min**

### Note:

- 60 seconds before the TV turns off, a message will appear and it will count the remaining time. If you want to extend the time, press the **SLEEP** button and you can change the interval. If you don't press the **SLEEP** button, within 60 seconds the TV will turn off.

## Power Indicator

Allows you adjust the brightness of the blue power indicator light.

**High** – Light is brightly lit

**Low** – Light is dimly lit

**Off** – Light is off

## Illumination

Allows you adjust the brightness of the center blue light around the TeleDock.

**High** – Light is brightly lit

**Low** – Light is dimly lit

**Off** – Light is off

# Customizing your TV

## Setting



## Plug-In Menu

When you turn on your TV for the first time, the Initial Setup menu appears. If you skip it, or your setup has changed, you can set it up in this menu anytime.

## Time Zone

Choose the time zone you live in and the clock sets automatically.  
**Atlantic / Eastern / Central / Mountain / Pacific / Alaska / Hawaii**

## D.S.T.

Adjust your TV's clock for Daylight Savings. **On / Off**

## Language

Allows you to change the TV's onscreen menu languages to English, French or Spanish.

## Noise Mute

Displays a blank gray screen over channels that are too weak to be received clearly.  
**On / Off**



# Customizing your TV

## Setting (continued)

### Front Panel Lock

This allows you to lock the buttons on the side of the TV. **On / Off**

### Transparency

Change the transparency of the menu screens. **1 / 2 / 3 / 4**

### Auto Shut Off

This function automatically shuts off your TV when there is no signal from the channel while the TV is on for 10 minutes. **On / Off**

### System Info

You can confirm the TV's software version.

### Auto Demo

Auto Demo explains this TV's features to you.

#### Notes:

- Please complete the Initial Setup menu first. The Auto Demo mode will start automatically when the Initial Setup menu is completed.
- If you press any button on the television or remote, with the exception of POWER or MENU, the Auto Demo mode will stop for 30 seconds. After 30 seconds have passed with no operation, the Auto Demo mode will start again.
- If you want to turn off the Auto Demo, press the **MENU** button.

### Optical Out

You can select the optical digital sound output as PCM or DOLBY DIGITAL when your TV is connected to an amplifier that has a DOLBY DIGITAL decoder. If you select DOLBY DIGITAL, you can enjoy listening to 5.1ch sound when watching digital broadcasts. This only applies to digital channels.

#### Notes:

- If your amplifier does not have DOLBY DIGITAL decoder, select PCM. If you don't select PCM, it cannot output the sound from the speakers.
- For connecting an amplifier using the optical output, see page 44.



Manufactured under license from Dolby Laboratories. "Dolby", and the double-D symbol are trademarks of Dolby Laboratories.

# Connecting Your Devices

**Notes:**

- The following connection diagrams are examples on connecting some of the most common devices to your TV. Please refer to your device's instruction manual on other connection methods or for devices not shown here in this instruction book.
- When you are finished connecting your devices, turn on your TV and devices.

## Connect an Antenna or Basic Cable

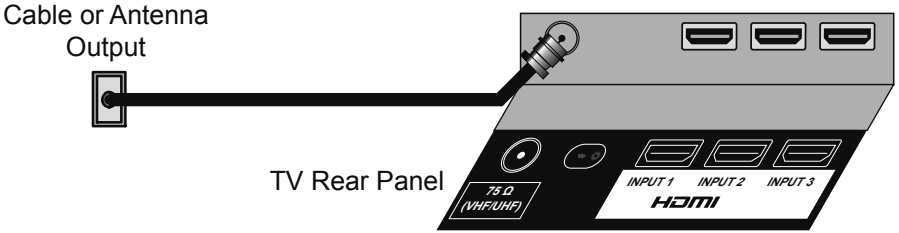

**Notes:**

- If you are able to receive ATSC (Digital terrestrial) signal, High Definition (HD) broadcasting can be watched.
- All digital broadcasting is not necessary High Definition. Check by pressing the **DISPLAY** button.
- Digital broadcasting is not available in all areas.

## Connect a Cable Box

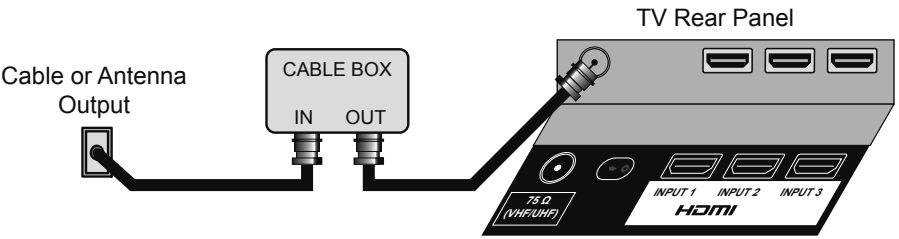

**Note:**

- To view channels on your cable box, make sure your TV's channel is set to 2, 3 or 4 (depending on the area you live in).

# Connecting Your Devices

## Connect a DVD Player

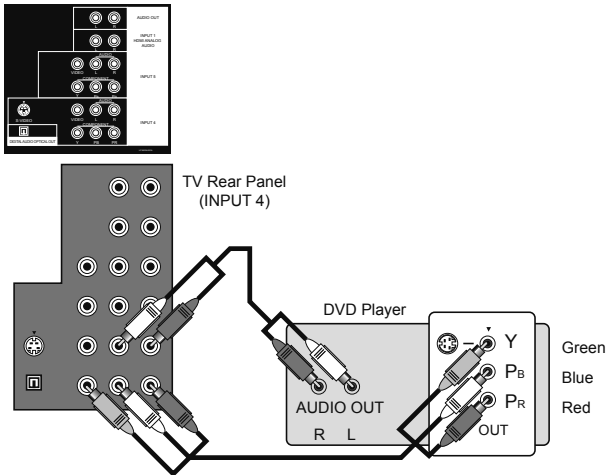

### Notes:

- Green, blue and red are the most common colors for Component Cables. Some models may vary in color.
- To watch your DVD player, make sure your TV is displaying INPUT 4 or INPUT 5 by pressing the **V4** or **V5** button on your remote control.

## Connect a Camcorder

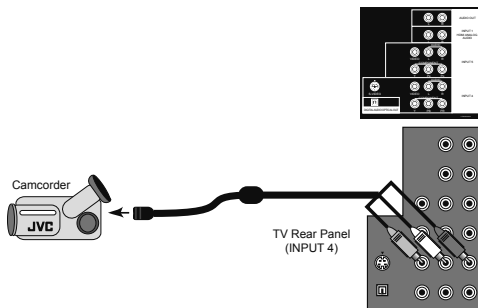

### Note:

- To watch video from your camcorder, make sure your TV is displaying INPUT 4 or INPUT 5 by pressing the **V4** or **V5** button on your remote control.

# Connecting Your Devices

## Connect an Amplifier or Home Theater System

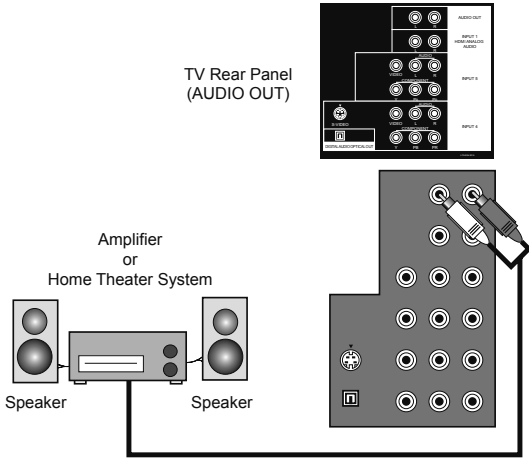

### Notes:

- Refer to your amplifier's or Home Theater System's manual for more information.
- If you have a device connected to INPUT 1, INPUT 2 or INPUT 3, you will not be able to hear any audio from the AUDIO OUT on the back of the TV otherwise.

## Connect an Amplifier using the DIGITAL AUDIO OPTICAL OUT

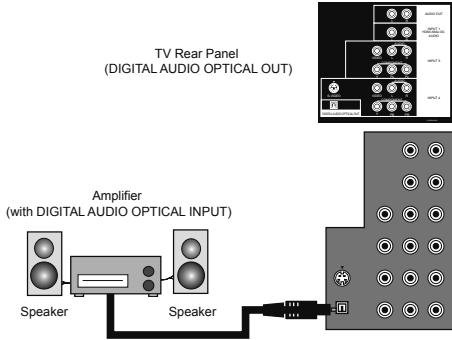

### Notes:

- Refer to your amplifier's manual for more information.
- This terminal can only output digital audio (PCM or DOLBY DIGITAL).
- In order to use the optical output connection, select PCM or DOLBY DIGITAL. See page 41.
- You can not output sound from your DIGITAL AUDIO OPTICAL OUTPUT connection if the audio source is from your HDMI device.

# Connecting Your Devices

## Connect a Digital TV Device

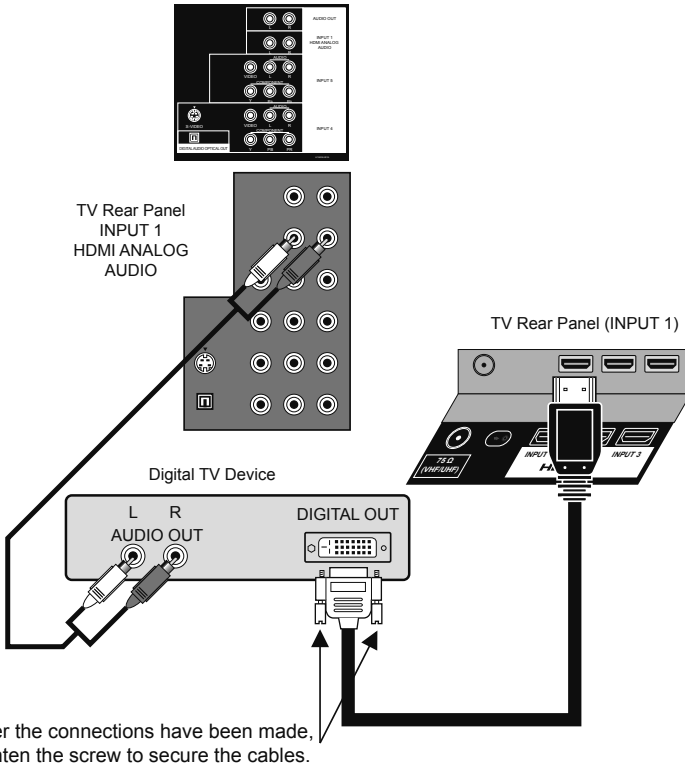

### Notes:

- To watch your Digital TV device, make sure your TV is displaying INPUT 1 by pressing the **V1** button on your remote control.
- This TV can accept 480i, 480p, 720p, 1080i and 1080p signals via HDMI.
- The INPUT 1 HDMI ANALOG AUDIO input can only be used with INPUT 1.

# Connecting Your Devices

## Connect a Blu-ray, HD DVD Player or HDMI Device

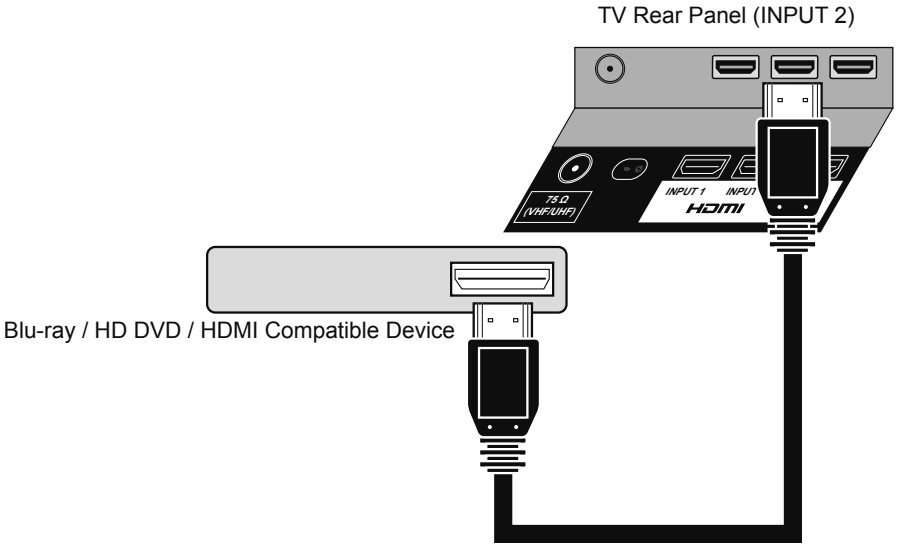

### Notes:

- To watch your Blu-ray, HD DVD or HDMI device, make sure your TV is displaying INPUT 1, INPUT 2 or INPUT 3 by pressing the **V1**, **V2** or **V3** button on your remote control.
- Some decoders may not respond depending on the equipment that is connected to the HDMI.
- This TV can accept 480i, 480p, 720p, 1080i and 1080p signals via HDMI.
- This JVC television can accept a variety of HD signals, including 720/60p, 1080/60i and 1080/60p. It does not accept a 1080/24p signal. Please note that in some cases, a Blu-ray or HD DVD may only offer the choice of 1080/60i or 1080/24p. In this case, it is necessary to choose the 1080/60i output. Please refer to your Blu-ray / HD-DVD manual for complete details on choosing the correct output.
- Some HDMI Output Devices may fail to detect this TV as a 1080p device. If this occurs, manually select 1080p on the HDMI Output Device.

# Troubleshooting

Refer to the table below to check the condition. If you think that there is a problem, contact the JVC Service Center where you purchased the television.

PROBLEMS	CHECK
There is no power	<ul style="list-style-type: none"> <li>• See if the power cord became unplugged.</li> <li>• Check for a blown fuse or circuit breaker or a power outage.</li> </ul>
There is no picture or sound	<ul style="list-style-type: none"> <li>• The antenna could be disconnected.</li> <li>• The tuner could be set improperly. See page 40.</li> <li>• The TV station may be having difficulties. Check to see if other stations are working.</li> <li>• Use the HDMI cable with HDMI logo <b>HDMI</b>. See page 46.</li> <li>• If you have a device connected to INPUT-1, INPUT-2 or INPUT-3, you will not be able to hear any audio from the AUDIO OUT on the back of the TV.</li> <li>• You cannot output audio using the DIGITAL AUDIO OPTICAL OUTPUT when you have digital sound from an HDMI device connected to the INPUT-1, INPUT-2 or INPUT-3 connection on the back of the TV.</li> <li>• This TV can accept 480i (Composite / S / HDMI / Component), 480p, 720p, 1080i and 1080p signals. Please check your settings.</li> </ul>
Remote control is not operating properly or at all	<ul style="list-style-type: none"> <li>• Check to see that the batteries are still working and properly installed.</li> <li>• Make sure the remote has a clear sight path to the TV.</li> <li>• You may be too far from the TV. You must be within 23 feet (7 meters).</li> </ul>
The power turns off by itself	<ul style="list-style-type: none"> <li>• Make sure the set did not become unplugged.</li> <li>• Perhaps the Auto Shut Off is set. See page 41.</li> <li>• Check to see if the Sleep Timer was set. See page 39.</li> </ul>
It does not operate correctly	<ul style="list-style-type: none"> <li>• This television is operated by a microprocessor. It is possible that external noise or interference is causing the problem. If the television does not function correctly, remove the electrical plug from the wall outlet and wait a while before inserting it into the wall outlet again and operating the television.</li> </ul>
The color quality is poor	<ul style="list-style-type: none"> <li>• Tint and Color may be improperly adjusted. See page 24.</li> <li>• The Video Status mode may be turned to the wrong setting. See page 23.</li> </ul>
There are lines across the picture	<ul style="list-style-type: none"> <li>• There could be interference from another electrical appliance, such as a computer, another TV or VCR. Move any such appliances further away from the TV.</li> </ul>
The picture is spotted	<ul style="list-style-type: none"> <li>• There could be interference from a high-wattage appliance, like a hairdryer or vacuum, operating nearby. Move the antenna away from the appliance or change to a coaxial cable connection which is less prone to interference.</li> </ul>
There are double pictures (ghosts)	<ul style="list-style-type: none"> <li>• A building or passing airplane can reflect the original signal and produce a second, slightly delayed one. Adjust your antenna position.</li> </ul>
Picture is snowy (image noise)	<ul style="list-style-type: none"> <li>• Your antenna may be damaged, disconnected or turned. Check the antenna connection. If the antenna is damaged, replace it.</li> </ul>

# Troubleshooting

PROBLEMS	CHECK
Screen is 80% black	<ul style="list-style-type: none"> <li>The Closed Caption Text mode is on. Turn it off in the Closed Caption Menu, page 29.</li> </ul>
Stereo or bilingual programs can't be heard	<ul style="list-style-type: none"> <li>Make sure the MTS settings are correct. See page 37.</li> </ul>
Static electricity	<ul style="list-style-type: none"> <li>It is normal to feel static electricity if you brush or touch the screen.</li> </ul>
You hear occasional crackling sounds	<ul style="list-style-type: none"> <li>It is normal for the TV to make crackling sounds when first turned on or off. Unless the sound or picture become abnormal, this is fine.</li> </ul>
The picture is slightly cut off when you use 1080p format only	<ul style="list-style-type: none"> <li>Change the picture format setting on your external device to 1080i or other resolution.</li> </ul>
The screen disappears except for the menu screen	<ul style="list-style-type: none"> <li>This occurs when you select a digital menu when your input source is from the HDMI connection. Press the menu button.</li> </ul>
My HDMI device doesn't work or doesn't work properly	<ul style="list-style-type: none"> <li>This JVC television can accept a variety of HD signals, including 720/60p, 1080/60i and 1080/60p. It does not accept a 1080/24p signal. Please note that in some cases, a Blu-ray or HD-DVD may only offer the choice of 1080/60i or 1080/24p. In this case, it is necessary to choose the 1080/60i output. Please refer to your Blu-ray/HD-DVD manual for complete details on choosing the correct output.</li> </ul>
"Weak Signal" appears	<ul style="list-style-type: none"> <li>This OSD appears when the digital channel that you have selected is too weak to receive or no signal is being detected for that channel.</li> </ul>
"No Program" appears	<ul style="list-style-type: none"> <li>It appears when that channel is not receiving a signal and you have the Noise Muting function OFF and you have a single screen. It moves automatically every two seconds to prevent the screen from burn-in.</li> <li>Even if "NO PROGRAM" appears on the screen, your timer functions and auto shut off functions that you set, are still active.</li> <li>If you are watching an analog channel, NO PROGRAM does not appear.</li> </ul>

## The following are not malfunctions.

- The television may make a creaking sound if the temperature of the room or the temperature of the inside of the television changes. If there is no problem with the screen or sound, then there is no need to worry.
- The picture may be temporarily disturbed and noise may be seen on the screen if the power is turned on immediately after it has been turned off. This is not a malfunction.



# Specifications

Model	LT-42X579 LT-42EM59	LT-47X579 LT-47EM59
Type	LCD Flat Television	
Reception Format	NTSC, BTSC System (Multi-Channel Sound) ATSC Terrestrial, Digital Cable	
Reception Range	VHF 2 to 13, UHF 14 to 69 at ATSC, CATV 135 Sub, Mid, Super, Hyper and Ultra bands at Digital Cable	
	VHF 2 to 13, UHF 14 to 69 CATV 125 Sub, Mid, Super, Hyper and Ultra bands (191 channel frequency synthesizer system) at Analog • Reception of channel A-5 ("95" of the TV set's on-screen cable channel numbers) is not recommended for your TV set.	
Power Source	AC 120V, 60 Hz	
Power Consumption	247W	274W
Screen Size	42 inch / 106.7 cm measured diagonally, 16:9 ratio	47 inch / 119.4 cm measured diagonally, 16:9 ratio
Audio Output	10W + 10W	
Speakers	4 x 16cm Oblique x 2	
Antenna Terminal (VHF/UHF, ATSC/DIGITAL CABLE IN)	75 ohms (VHF/UHF)(F-type connector)	
Input 4, 5 Terminal	480i S (Input 4) Y: 1 Vp-p positive, 75 ohms (negative sync provided) C: 0.286 Vp-p (burst signal), 75 ohms Video: 1 Vp-p, 75 ohms Audio: 500 mVrms (-4dBs) high impedance	
Input 4, 5 Terminal (Component Terminal)	1080i / 720p / 480p / 480i Y: 1 Vp-p positive, 75 ohms (negative sync provided) Pb/Ps: 0.7 Vp-p 75 ohms	
Input 1, 2, 3 Terminal (HDMI Input Terminal)	Video: 1080p / 1080i / 720p / 480p / 480i Audio: 2ch PCM, 32 / 44.1 / 48 KHz 16 / 20 / 24 bit	
Audio Output Jacks (FIX)	FIX : 500mVrms (-4dBs), Low Impedance	
Optical Output Digital Audio	Digital Out (optical) x 1	
Dimensions (inch/mm) W X H X D	40 x 29 x 11 3/4 (with stand) 1014 x 733.7 x 296 (with stand)	44 3/8 x 31 1/2 x 11 3/4 (with stand) 1127 x 799.7 x 296 (with stand)
	40 x 26 3/4 x 4 3/4 (without stand) 1014 x 677.2 x 117.8 (without stand)	44 3/8 x 29 3/8 x 4 3/4 (without stand) 1127 x 743.2 x 117.8 (without stand)
Weight (lbs / kg)	56.1 / 25.5 (with stand)	63.1 / 28.7 (with stand)
	51.7 / 23.5 (without stand)	58.7 / 26.7 (without stand)

## Specifications subject to change without notice.

- The open source software is embedded in this product. For more information, please go to:  
[http://software.jvc.com/opensource/lnx/DP/08\\_AtscQam\\_T/download.html](http://software.jvc.com/opensource/lnx/DP/08_AtscQam_T/download.html)



# LIMITED WARRANTY

COLOR TV 1-1

For Canadian model televisions, see separate sheets for Canadian Warranty information.

JVC COMPANY OF AMERICA (JVC) warrants this product and all parts thereof, except as set forth below ONLY TO THE ORIGINAL RETAIL PURCHASER to be FREE FROM DEFECTIVE MATERIALS AND WORKMANSHIP from the date of original purchase for the period shown below. ("The Warranty Period")  
FOR DIRECT-VIEW COLOR TELEVISION, PICTURE TUBE is covered for Two(2)years.

Parts	<b>1 YEAR</b>	Labor	<b>1 YEAR</b>
-------	---------------	-------	---------------

**THIS LIMITED WARRANTY IS VALID ONLY IN THE FIFTY (50) UNITED STATES, THE DISTRICT OF COLUMBIA AND IN THE COMMONWEALTH OF PUERTO RICO.**

**WHAT WE WILL DO:**

If this product is found to be defective within the warranty period, JVC will repair or replace defective parts with new or rebuilt equivalents at no charge to the original owner. Such repair and replacement services shall be rendered by JVC during normal business hours at JVC authorized service centers. Parts used for replacement are warranted only for the remainder of the Warranty Period. All products may be brought to a JVC authorized service center on a carry-in basis. Color televisions with a screen size of 27" or greater qualify for in-home service. In such cases, a technician will come to your home and either repair the TV there or remove and return it if it cannot be repaired in your home.

**WHAT YOU MUST DO FOR WARRANTY SERVICE:**

*Please do not return your product to the retailer*  
Instead, return your product to the JVC authorized service center nearest you. If shipping the product to the service center, please be sure to package it carefully, preferably in the original packaging, and include a brief description of the problem(s). Please call 1-800-252-5722 to locate the nearest JVC authorized service center. Service locations can also be obtained from our website <http://www.jvc.com>. If your product qualifies for in-home service, the service representative will require clear access to the product.

If you have any questions concerning your JVC Product, please contact our Customer Care Center at 800-252-5722

**WHAT IS NOT COVERED:**

- This limited warranty provided by JVC does not cover:
1. Products which have been subject to abuse, accident, alteration, modification, tampering, negligence, misuse, faulty installation, lack of reasonable care, or if repaired or serviced by anyone other than a service facility authorized by JVC to render such service, or if affixed to any attachment not provided with the products, or if the model or serial number has been altered, tampered with, defaced or removed;
  2. Initial installation, installation and removal from cabinets or mounting systems.
  3. Operational adjustments covered in the Owner's Manual, normal maintenance, video and audio head cleaning;
  4. Damage that occurs in shipment, due to act of God, and cosmetic damage;
  5. Signal reception problems and failures due to line power surge;
  6. Video Pick-up Tubes/CDD Image Sensors are covered for 90 days from the date of purchase;
  7. Accessories;
  8. Batteries (except that Rechargeable Batteries are covered for 90 days from the date of purchase);
  9. Products used for commercial purposes, including, but not limited to rental.

There are no express warranties except as listed above.

THE DURATION OF ANY IMPLIED WARRANTIES, INCLUDING THE IMPLIED WARRANTY OF MERCHANTABILITY, IS LIMITED TO THE DURATION OF THE EXPRESS WARRANTY HEREIN.

JVC SHALL NOT BE LIABLE FOR ANY LOSS OF USE OF THE PRODUCT, INCONVENIENCE, OR ANY OTHER DAMAGES, WHETHER DIRECT, INCIDENTAL OR CONSEQUENTIAL (INCLUDING, WITHOUT LIMITATION, DAMAGE TO TAPES, RECORDS OR DISCS) RESULTING FROM THE USE OF THIS PRODUCT, OR ARISING OUT OF ANY BREACH OF THIS WARRANTY. ALL EXPRESS AND IMPLIED WARRANTIES, INCLUDING THE WARRANTIES OF MERCHANTABILITY AND FITNESS FOR PARTICULAR PURPOSE, ARE LIMITED TO THE WARRANTY PERIOD SET FORTH ABOVE.

Some states do not allow the exclusion of incidental or consequential damages or limitations on how long an implied warranty lasts, so these limitations or exclusions may not apply to you. This warranty gives you specific legal rights and you may also have other rights which vary from state to state.

JVC COMPANY OF AMERICA  
DIVISION OF JVC AMERICAS CORP.

1700 Valley Road  
Wayne, NJ 07470

<http://www.jvc.com>

REFURBISHED PRODUCTS CARRY A SEPARATE WARRANTY, THIS WARRANTY DOES NOT APPLY. FOR DETAIL OF REFURBISHED PRODUCT WARRANTY, PLEASE REFER TO THE REFURBISHED PRODUCT WARRANTY INFORMATION PACKAGED WITH EACH REFURBISHED PRODUCT.

**For customer use:**

Enter below the Model No. and Serial No. which is located either on the rear, bottom or side of the cabinet. Retain this information for future reference.

Model No. : \_\_\_\_\_

Serial No. : \_\_\_\_\_

Purchase date : \_\_\_\_\_

Name of dealer : \_\_\_\_\_

# **TO OUR VALUED CUSTOMER** ———

THANK YOU FOR PURCHASING THIS JVC PRODUCT.  
WE WANT TO HELP YOU ACHIEVE A PERFECT EXPERIENCE.

**NEED HELP ON HOW TO HOOK UP?  
NEED ASSISTANCE ON HOW TO OPERATE?  
NEED TO LOCATE A JVC SERVICE CENTER?  
LIKE TO PURCHASE ACCESSORIES?**

**JVC<sup>®</sup> IS HERE TO HELP!**  
**TOLL FREE: 1(800)252-5722**  
**<http://www.jvc.com>**

Remember to retain your Bill of Sale for Warranty Service.

————— **Do not attempt to service the product yourself** —————

### **Caution**

To prevent electrical shock, do not open the cabinet.  
There are no user serviceable parts inside.  
Please refer to qualified service personnel for repairs.

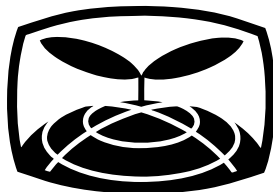

JVC Loves the Earth

**JVC COMPANY OF AMERICA**  
Division of JVC Americas Corp.  
1700 Valley Road  
Wayne, New Jersey, 07470

**JVC<sup>®</sup>**

**JVC CANADA, INC.**  
21 Finchdene Square  
Scarborough, Ontario  
Canada, M1X 1A7